

**Proceedings of the thirty-third
Western Conference
On Linguistics**

Volume sixteen

WECOL 2004

Edited by

Michal Temkin Martínez

Asier Alcázar

Roberto Mayoral Hernández

*Linguistics Department,
University of Southern California*

**Department of Linguistics
California State University, Fresno
Fresno, California 93740-8001**

Copyright © 2006 by the Department
of Linguistics California State
University, Fresno

“The Distribution of Null C Clauses
and the PF Relevance of Phases”
Copyright © 2006 by Duk-Ho An

“Partial Identity Avoidance as
Cooperative Interaction” Copyright ©
2006 by Eric Baković

“Semantic Underspecificity in
English Argument/Oblique
Alternations” Copyright © 2006 by
John Beavers

“Some Speculations on the Noun
Phrase Structure of Jingpo”
Copyright © 2006 by Candice
Cheung Chi Hang

“Focus ‘-ka’ in Korean: A Base-
Generated Approach” Copyright ©
2006 by Sae-Youn Cho

“Is Impersonal *si* in Italian Definite or
Indefinite?” Copyright © 2006 by
Roberta D’Alessandro

“Event-Path Homomorphism and the
Accompanied-Motion Reading in
Motion Causatives” Copyright ©
2006 by Raffaella Folli and Heidi
Harley

“An Argument for a Presuppositional
Treatment of Neg-Raising Predicates”
Copyright © 2006 by Jon Gajewski

“Why English and Korean
Resultative Constructions Differ”
Copyright © 2006 by Soo-Min Hong

“Cross-Category Phonological
Contrast as a Result of
Morphological Marking” Copyright
© 2006 by Cristian Iscrulescu

“The Interpretation of Pronouns
and Reflexives in Picture Noun
Phrases: Effects of Non-structural
Factors” Copyright © 2006 by Elsi
Kaiser, Jeffrey T. Runner, Rachel
S. Sussman and Michael K.
Tanenhaus

“The Syntactic Visibility of
Intentionality: Evidence from
Dyadic Unaccusatives” Copyright
© 2006 by Dalina Kallulli

“Phonological Systems in
Bilinguals: Age of Learning Effects
on the Stop Consonant Systems of
Korean-English Bilinguals”
Copyright © 2006 by Kyoung-Ho
Kang and Susan G. Guion

“A Case-study on the Accusative
Case in Turkish” Copyright © 2006
by F. Nihan Ketrez

“Comp-trace Effects are EPP-
driven: The Role of Anti-locality”
Copyright © 2006 by George
Kotzoglou

“A Semantic and Syntactic
Analysis of Vietnamese
Causatives” Copyright © 2006 by
Nayoung Kwon

“Mixed clitic placement: evidence
from Romanian” Copyright © 2006
by Ana R. Luís

“Non-reflexive Non-argumental
Clitic Pronouns of Spanish”
Copyright © 2006 by Jonathan E.
MacDonald

“Non-canonical A-Positions &
Possession” Copyright © 2006 by
Andrew Gordon Middleton

“Emergent Features: Evidence from
Natural Classes in 561 Languages”
Copyright © 2006 by Jeff Mielke

“Asymmetry in Double-object
Constructions in Turkish” Copyright
© 2006 by Balkız Öztürk

“Agreement of Sentence Final
Particles in Jussive Clauses”
Copyright © 2006 by Miok Debby
Pak

“The Group Interpretation of Plural
Indefinite Descriptions with *unos*”
Copyright © 2006 by Helena López
Palma

“The Rise of the Suffixal Article in
the Early North Germanic
DP” Copyright © 2006 by Dorian
Roehrs and Christopher D. Sapp

“Non-verbal Predicates and the
Distribution of *Ser* and *Estar* in
Spanish” Copyright © by Isabelle
Roy

“Dominance, Markedness Reversal
and the Role of Local Conjunction: a
Case Study of Kinande” Copyright ©
2006 by Tomomasa Sasa

“On the Durational Variability of
Svarabhakti Vowels in Spanish
Complex Onsets” Copyright ©
2006 by Benjamin Schmeiser

“Extended-Projection,
Categorization, and the English
Morpheme -Ing” Copyright ©
2006 by David Schueler

“Are Scalar Implicatures Computed
Online?” Copyright © 2006 by
Gianluca Storto and Michael K.
Tanenhaus

“Two Types of Relative Clauses in
Slavic – Evidence from
Reconstruction and Ellipsis”
Copyright © 2006 by Adam
Szczegielniak

“Manipulation of Verbal Inflection
in English and Spanish
Spontaneous Speech Errors”
Copyright © 2006 by Ellen
Thompson

“Torne Sámi Causatives: A
Reconsideration of Faire Par”
Copyright © 2006 by Mikael Vinka

“Nominal Appositives in Context”
Copyright © 2006 by Linton Wang,
Eric McCready and Brian Reese

“Expletives Move!” Copyright ©
2006 by Masashi Nomura (This
paper was presented in 2003, and is
reprinted in this volume.)

ISBN 1-879890-15-1

Contents

The Distribution of Null C Clauses and the PF Relevance of Phases.....	1
<i>Duk-Ho An</i>	
Partial Identity Avoidance as Cooperative Interaction	13
<i>Eric Baković</i>	
Semantic Underspecificity in English Argument/Oblique Alternations	26
<i>John Beavers</i>	
Some Speculations on the Noun Phrase Structure of Jingpo	38
<i>Candice Cheung Chi Hang</i>	
Focus ‘-ka’ in Korean: A Base-Generated Approach.....	52
<i>Sae-Youn Cho</i>	
Is Impersonal <i>si</i> in Italian Definite or Indefinite?	64
<i>Roberta D’Alessandro</i>	
Event-Path Homomorphism and the Accompanied-Motion Reading in Motion Causatives	76
<i>Raffaella Folli and Heidi Harley</i>	
An Argument for a Presuppositional Treatment of Neg-Raising Predicates	88
<i>Jon Gajewski</i>	
Why English and Korean Resultative Constructions Differ	100
<i>Soo-Min Hong</i>	
Cross-Category Phonological Contrast as a Result of Morphological Marking	112
<i>Cristian Iscrulescu</i>	

The Interpretation of Pronouns and Reflexives in Picture Noun Phrases: Effects of Non-structural Factors	122
<i>Elsi Kaiser, Jeffrey T. Runner, Rachel S. Sussman and Michael K. Tanenhaus</i>	
The Syntactic Visibility of Intentionality: Evidence from Dyadic Unaccusatives	135
<i>Dalina Kallulli</i>	
Phonological Systems in Bilinguals: Age of Learning Effects on the Stop Consonant Systems of Korean-English Bilinguals	147
<i>Kyoung-Ho Kang and Susan G. Guion</i>	
A Case-study on the Accusative Case in Turkish	163
<i>F. Nihan Ketrez</i>	
Comp-trace Effects are EPP-driven: The Role of Anti-locality..	174
<i>George Kotzoglou</i>	
A Semantic and Syntactic Analysis of Vietnamese Causatives ..	186
<i>Nayoung Kwon</i>	
Mixed clitic placement: evidence from Romanian	199
<i>Ana R. Luís</i>	
Non-reflexive Non-argumental Clitic Pronouns of Spanish	212
<i>Jonathan E. MacDonald</i>	
Non-canonical A-Positions & Possession	226
<i>Andrew Gordon Middleton</i>	
Emergent Features: Evidence from Natural Classes in 561 Languages	236
<i>Jeff Mielke</i>	

Asymmetry in Double-object Constructions in Turkish	248
<i>Balkız Öztürk</i>	
Agreement of Sentence Final Particles in Jussive Clauses	263
<i>Miok Debby Pak</i>	
The Group Interpretation of Plural Indefinite Descriptions with <i>unos</i>	275
<i>Helena López Palma</i>	
The Rise of the Suffixal Article in the Early North Germanic DP	290
<i>Dorian Roehrs and Christopher D. Sapp</i>	
Non-Verbal Predicates and the Distribution of <i>Ser</i> and <i>Estar</i> in Spanish	302
Dominance, Markedness Reversal and the Role of Local Conjunction: a Case Study of Kinande	317
<i>Tomomasa Sasa</i>	
On the Durational Variability of Svarabhakti Vowels in Spanish Complex Onsets	330
<i>Benjamin Schmeiser</i>	
Extended-Projection, Categorization, and the English Morpheme <i>-Ing</i>	342
<i>David Schueler</i>	
Are Scalar Implicatures Computed Online?	357
<i>Gianluca Storto and Michael K. Tanenhaus</i>	
Two Types of Relative Clauses in Slavic – Evidence from Reconstruction and Ellipsis	373
<i>Adam Szczegielniak</i>	

Manipulation of Verbal Inflection in English and Spanish Spontaneous Speech Errors	385
<i>Ellen Thompson</i>	
Torne Sámi Causatives: A Reconsideration of <i>Faire Par</i>	399
<i>Mikael Vinka</i>	
Nominal Appositives in Context	411
<i>Linton Wang, Eric McCready and Brian Reese</i>	
Expletives Move!	424
<i>Masashi Nomura</i>	

The Distribution of Null C Clauses and the PF Relevance of Phases

Duk-Ho An

University of Connecticut

1. Introduction

I propose in this paper that consideration of the mapping from syntax to phonology at the PF interface allows us to explain the distribution of clauses headed by a null complementizer (C) in English (Stowell 1981, Webelhuth 1989, Bošković 1997, Richards 1999, Pesetsky and Torrego 2001, Bošković and Lasnik 2003, and An, to appear).¹ Specifically, I argue that assignment of intonational phrases (I-phrases) plays an important role in determining the distribution of the relevant null C clauses. To this end, it is shown that a careful re-examination of the relevant data leads us to two new generalizations: (i) all the relevant clauses are obligatorily parsed as separate I-phrases and (ii) not only the null C but also the null SpecCP plays a role in determining the distribution of the relevant clauses. It is argued that a mismatch between the boundaries of certain prosodic units that results from the null periphery (i.e., null SpecCP and C) of the relevant syntactic constituent is responsible for the deviance of the null C clauses. In addition, I will also discuss the implications of the current analysis on the nature of the new notion of locality *phase* proposed by Chomsky (2000, 2001). While the discussion of this latter issue is somewhat speculative, I will suggest that the notion of phase (or its instantiation as the Phase Impenetrability Condition) reflects a more general property of the derivation, namely, edge-sensitivity.

This paper is organized as follows: in section 2, I briefly illustrate the question raised by the distribution of null C clauses in English; in section 3, I propose two new generalizations based on a re-examination of the relevant data; in section 4, I provide a novel account of the distribution of null C clauses; in section 5, I discuss the implications of the current analysis; section 6 concludes.

2. Distribution of Null C Clauses

In this section I illustrate the basic distribution of null C clauses in English. Consider the following data:

- (1) a. I believe [_{CP} that [_{IP} John liked linguistics]]
 b. I believe [_{CP} ∅ [_{IP} John liked linguistics]]
 (2) a. I believe very strongly [_{CP} that [_{IP} John liked linguistics]]
 b. * I believe very strongly [_{CP} ∅ [_{IP} John liked linguistics]]

The grammaticality of the sentences in (1) shows that an overt C is optional if the clausal complement is adjacent to the verb. However, if the clausal complement is separated from the verb, an overt C is obligatory, as the contrast between (2a) and (2b) shows. Let us look at more data that illustrate the same point.

- (3) a. [_{CP} That [_{IP} the teacher was lying]] was hardly obvious
 b. * [_{CP} ∅ [_{IP} the teacher was lying]] was hardly obvious
 (4) a. [_{CP} That [_{IP} the teacher was lying]], Ben already knew
 b. * [_{CP} ∅ [_{IP} the teacher was lying]], Ben already knew
 (5) a. I distrust [_{NP} the claim [_{CP} that [_{IP} Bill had left the party]]]
 b. * I distrust [_{NP} the claim [_{CP} ∅ [_{IP} Bill had left the party]]]

The data in (3-5) show that a null C clause is disallowed in subject position, topicalized position, and complement position of a noun. For ease of exposition, I will restrict the discussion to these basic examples, referring the reader to An, to appear, and Bošković and Lasnik 2003 for further data and discussion. In the following section, I will show that a closer examination of the above data reveals two important properties of the null C clauses, which will play a central role in the current analysis.

3. New Generalizations

This section examines the above data more closely and proposes new generalizations about them. More concretely, it will be shown that not just null C, but also null SpecCP is relevant, and that the clauses in question are all obligatorily parsed as separate I-phrases. These two properties will play a central role in the discussion in section 4, where an alternative analysis is proposed.

3.1 Relevance of SpecCP

Let us start by pointing out that most of the existing analyses of the distribution of null C clauses rely on some licensing condition of the null C. For example, Stowell (1981) argues that null C has to satisfy the ECP; Bošković and Lasnik (2003) argue that null C is an affix that requires a host under adjacency (see also Richards 1999).² Therefore, they attribute the ill-formedness of the null C clauses to the failure of licensing of null C. However, when we look at the basic data more carefully, we find that the relevant clauses are missing not just an

overt C, but also an overt SpecCP. In other words, none of the null C clauses have an overt SpecCP.³ I repeat the relevant examples below.

- (6) a. * I believe very strongly [John liked linguistics]
 b. * [The teacher was lying] was hardly obvious
 c. * [The teacher was lying], Ben already knew
 d. * I distrust the claim [Bill had left the party]

Note that there is nothing in the specifier position of these CPs. One might think that this is merely an accident. However, I argue that there is a reason to believe that the null SpecCP is indeed relevant. Consider the following data:

- (7) a. the child [who Mary was waiting for]
 b. the child [Mary was waiting for]
 c. the train [that Mary was waiting for]
 d. the train [Mary was waiting for]

(7a) and (7c) show that either the specifier or head of a relative clause can be null. It is also possible to leave the two positions empty at the same time, as in (7b,d). Note that the relevant CP is adjacent to the head noun in all these cases. However, when the CP is separated from the head noun, one of the two positions, i.e., SpecCP or C, must be overt.

- (8) a. I saw the child yesterday [who Mary was waiting for]
 b. ?* I saw the child yesterday [Mary was waiting for]
 c. I saw the train yesterday [that Mary was waiting for]
 d. ?* I saw the train yesterday [Mary was waiting for]

In (8), the relevant CP is extraposed. Here, the contrast between (8c) and (8d) illustrates the basic pattern where an overt C improves the ungrammatical sentence. The crucial point is illustrated by the contrast between (8a) and (8b). Notice that these CPs are headed by a null C and are separated from the head noun, while the SpecCP is overtly filled only in the grammatical sentence in (8a). Therefore, the contrast between (8a) and (8b) suggests that an overt SpecCP can play the same role as an overt C. Based on this, I propose the following generalization:

- (9) **Non-null Spec-Head Generalization**
 The specifier and the head of a clause in extraposed position, subject position, topicalized position, and complement position of a noun cannot be null at the same time

3.2 Relevance of I-phrases

In this section, I show that there is another shared property between the relevant null C clauses. That is, they are all obligatorily parsed as separate I-phrases.⁴ In order to show this, I rely on the analysis of the placement of Serbo-Croatian (SC) second position enclitics, since their behavior shows the interaction between syntax and phonology in a straightforward way (Bošković 2001, Browne 1974, Ćavar and Wilder 1993, Halpern 1992, Progovac 1996, Radanović-Kocić 1988, 1996, Schütze 1994, Stjepanović 1999, Wilder and Ćavar 1994, and Zec and Inkelas 1990). First of all, regarding the behavior of the relevant clitics, I adopt the following generalization:

- (10) SC clitics occur in the second position of their I-phrase
(Bošković 2001:64, Radanović-Kocić 1988)

Assuming (10), consider the following example:

- (11) a. Da Ivan voli Mariju # jasno **mi je** (# - I-phrase boundary)
that Ivan loves Marija clear me is
'That Ivan loves Marija is clear to me'
b. ?* Da Ivan voli Mariju # **mi je** jasno (Browne 1975:121)

In (11), a CP appears in the subject position. Note that the clitics cannot immediately follow the clausal subject, as the ungrammaticality of (11b) indicates. However, if the clitics are preceded by exactly one element after the clausal subject, the sentence is grammatical, as in (11a). This contrast is correctly captured by the generalization in (10) if we assume that the clausal subject is obligatorily parsed as a separate I-phrase.

Next, let us examine topicalization constructions.

- (12) a. Lingvistika **će** rešavati svoje probleme i dileme
linguistics will solve its problems and dilemmas
'Linguistics will solve its problems and dilemmas.'
b. Svoje probleme i dileme # lingvistika **će** rešavati
its problems and dilemmas linguistics will solve
c. * Svoje probleme i dileme # **će** lingvistika rešavati (Schütze 1994:450)

(12b,c) are derived from (12a) by topicalization. Note that the clitic cannot immediately follow the topicalized element. However, if the clitic is preceded by exactly one element after the topicalized element, the sentence is ruled in, as in (12b). Again, this contrast is correctly captured by (10) under the standard assumption that topicalized elements are obligatorily parsed as a separate I-phrase.

Next, let us consider complement clauses of a noun.

- (13) a. *Želja # dati joj ružu .. (bila je velika)*⁵
 wish give her rose been is great
 ‘The desire to give her a rose was great.’
 b. * *Želja # joj dati ružu .. (bila je velika)* (Ćavar and Wilder 1993:11)

Here, the clitic cannot be the first element within the clausal complement. This is also predicted by (10) if we assume that the relevant CP is obligatorily parsed as a separate I-phrase.⁶

I do not have an example of extraposition in SC. However, it is a standard assumption in the literature that extraposed elements are obligatorily parsed as a separate I-phrase (Chen 1990, Hale and Selkirk 1987, Nespov and Vogel 1986, Selkirk 1978, Stowell 1981, Zec and Inkelas 1990). For instance, extraposed elements are typically preceded by a pause and are subject to certain heaviness requirements, which are characteristic of I-phrases.

Based on this, I argue that in addition to having null SpecCP and C, the relevant null C clauses share the property of being a separate I-phrase.⁷ In the following section, I propose an alternative analysis of the distribution of null C clauses based on these generalizations.

4. Proposal

In section 3, we have observed that the relevant clauses share two important properties: (i) they have a null SpecCP and C; (ii) they are obligatorily parsed as separate I-phrases. In this section, I argue that these two properties are interwoven to yield the ungrammaticality of the relevant clauses. To this end, it is important to understand the nature of the mapping from syntax to phonology, which I briefly summarize below.

First, it is a standard assumption in the literature that there is a process of prosodic mapping which mediates syntax and phonology (Chen 1990, Nespov and Vogel 1986, Schütze 1994, Selkirk 1978, 1984, 1986, Zec and Inkelas 1990). Prosodic mapping is a process that takes syntactic structure as input and computes a corresponding prosodic structure. Here, I adopt Selkirk’s (1978, 1984, 1986) proposal that prosodic structure consists of several distinct categories such as syllable, foot, prosodic word, I-phrase, and utterance (Nespov and Vogel 1986).⁸ These categories are organized in a hierarchical order and, for any prosodic category, a sentence is exhaustively parsed into a sequence of such category. For example, at the I-phrase level, a sentence is parsed into a sequence of I-phrases. Each I-phrase is again exhaustively parsed into a sequence of prosodic words.

- (14) [... ..] Utterance
 [... ..][... ..] I-phrase
 [...][... ..][...][... ..] prosodic words
 [...][...][...][...][...][... ..] foot, syllable

Assuming this hierarchical organization of prosodic categories, I crucially adopt Nespor and Vogel's (1986) and Schütze's (1994) claim that I-phrasing must occur at the juncture between prosodic words. In other words, the boundary of an I-phrase must coincide with the boundary of a prosodic word.⁹ In addition, I assume that I-phrasing is dependent on the syntactic structure. More specifically, I assume that the boundary of an I-phrase assigned to a CP should coincide with the syntactic boundary of the CP.

Given this set of assumptions, we can explain the distribution of the relevant null C clauses. First, recall that they are obligatorily parsed as separate I-phrases. In addition, recall that they all contain null SpecCP and C at the same time. This state of affairs entails that the boundary of the I-phrase assigned to the relevant CPs cannot coincide with the boundary of the prosodic word within the I-phrase. Recall that, as mentioned in note 8, prosodic words are defined as phonologically independent words that can bear stress. Assuming that the boundary of an I-phrase is dependent on the syntactic boundary of the relevant constituent, if a CP that is parsed as a separate I-phrase contains null SpecCP and C, then a mismatch will arise between the boundary of the I-phrase and that of the prosodic word within the I-phrase. This situation can be represented as follows:

- (15) *I saw the child yesterday [_{CP} ∅ ∅ [_{IP} John likes]]
 ↑ mismatch ↑
 I-phrase prosodic word
 boundary boundary

Therefore, it follows that if a CP is parsed as a separate I-phrase, the specifier and head of the CP cannot both be empty. I summarize this situation as the following generalization:

- (16) Intonational Phrase Edge Generalization (IPEG)
 The edge of an I-phrase cannot be empty
 (where the notion edge embraces the specifier and head of the relevant syntactic constituent)

Based on this, I argue that the deviance of the relevant null C clauses can be attributed to the mismatch of the sort illustrated in (15).

The current analysis also explains straightforwardly why null operator nonrestrictive relative clauses are not allowed, as shown by (17b).

- (17) a. John, who Mary likes, didn't come to the party
 b. *John, Op Mary likes, didn't come to the party

Under the standard assumption that nonrestrictive relative clauses are parsed as separate I-phrases, the contrast between (17a) and (17b) is easily captured by the IPEG, since the relevant clause in (17b) contains a null SpecCP and C.

5. Speculations on the Nature of Phases

In this section I speculate on the nature of the notion of phase, especially its implementation as the Phase Impenetrability Condition (PIC), in relation to the current analysis. Below, I give a version of the PIC.

- (18) Phase Impenetrability Condition
 In phase α with head H, the domain of H is not accessible to operations outside α , but only H and its specifier (Chomsky 2000:108)

Note that the PIC gives special status to the specifier and head of a constituent that is a phase. Given this, it is interesting to note that the generalization in (16) bears some resemblance to (18) in that the former also makes reference to the specifier and head of a syntactic constituent that is to be parsed as an I-phrase. Recall that all the relevant clauses analyzed in the previous section involve a CP, which is standardly assumed to be a phase. This state of affairs seems to fit very well into the following quote from Nespor and Vogel 1986:

Syntactic cyclic nodes are relevant constituents in the process of prosodic mapping from syntax to phonology, in particular, in the process of division of a sentence into a sequence of intonational phrases.

Given this parallelism, it will be interesting to examine the behavior of other phases with respect to (16). In particular, I examine the behavior of vPs below, which are usually assumed to be phases. More concretely, I will examine VP-fronting.¹⁰ First, there is evidence that VP-fronted material is parsed as a separate I-phrase. Consider the following SC data:

- (19) a. [_{VP} Dali ga Mariji] # Ivan i Stipe **su**
 given it to Marija Ivan and Stipe did
 'Give it to Marija, Ivan and Stipe did'
 b. ??[_{VP} Dali ga Mariji] # **su** Ivan i Stipe
 given it to Marija did Ivan and Stipe (Bošković 2001:88)

Bošković (2001) argues that the ungrammaticality of (19b) follows from the generalization in (10), repeated below.

- (10) SC clitics occur in the second position of their I-phrase

In (18b), the clitic immediately follows the fronted *VP*. If we assume that the fronted *VP* is parsed as a separate I-phrase, then the deviance of (19b) is explained. Assuming this, let us see how fronted *VP*s behave with respect to the generalization in (16), repeated below.

- (16) Intonational Phrase Edge Generalization (IPEG)
 The edge of an I-phrase cannot be empty
 (where the notion edge encompasses the specifier and head of the relevant syntactic constituent)

First, the following data shows that multiple *VP*-fronting is possible in English.¹¹

- (20) (?)_[*vP* Kill the dog] John did and [_{*vP*} kill the pig] Mary did
 (cf. John killed the dog and Mary killed the pig)

However, when gapping is applied to the fronted *vP* in the second conjunct, the sentence becomes degraded.

- (21) ?*_[*vP* Kill the dog] John did and [_{*vP*} Ø the pig] Mary did
 (cf. John killed the dog and Mary Ø the pig)

The deviance of (21) receives a natural explanation under the current account. Note that before the application of *VP*-fronting, the specifier of the *vP* must already be empty, under the usual assumption that subjects raise from the specifier of *vP*. In addition, recall further that fronted *VP*s are parsed as separate I-phrases. Then, it follows from the generalization in (16) that the head of the fronted *VP* must not be empty, which is borne out by the deviance of (21). The relevant configuration of (21) can be represented as follows:

- (22) * ... # [_{*vP*} Ø Ø the pig] # Mary did

Given this state of affairs, we may notice a parallelism between phases and I-phrases. Recall that both PIC and IPEG make use of the notion ‘edge’ (i.e., specifier and head) of the relevant constituent. We may assume that one of the characteristic properties of derivation is its edge-sensitivity, which takes different guises depending on the relevant components of the derivation: in the syntactic component, this edge-sensitivity takes the form of the locality condition PIC, while it takes the form of IPEG during the process of prosodic

mapping in PF. In other words, we can consider the PIC and IPEG to reflect the same general property of the grammar - namely, edge-sensitivity.

It is also worth noting here that it is likely that not all I-phrases can be regarded as phases¹², while it seems plausible that all phases can be I-phrases. I speculate that the notion of phase or its instantiation as the PIC may not be an irreducible property that is restricted to the narrow syntactic component, but is derivative of a more fundamental property having to do with the interface. This view is in line with the recent trend in syntactic literature where the locality effect of phases in the syntax is argued to follow from PF-related properties such as multiple spell-out and, crucially, linearization (Bošković 2005, Fox and Pesetsky, to appear; see also Uriagereka 1999, Chomsky 2000, 2001).

To summarize, in this section, I have addressed the nature of the notion of phase. More precisely, I have speculated that the fact that the PIC makes use of the periphery of a relevant syntactic constituent may reflect a more fundamental property of derivation having to do with the PF interface.

6. Conclusion

In this paper, I discussed the distribution of null C clauses in English. It is argued that the process of prosodic mapping between syntax and phonology, especially, assignment of I-phrases, is crucially involved in determining the distribution of null C clauses. It was argued that the deviance of null C clauses in certain syntactic positions is essentially a result of a mismatch between the relevant prosodic units. It was also suggested that there is a parallelism between the PIC and IPEG, which I assume to reflect a fundamental property of the derivation, namely, edge-sensitivity.

Notes

* Special thanks are due to Željko Bošković for many hours of discussion and comments. I also thank Jonathan Bobaljik, Karen O'Brien, William Snyder, and the audience at WECOL 2004 (USC) for helpful comments. All remaining errors are mine.

¹ Throughout, due to limitations on space, I will only present simple cases and avoid presenting more complicated cases. I refer the reader to my work in progress for further details and discussion.

² For detailed discussion and critique of these analyses, see my work in progress.

³ Here, I do not imply that a phrase must always have a specifier position. I am simply pointing out that the relevant CPs invariably lack an overt SpecCP, which I argue not to be an accident.

⁴ According to Selkirk (1984), an I-phrase can be characterized as a prosodic unit with respect to which the characteristic intonational contours of a language are defined. An I-phrase can also be characterized as a sequence of pitch accents, flanked by an (optional) boundary tone or pause (see also Bošković 2001, Nespor & Vogel 1986, Radanović-Kocić 1988, 1996, Schütze 1994)

⁵ As Željko Bošković (p.c.) pointed out to me, one potential interfering factor is that the example here includes a nonfinite clause, while our examples involve finite clauses. However, in the absence of evidence to the contrary, I assume that this difference is not relevant.

⁶ Bošković (2001) also notes that a pause has to follow the nominal head in (13), which is a typical sign of an I-phrase break.

⁷ Regarding the discussion in section 3.2, it is crucial that the assignment of an I-phrase to the relevant constituents is obligatory. Otherwise, we will lose the account based on the generalization in (10). In fact, it is well-known that elements in certain syntactic positions are obligatorily parsed as separate I-phrases. These positions include (but are not limited to) root clauses, parenthetical expressions, nonrestrictive relative clauses, tag questions, vocatives, and certain moved elements (Bošković 2001, Nespors and Vogel 1986, Schütze 1994, Selkirk 1978, 1984, 1986).

⁸ It is often proposed in the literature that there is a level of phonological phrase between the level of I-phrase and that of prosodic words. However, whether the level of phonological phrases in English exists is somewhat controversial. Here, I adopt Selkirk's (1984) view that the level of phonological phrases is not motivated in English, and assume that the next level below the level of I-phrases is the level of prosodic words.

In addition, I assume that prosodic words can be informally defined as phonologically independent words that bear stress (Schütze 1994). If so, prosodic words cannot be built on phonologically null elements.

⁹ Note that the boundary of a prosodic word is not necessarily required to coincide with that of an I-phrase, while the boundary of an I-phrase must coincide with that of a prosodic word.

¹⁰ A clarification is necessary. I use 'VP-fronting' as a cover term, which refers to an operation by which a phrase that is projected from a verb, be it *vP* or *VP*, is moved. The reason for using this is because there can be an issue regarding whether *VP*-fronting moves *vP* or *VP*.

There are two related issues: first, Abels (2003) argues that what is moved by *VP*-fronting (in transitive clauses) is in fact the whole *vP*, not *VP*. Second, there is an issue regarding passive and unaccusative sentences, which are usually assumed to lack *vP*. However, Legate (2003) argues that the *VPs* in these constructions are also phrases.

¹¹ There seems to be some variation regarding multiple *VP*-fronting in English. Some speakers find such constructions marginal. However, to some speakers, such constructions are acceptable, if given an appropriate context. For example, William Snyder (p.c.) pointed out to me that (20) is fully acceptable in a situation like the following.

- (i) To survive the winter, John would have to kill the dog and Mary would have to kill the pig.
Well, kill the dog John did and kill the pig Mary did.

¹² See note 7 above for different types of I-phrases.

References

- Abels, Klaus. 2003. *Successive Cyclicity, Anti-Locality, and Adposition Stranding*. Ph.D. dissertation, University of Connecticut, Storrs.
- An, Duk-Ho. to appear. Clauses in noncanonical positions in PF. *Syntax*.
- Bošković, Željko. 1997. *The Syntax of Nonfinite Complementation: An Economy Approach*. Cambridge, Mass.: MIT Press.
- Bošković, Željko. 2001. *On the Nature of the Syntax-Phonology Interface: Cliticization and Related Phenomena*. Amsterdam: Elsevier.
- Bošković, Željko. 2005. On the locality of Move and Agree: Eliminating the Activation Condition, Generalized EPP, Inverse Case Filter, and Phase-Impenetrability Condition. Simona Herdan and Miguel Rodríguez-Mondoñedo (eds). University of Connecticut Occasional Papers in Linguistics 3. Department of Linguistics, University of Connecticut, Storrs.
- Bošković, Željko, and Howard Lasnik. 2003. 'On the distribution of null complementizers', *Linguistic Inquiry*, **34**: 527-546.
- Bresnan, Joan. 1972. *Theory of complementation*. Ph.D. dissertation. MIT, Cambridge, Mass.

- Browne, Wayles. 1974. 'On the problem of enclitic placement in Serbo-Croatian', *Slavic Transformational Syntax, Michigan Slavic Materials* 10, ed. by Richard D. Brecht and Catherine V. Chvany, 36-52. Ann Arbor: Department of Slavic Languages and Literatures, University of Michigan.
- Ćavar, Damir, and Chris Wilder. 1993. Verbal and pronominal clitics in Croatian. Paper presented at the Geneva Workshop on the Wackernagel Position.
- Chen, Matthew. 1990. 'What must phonology know about syntax?', *The Phonology-Syntax Connection*, ed. by Sharon Inkelas and Draga Zec, 19-46. Chicago: The University of Chicago Press.
- Chomsky, Noam. 1995. *The Minimalist Program*. Cambridge, Mass.: MIT Press.
- Chomsky, Noam. 2000. 'Minimalist inquiries', *Step by Step: Essays on Minimalist Syntax in Honor of Howard Lasnik*, ed. by Roger Martin, David Michaels, and Juan Uriagereka, 53-87. Cambridge, Mass.: MIT Press.
- Chomsky, Noam. 2001. 'Derivation by phase', *Ken Hale: A Life in Language*, ed. by Michael Kenstowicz, 1-52. Cambridge, Mass.: MIT Press.
- Doherty, Cathal. 1997. 'Clauses without complementizers: Finite IP-complementation in English', *The Linguistic Review*, 14:197-220.
- Fox, Danny and David Pesetsky. to appear. 'Cyclic linearization of syntactic structure', In *Theoretical Linguistics: Special Issue on Object Shift in Scandinavian*, ed. by Katalin É. Kiss.
- Grimshaw, Jane. 1979. 'Complement selection and the lexicon', *Linguistic Inquiry*, 10: 279-326.
- Grimshaw, Jane. 1997. 'Projection, heads, and optimality', *Linguistic Inquiry*, 28:373-422.
- Guimarães, Maximiliano. 1998. PF reflexes of phase boundaries. Contribution to Minimalist Issues Chat Room, University of Maryland.
- Hale, Ken, and Elisabeth Selkirk. 1987. 'Government and tonal phrasing in Papago', *Phonology Yearbook*, 4: 151-183.
- Halpern, Aaron L. 1992. *Topics in the Placement and Morphology of Clitics*. Ph.D. dissertation. Stanford University.
- Huang, C.-T. James. 1993. 'Reconstruction and the structure of VP: some theoretical consequences', *Linguistic Inquiry*, 24:103-138.
- Legate, Julie Anne. 2003. 'Some interface properties of the phase', *Linguistic Inquiry*, 34: 506-516.
- Nespor, Marina, and Irene Vogel. 1986. *Prosodic Phonology*. Dordrecht: Foris.
- Ormazabal, Javier. 1995. *The Syntax of Complementation: on the Connection between Syntactic Structure and Selection*. Ph.D. dissertation. University of Connecticut, Storrs.
- Pesetsky, David. 1992. Zero syntax, vol. 2. Ms., MIT, Cambridge, Mass.
- Pesetsky, David, and Esther Torrego. 2001. 'T-to-C movement: causes and consequences', *Ken Hale: A Life in Language*, ed. by Michael Kenstowicz, 355-426. Cambridge, Mass.: MIT Press.
- Progovac, Ljiljana. 1996. 'Clitics in Serbian/Croatian: Comp as the second position', *Approaching Second: Second Position Clitics and Related Phenomena*, ed. by A. Halpern and A. Zwicky, 411-428. CSLI, Stanford.
- Radanović-Kocić, Vesna. 1988. *The Grammar of Serbo-Croatian clitics: A Synchronic and Diachronic Perspective*. Ph.D. dissertation. University of Illinois, Urbana-Champaign.

- Radanović-Kocić, Vesna. 1996. 'Placement of Serbo-Croatian clitics: A prosodic approach', *Approaching Second: Second Position Clitics and Related Phenomena*, ed. by A. Halpern and A. Zwicky, 429-445. CSLI, Stanford.
- Richards, Norvin. 1999. 'Complementizer cliticization in Tagalog and English', *Proceedings of The Sixth Meeting of the Austronesian Formal Linguistics Association (AFLA)*. Toronto Working Papers in Linguistics 16, ed. by Carolyn Smallwood and Catherine Kitto, Toronto: Department of Linguistics, University of Toronto.
- Schütze, Carson. 1994. 'Serbo-Croatian Second Position Clitic Placement and the Phonology-Syntax Interface', *Papers on Phonology and Morphology: MIT Working Papers in Linguistics* 21, ed. by A. Carnie, H. Harley, and T. Bures, 373-473. Cambridge, Mass.: MITWPL, Dept. of Linguistics and Philosophy, MIT.
- Selkirk, Elisabeth. 1978. On prosodic structure and its relation to syntactic structure. Paper presented at the Conference on Mental Representation in Phonology. [Reprinted by the Indiana University Linguistics Club, 1980]
- Selkirk, Elisabeth. 1984. *Phonology and Syntax: The Relation between Sound and Structure*. Cambridge, Mass.: MIT Press.
- Selkirk, Elisabeth. 1986. 'On derived domains in sentence phonology', *Phonology Yearbook*, 3: 371-405.
- Snyder, William, and Susan Rothstein. 1992. 'A note on contraction, case and complementizers', *The Linguistic Review*, 9: 251-266.
- Stjepanović, Sandra. 1999. *What do Second Position Cliticization, Scrambling, and Multiple Wh-fronting have in Common?* Ph.D. dissertation. University of Connecticut, Storrs.
- Stowell, Tim. 1981. *Origins of Phrase Structure*. Ph.D. dissertation. MIT, Cambridge, Mass.
- Truckenbrodt, Hubert. 1999. 'Syntactic phrases and phonological phrases', *Linguistic Inquiry*, 30: 219-255.
- Uriagereka, Juan. 1999. 'Multiple spell-out', In *Working Minimalism*, ed. S. D. Epstein & N. Hornstein, 251-282. Cambridge, Mass.: MIT Press.
- Webelhuth, Gert. 1989. *Syntactic Saturation Phenomena and the Modern Germanic Languages*. Ph.D. dissertation. University of Massachusetts, Amherst.
- Wilder, Chris, and Damir Čavar. 1994. 'Long head movement? Verb movement and cliticization in Croatian', *Lingua*, 93: 1-58.
- Zec, Draga, and Sharon Inkelas. 1990. 'Prosodically constrained syntax', *Phonology-Syntax Connection*, ed. by Sharon Inkelas and Draga Zec, 365-378. Chicago: University of Chicago Press.

Duk-Ho An
 University of Connecticut
 Department of Linguistics,
 University of Connecticut,
 337 Mansfield Rd, U-1145,
 Storrs, CT 06269
 duk-ho.an@uconn.edu

Partial Identity Avoidance as Cooperative Interaction

Eric Baković
UCSD

1. Introduction

Consider the English past tense morpheme, with alternants [t], [d], and [əd]. The syllabic alternant [əd] is suffixed to verb stems ending in /t/ or /d/, consonants that are identical to the consonant of the past tense morpheme except that any difference in the value of a specific feature, voicing, is ignored. Borowsky (1986, 1987) identifies this example as a case of *antigemination*, McCarthy's (1986) term for a class of cases in which a regular vowel syncope process is blocked just in case the result would be a sequence of adjacent identical consonants — or, as in English, adjacent consonants that are identical enough.

Whether two adjacent consonants are identical enough must be determined by comparing certain features and ignoring certain others, a distinction that must apparently be stipulated for each feature. What it means for two adjacent consonants to be “basically the same type” (Langacker 1968:169-170) was thus correctly judged to be “an embarrassment to current theory” by Harms (1978:50). The representational advances of subsequent research in phonological theory did little to lessen this embarrassment; to date, there is still no principled explanation for the fact that voicing and only voicing can be ignored in the determination of adjacent consonant identity in English, leading to the selection of the syllabic alternant [əd] of the past tense morpheme after verb stems ending in the sufficiently identical consonants /t/ and /d/. But note that voicing is exactly the feature that governs the assimilatory distribution of the nonsyllabic alternants of the same morpheme: [t] is suffixed to verb stems ending in voiceless consonants *except* /t/, whereas [d] is suffixed to verb stems ending in voiced consonants *except* /d/. If not for the syllabic alternant, then, the result of suffixing one of these nonsyllabic alternants to a stem ending in /t/ or /d/ would be a sequence of *completely identical* adjacent consonants [tt] or [dd] due to the independently expected application of voicing assimilation word-finally in English. The distribution of [əd] should thus follow from some sort of *cooperation* between the avoidance of sequences that disagree in voicing word-finally and the avoidance of completely (i.e., not simply ‘sufficiently’) identical adjacent consonants.

I propose in this paper that the avoidance of sufficiently identical adjacent consonants is always the result of cooperative interactions of the kind just suggested, and that constraint interaction as defined in Optimality Theory (Prince & Smolensky 1993/2004, henceforth OT) is the necessary tool for expressing cooperative interaction. At the heart of the proposal is Rose's (2000) NO-GEM constraint, which strictly penalizes geminates. There is no need for a weaker version of this constraint to penalize adjacent consonants that share all but a specific, stipulated subset of features; this work is taken up by other active constraints in the grammar that independently penalize the relevant similar-but-not-identical alternatives. In the case of English, for example, the markedness constraint responsible for word-final voicing assimilation independently rules out the crucial [td] sequence. These constraints cooperate to enforce the avoidance of sufficiently identical adjacent consonants; violations of them are collectively circumvented by violating some crucially lower-ranked constraint(s).

The crux of this proposal is the necessary dependence of the analysis on independent aspects of the grammar of the language in question. In situations where NO-GEM is not at stake, the prediction is that candidates that violate the cooperating constraint(s) are necessarily suboptimal. By crucially invoking other active constraints in the grammar in this way, a cooperative interaction analysis makes predictions and captures generalizations that an alternative analysis with an *ad hoc* constraint against sufficiently identical adjacent consonants in principle cannot. The proposal is thus further corroborated by the extent to which cooperating constraint(s) are active in the grammar of the language in question.

There is also a simple Occam's Razor argument against accounting for sufficient identity avoidance directly with constraints penalizing adjacent consonants that are identical enough. NO-GEM is independently motivated to account not only for the observed crosslinguistic markedness of geminate consonants, but also for more strict examples of antigemination involving the avoidance of completely identical adjacent consonants alone. Additional constraints specifically penalizing sufficiently identical adjacent consonants are rendered unnecessary to the extent that the cooperative interaction between NO-GEM and other active constraints is itself sufficient to account for sufficient identity avoidance.

2. English

The past tense and plural suffixes in English are standard introductory textbook examples of morphophonemic alternation (Hockett 1958, Langacker 1968, Fromkin 2000, among others). The research literature is also riddled with references to these alternations, with particular attention paid to them in such works as Bloch (1947), Luelsdorff (1969), Hoard & Sloat (1971), Basbøll (1972), Anderson (1973), Harms (1978), Kiparsky (1985), Borowsky (1986, 1987), Pinker & Prince (1988), and Benus et al. (2004).

The avoidance of sufficiently identical adjacent consonants apparent in these alternations is a model case for the present proposal: NO-GEM crucially interacts with other constraints independently motivated by the very same set of alterna-

tions. The resulting analysis illustrates in particularly clear terms the most important result of the proposal: in order to accomplish the work of a putative constraint that simply stipulates what it means for adjacent consonants to be sufficiently identical, NO-GEM must interact cooperatively with other constraints the activity of which is independently demonstrable.

2.1 Past tense suffix alternations

The past tense form of a verb in English is regularly formed by suffixation of one of three phonologically-conditioned alternants: a voiceless alternant [t], suffixed to stems ending in [-voi] obstruents other than /t/; a voiced alternant [d], suffixed to stems ending in [+voi] segments other than /d/, and a syllabic-and-voiced alternant [əd], suffixed to stems ending in /t/ or /d/.¹

Straightforward and uncontroversial arguments demonstrating that the underlying representation of the past tense suffix must be /d/ as opposed to /t/ or /əd/ are presented in Fromkin (2000:609ff), Pinker & Prince (1988:101ff), and Benus et al. (2004). I accept these arguments and proceed under this assumption, but the basic point of the analysis is not substantively affected by this choice.

The voiceless alternant [t] is found after voiceless consonants, but the assimilation responsible for this fact does not apply following /t/. It would be possible to exclude /t/ from the set of voiceless consonants relevant to assimilation, but this would fail to explain why exactly this consonant is excluded — the one consonant that differs from the past tense morpheme only in terms of the feature [±voi]. Similarly, it would be possible to exclude [±voi] from the set of features relevant to the epenthesis process responsible for the distribution of the syllabic alternant [əd]; again, this would fail to explain why exactly this feature is excluded — the one feature that, if allowed to assimilate as otherwise expected in /t+d/, would yield a sequence of completely identical adjacent consonants.

Another way to look at the situation is as follows. Voicing assimilation unexpectedly fails to apply in the context /t+d/, and epenthesis unexpectedly goes out of its way to apply in exactly this context. Precisely where one process loses ground, the other process gains it; these processes are clearly interacting with each other in some crucial way. Previous accounts appeal to extrinsic rule ordering: epenthesis precedes and bleeds voicing assimilation, accounting for the exceptionality of /t/ to the latter.² The problem, of course, is that this approach still fails to explain the exceptionality of [±voi] to epenthesis.

Output candidate comparison and constraint interaction as defined in OT are perfectly suited to this kind of problem. Epenthesis applies to /t+d/ because the alternatives to the optimal epenthetic candidate [təd] — voice-assimilated *[tt] and faithful *[td] — are independently penalized by active constraints in the grammar. One of these constraints is NO-GEM, ruling out the assimilated candidate *[tt]. The other is the independently active markedness constraint responsible for voicing assimilation — here called SEQ(voi) — ruling out the faithful candidate *[td]. These two constraints thus cooperate to ensure the optimality of epenthetic [təd], which violates the lower-ranked faithfulness constraint DEP-V.

SEQ(voi) penalizes tautosyllabic obstruents that disagree in $[\pm\text{voi}]$. Note that both the ‘tautosyllabic obstruents restriction is necessary in the structural description of this constraint; sequences of obstruents that disagree in $[\pm\text{voi}]$ across syllables are common in English (*subcase* [bk], *backbone* [kb], *baseball* [sb]), as are tautosyllabic sequences of $[\text{+voi}]$ sonorants and $[\text{-voi}]$ obstruents (*apron* [pr], *apply* [pl], *snow* [sn], *part* [rt], *pint* [nt], *fault* [lt]).³ In order to enforce voicing assimilation, SEQ(voi) must dominate the faithfulness constraint IDENT(voi) penalizing changes in $[\pm\text{voi}]$ from input to output. But SEQ(voi) can in principle be satisfied by changes other than assimilation; for instance, it can be satisfied by epenthesis. DEP-V must thus also dominate IDENT(voi).

The following tableaux demonstrate how the ranking just established works with relevant examples. (The comparative tableau format (Prince 2002) is used to clarify necessary rankings.) The first tableau below shows how the ranking works with a stem ending in a $[\text{-voi}]$ consonant other than /t/. The optimal assimilated candidate is compared with the suboptimal faithful candidate in (i). The assimilated candidate is preferred by SEQ(voi), while the faithful candidate is preferred by lower-ranked IDENT(voi). This justifies the ranking SEQ(voi) » IDENT(voi). In (ii), the optimal assimilated candidate is compared with the epenthetic candidate, which manages to satisfy SEQ(voi) as well as the optimal assimilated candidate does while performing better on IDENT(voi). The fact that the assimilated candidate is optimal justifies the ranking DEP-V » IDENT(voi).

- (1) English past tense after e.g. voiceless bilabial stop: *tapped* [pt]

/p+d/ → [pt]	NO-GEM	SEQ(voi)	DEP-V	IDENT(voi)
i. [pt] ~ [pd]		W		L
ii. [pt] ~ [pəd]			W	L

Note that no ranking of the constraints is necessary with a stem ending in a $[\text{+voi}]$ segment other than /d/, as shown in the next tableau. Both relevant alternatives to the optimal faithful candidate — the suboptimal epenthetic candidate in (i) and the suboptimal devoiced candidate in (ii) — fare worse on one or more of the constraints. The optimal faithful candidate satisfies them all.

- (2) English past tense after e.g. voiced bilabial stop: *tabbed* [bd]

/b+d/ → [bd]	NO-GEM	SEQ(voi)	DEP-V	IDENT(voi)
i. [bd] ~ [bəd]			W	
ii. [bd] ~ [bt]		W		W

The next tableau demonstrates how the ranking works with a stem ending in /d/. Comparing the optimal epenthetic candidate with the faithful candidate in (i), the epenthetic candidate is preferred by undominated NO-GEM, while the faithful candidate is preferred by lower-ranked DEP-V. This justifies NO-GEM » DEP-V. In (ii), the optimal devoiced candidate is compared with a supoptimal candidate which manages to satisfy NO-GEM as well as the optimal candidate does while performing better on DEP-V. The fact that the epenthetic candidate is

optimal justifies the ranking $\text{SEQ}(\text{voi}) \gg \text{DEP-V}$. (It can't be $\text{IDENT}(\text{voi}) \gg \text{DEP-V}$, because the opposite ranking was already established in (1).)

(3) English past tense after voiced coronal stop: *ceded* [dəd]

/d+d/ → [dəd]	NO-GEM	SEQ(voi)	DEP-V	IDENT(voi)
i. [dəd] ~ [dd]	W		L	
ii. [dəd] ~ [dt]		W	L	W

This final ranking of $\text{SEQ}(\text{voi})$ above DEP-V is also necessary to account for the fate of the input /t+d/. The optimal epenthetic candidate [təd] fares worse than its competitors on DEP-V , but the faithful candidate *[td] and the assimilated candidate *[tt] violate higher-ranked $\text{SEQ}(\text{voi})$ and NO-GEM , respectively.

(4) Epenthesis, not voicing assimilation: *seated* [təd]

/t+d/ → [təd]	NO-GEM	SEQ(voi)	DEP-V	IDENT(voi)
i. [təd] ~ [td]		W	L	
ii. [təd] ~ [tt]	W		L	W

The key here is the way in which the dominant markedness constraints NO-GEM and $\text{SEQ}(\text{voi})$ work together — how they interact cooperatively — to enforce epenthesis. The ranking of $\text{SEQ}(\text{voi})$ and DEP-V above $\text{IDENT}(\text{voi})$ prefers devoicing after stems ending in voiceless segments, but in the case of /t+d/ the result of devoicing would be *[tt], which is blocked by NO-GEM . The ranking of NO-GEM and DEP-V above $\text{IDENT}(\text{voi})$ also establishes a preference for devoicing in the case of /d+d/; however, the result in this case would be *[dt], which is blocked by $\text{SEQ}(\text{voi})$. Epenthesis is the next best option in both cases, violating the higher-ranked of the two faithfulness constraints DEP-V but satisfying both of the even higher-ranked markedness constraints NO-GEM and $\text{SEQ}(\text{voi})$.

2.2 Plural suffix alternations

The plural suffix in English exhibits a pattern of alternations that is very similar to that of the past tense suffix.⁴ The similarities between the alternants of this suffix and those of the past tense are fairly obvious: there is a voiceless alternant [s], suffixed after stems ending in [-voi] obstruents other than /s, ʃ, tʃ/; a voiced alternant [z], suffixed after stems ending in [+voi] segments other than /z, ʒ, dʒ/; and a syllabic-and-voiced alternant [əz], suffixed after stems ending in /s, ʃ, tʃ, z, ʒ, dʒ/.⁵ For the sake of concreteness — and as with the past tense suffix, not crucially or controversially — I assume that the alternants of this morpheme arise from the underlying representation /z/.

The key difference between the plural and past tense suffixes lies in the distribution of their syllabic alternants. If the syllabic alternant of the plural suffix only followed consonants that differ at most in [$\pm\text{voi}$] from the consonant of the suffix, it would only be suffixed to stems ending in /s/ and /z/. However, we find the syllabic alternant of this suffix also following /ʃ/, /ʒ/, /tʃ/, and /dʒ/ — that is, following all of the sibilants of English. It seems that at least one other feature must be ignored in the determination of adjacent consonant identity.

Traditionally, the feature [\pm anterior] distinguishes [+ant] /s, z/ from [-ant] /ʃ, ʒ, tʃ, dʒ/, following the typical phonetic classification of the former as alveolar and the latter as postalveolar. As noted in Gafos (1997) and references therein, however, the exact point of the articulator to make contact (tongue tip or blade) and the exact point of contact of the articulator on the palate (dental, alveolar, or postalveolar) varies more widely from speaker to speaker than is suggested by these classifications. Gafos shows that the phonetic distinction holding constant across this variation is a measurable relative difference in “the cross-sectional area of the channel between the tongue and the palate” (Gafos 1997:130).

Based on this and other evidence, Gafos proposes “a distinctive feature, called Cross-Sectional Channel (CSC), defined on the phonetic scale of the area of the fricative channel which is created by the approximation of the tip-blade to the palate” (Gafos 1997:128). The CSC value for /s, z/ is [narrow] and the CSC value for /ʃ, ʒ, tʃ, dʒ/ is [mid].⁶ Different speakers are free to implement this contrast in different ways, as is observed; some speakers (such as myself) may have a lamino-dental articulation for /s, z/ and an alveolar articulation for /ʃ, ʒ, tʃ, dʒ/, while other speakers may have an apico-alveolar articulation for /s, z/ and a postalveolar articulation for /ʃ, ʒ, tʃ, dʒ/ — the articulatory difference that is often assumed, explicitly or implicitly, in typical descriptions of this contrast.

I follow Sagey (1986) in assuming that the affricates /tʃ, dʒ/ are internally complex segments, with a [-cont] gesture followed by a [+cont] gesture on the same tier (*cf.* Lombardi (1990)). The necessary specifications of the four [-voi]~[+voi] pairs of coronal affricates and fricatives are thus as shown in (5) below. The CSC value is assumed here to be part of the specification of the coronal articulator, and [\pm cont] is assumed to be a dependent of this articulator (Padgett 1994, 1995). Variations in featural dependency that are consistent with the specifications in (5) should be compatible with what follows.

(5) Coronal fricative distinctions

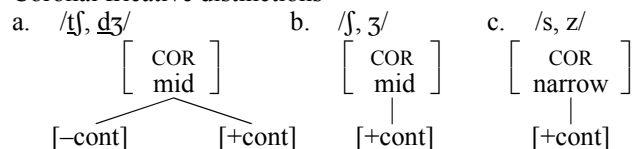

The representation of the affricates /tʃ, dʒ/ in (5)a clarifies what is meant to be conveyed by the underlining in their transcription: both halves of these segments are specified with the CSC value [mid] and thus involve the same subcoronal articulation. Although /t, d/ do not contrast with other stops in terms of their CSC value in English, their precise subcoronal articulation typically differs from the subcoronal articulation of the initial [-cont] portion of /tʃ, dʒ/. For example, my own articulation of the stops /t, d/ is more apico-laminal compared to my strictly apical articulation of (both halves of) the affricates /tʃ, dʒ/. Following Borowsky (1987:675), I assume that the order between the [\pm cont] specifications of an affricate means that NO-GEM is violated by a stop to the left of, or a fricative to the right of, an otherwise identically-specified affricate. Thus, an

affricate /dʒ/ differs from a following fricative /z/ only in its CSC value but from a following stop /d/ in [\pm cont] as well, which is why epenthesis is required when the plural, but not the past tense, is suffixed to an affricate-final stem.

The CSC contrasts in (5) remain to be factored into the analysis developed so far. Standard accounts of the plural suffix alternation, having already fallen into the trap that ignorance of [\pm voi] in the calculation of adjacent segment identity is a coincidence, cope with the further ignorance of CSC values (however these are assumed to be featurally represented) as if this were just another coincidence. For example, Fromkin (2000:625) suggests “a modified definition of the notion *similar consonants*” (emphasis in the original): a stipulation that neither [\pm voi] nor CSC differences matter to the applicability of epenthesis. I have shown that this stipulation is unnecessary in the case of [\pm voi], and I now show that it is also unnecessary in the case of the CSC value contrasts among English coronals.

The key to the analysis is the constraint SEQ(COR) in (6), penalizing adjacent segments differing in their subcoronal articulatory specifications: tip vs. blade, which I refer to as the *point of articulation*, and alveolar vs. postalveolar, which I refer to as the *place of articulation*. Because the contrast between CSC [mid] /ʃ, ʒ, ʒ/, dʒ/ and CSC [narrow] /s, z/ is implemented as some distinction in subcoronal articulation, adjacent [mid] and [narrow] violates this constraint.

(6) SEQ(COR) = *[υ] [ϖ], where $\upsilon \neq \varpi$ and $\upsilon, \varpi \in \langle \text{point-place specifications} \rangle$

The following tableau details how SEQ(COR) interacts cooperatively with NO-GEM and SEQ(voi) to produce the correct result with an input of the form /ʃ+z/; that is, a form with a stem-final sibilant that differs in terms of both [\pm voi] and CSC value from the plural suffix. So long as all three of the markedness constraints are ranked above DEP-V, epenthesis is correctly predicted to be optimal: not assimilating at all (i) fares worse than epenthesis on both SEQ(COR) and SEQ(voi), voicing assimilation alone (ii) fares worse than epenthesis on SEQ(COR), CSC assimilation alone (iii) fares worse than epenthesis on SEQ(voi), and complete assimilation (iv) fares worse than epenthesis on NO-GEM.

(7) Epenthesis: *bushes* [ʃəz]

/ʃ+z/ → [ʃəz]	NO-GEM	SEQ(voi)	SEQ(COR)	DEP-V
i. [ʃəz] ~ [ʃz]		W	W	L
ii. [ʃəz] ~ [ʃs]			W	L
iii. [ʃəz] ~ [ʃʒ]		W		L
iv. [ʃəz] ~ [ʃʃ]	W			L

Bringing SEQ(COR) into the analysis has further consequences. Because SEQ(COR) must dominate DEP-V in order to obtain the correct result in (7), the prediction made is that — all things being equal — violation of SEQ(COR) can always be avoided because violation of DEP-V is at least better, if not best.

It can be easily verified that DEP-V violation is not the best way to avoid SEQ(COR) violation; in minimally different contexts, SEQ(COR) does not enforce epenthesis. Consider, for example, the regular past tense forms such as *cached*

/ʃ+d/, *matched* /tʃ+d/, and *judged* /dʒ+d/. None of these forms undergoes epenthesis, yet violation of DEP-V should be more harmonic than violation of SEQ(COR).⁷ But do these consonant sequences in fact violate SEQ(COR)? Results from a static palatography study discussed by Baković & Kilpatrick (2005) show that the past tense suffix indeed shares the subcoronal articulation determined by the CSC value of the preceding sibilant. SEQ(COR) is correctly predicted to be independently active in English, but it is satisfied by CSC assimilation rather than by epenthesis in contexts where NO-GEM is not at stake. This is because DEP-V dominates IDENT(CSC), defined in (8).

(8) IDENT(CSC) = * $[v]_i \rightarrow [\varpi]_o$, where $v \neq \varpi$ and $v, \varpi \in \{[\text{narrow}], [\text{mid}]\}$

The following comparative tableau adds this constraint and ranking to the analysis developed so far. The input considered here is /ʃ+d/; that is, a stem-final sibilant that differs in terms of both $[\pm\text{voi}]$ and CSC from the past tense suffix. Since the two consonants also differ in terms of $[\pm\text{cont}]$, NO-GEM is not at stake and so the candidate with both CSC and voicing assimilation is optimal. As with the initial $[-\text{cont}]$ half of the affricates /tʃ, dʒ/, I henceforth use underlining to transcribe the result of assimilation of the stop of the past tense suffix with a preceding CSC [mid] sibilant; e.g., the optimal form [ʃt̩] in (9).

(9) CSC and voicing assimilation of the past tense suffix

/ʃ+d/ → [ʃt̩]	SEQ(voi)	SEQ(COR)	DEP-V	ID(voi)	ID(CSC)
i. [ʃt̩] ~ [ʃd]	W	W		L	L
ii. [ʃt̩] ~ [ʃt]		W			L
iii. [ʃt̩] ~ [ʃd̩]	W			L	
iv. [ʃt̩] ~ [ʃəd]			W	L	L

SEQ(voi) and SEQ(COR) again do their part in ruling out the completely unasimilated candidate (i), the CSC-unassimilated candidate (ii), and the $[\pm\text{voi}]$ -unassimilated candidate (iii). The competition boils down to (iv), between the optimal candidate with both CSC and voicing assimilation and the suboptimal epenthetic candidate. The assimilated candidate fares worse on both IDENT(voi) and IDENT(CSC), but of course it fares better than the epenthetic candidate on the higher-ranked constraint DEP-V.

Differences in CSC values (and their implementations as different subcoronal articulations) thus play a perfectly parallel role to differences in voicing values in the proposed analysis. The calculation of adjacent segment identity appears to ignore both voicing and CSC value differences because such differences are independently prohibited, whether or not the segments are otherwise identical. Both of these prohibitions are regularly resolved via assimilation when the adjacent segments are not otherwise identical; NO-GEM is irrelevant in such cases, making violation of DEP-V unnecessary.

CSC assimilation in English is also apparent in a set of examples originally discussed by Clements (1985), Sagey (1986), Borowsky (1986), and Yip (1988).

Sequences of coronal consonants in English assimilate in terms of their subcoronal articulation in several other contexts; in particular, /t, d, n/ surface with the same subcoronal articulation as a following CSC [mid] segment.

(10) *white shoes* [tʃ], *red shoes* [dʃ], *inch* [ntʃ], *hinge* [ndʒ], *insure* [nʃ]

Other examples include /t, d, n/-final stems with the suffix *-ship*: *courtship* [tʃ], *assistantship* [ntʃ], *headship* [dʃ], *friendship* [ndʃ], *relationship* [nʃ]. In these examples and those in (10), CSC assimilation is regressive, unlike the progressive assimilation found with the past tense suffix. There are also other examples of progressive CSC assimilation; note the contrast word-initially between *stoop* [st] and *schtup* [ʃt], and word-medially between *Austin* [st] and *Ash-ton* [ʃt], *answer* [ns] and *mansion* [nʃ]. The generalization appears to be that a stop assimilates bidirectionally to an adjacent fricative, which can be seen most clearly between members of a compound (*office tower* [st], *dish towel* [ʃt], *rebate center* [ts], *heat shield* [tʃ]) and between words within phrases (*kiss today* [st], *fish today* [ʃt], *hit someone* [ts], *hit Shiela* [tʃ]). Assimilation between otherwise contrastive sibilants is blocked when the first has the CSC value [mid], both in compounds (*fish soup* [ʃs]) and between words (*fish someday* [ʃs]); when the order of sibilants is reversed, assimilation is partial and gradiently affected by speech rate (*police sheriff*, *miss Sheila* (Zue & Shattuck-Hufnagel 1979).⁸ The lack of complete assimilation is plausibly due to the intervention of NO-GEM, but the question remains why the SEQ(COR) violation is tolerated when DEP-V violation (epenthesis) is preferable, given the ranking established in (7).

Note that it won't work to limit the applicability of SEQ(COR) to, e.g., tautosyllabic or word-final consonants. This will incorrectly exclude the cases cited above in which CSC assimilation does in fact apply in other contexts between sibilants and nonsibilants, for which there is no question of NO-GEM violation. Another approach would be to split DEP-V into two constraints, one penalizing epenthesis generally and a positionally-restricted variant penalizing epenthesis at word boundaries (DEP-V/#). The restriction to word boundaries is meant to allow epenthesis between stems and the past tense and plural suffixes but to exclude it between members of compounds and phrases and also between stems and prefixes or word-like suffixes like *-ship* (see footnote 8), a division which is consistent with the evidence for boundary distinctions in the lexical phonology and morphology of English (Siegel 1974, Kiparsky 1982, Borowsky 1986, 1993). The correct result is achieved if DEP-V/# and NO-GEM » SEQ(COR).

(11) Blocking of CSC assimilation and epenthesis: *fish soup* [ʃs]

/ʃ#s/ → [ʃs]	DEP-V/#	NO-GEM	SEQ(COR)	DEP-V
i. [ʃs] ~ [ʃʃ]		W	L	
ii. [ʃs] ~ [ʃəʃ]	W		L	W

Note that sequences violating NO-GEM do occur “across certain morpheme boundaries” (*superrich*, *dissatisfied*, *unnecessary*, *vowellike*, *subbranch*; From-

kin (2000:625)). These violations all occur between stems and prefixes or word-like suffixes; epenthesis is blocked here if DEP-V/# » NO-GEM.

(12) Blocking of epenthesis: *dissatisfied* [ss]

/s#s/ → [ss]	DEP-V/#	NO-GEM
[ss] ~ [səs]	W	L

Because NO-GEM dominates both SEQ(COR) and IDENT(CSC), however, violation of the latter two constraints should be preferable to violation of NO-GEM. In other words, we expect dissimilation: *dissatisfied* should surface with an [ʃs] sequence just like *fish soup*. There are two ways to resolve this issue, neither of which is problem-free. One is to limit the applicability of NO-GEM to word/syllable edges.⁹ However, a restricted NO-GEM cannot account for the lack of intramorphemic (and intervocalic) geminates in English, and cannot be recruited to account for the lack of assimilation and epenthesis in examples like *fish soup* (11). The other avenue is to focus on the problem of dissimilation with respect to NO-GEM satisfaction. Dissimilation is a common way to avoid sequences of individual features on otherwise distinct consonants, but it is less well attested as a way to avoid sequences of adjacent identical consonants.

The final rankings proposed to account for the English facts are as follows. To emphasize the main theme of the paper, I keep the core cooperative interaction ranking (13)a separate from the (completely compatible) ranking responsible for blocking of CSC assimilation and epenthesis (13)b.

(13) Final ranking for English

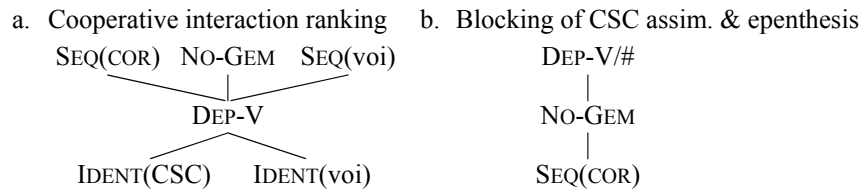

3. Summary and Conclusion

Avoidance of ‘sufficiently identical’ adjacent consonants is the result of a cooperative effort to satisfy more than one constraint. One of these is a constraint against completely identical adjacent consonants, NO-GEM, and the others are active constraints in the grammar that independently penalize the relevant candidates in which the adjacent consonants are not completely identical. These constraints interact cooperatively in order to be satisfied insofar as they do not crucially conflict with each other, the end result being that ‘sufficiently identical’ adjacent consonants are avoided. This proposal was applied in this paper to an analysis of the well-known past tense and plural suffix alternations in English. This analysis yielded two noteworthy results.

First, an important connection was established between the epenthesis and assimilation processes involved in these suffix alternations, explaining why each of them has different contexts of potential applicability and actual application. Epenthesis is potentially applicable between consonants that have identical values for all features but it actually also applies between consonants that disagree only in [\pm voi] or subcoronal point-place specifications. Crucially, these features are otherwise expected to assimilate in this context and to thereby create adjacent identical consonants. NO-GEM, SEQ(voi) and SEQ(COR) can all be satisfied only by epenthesis when the stem-final consonant is ‘sufficiently identical’ to the suffix consonant; more faithful candidates violate SEQ(voi) or SEQ(COR), and complete assimilation violates NO-GEM.

Second, a previously unnoticed assimilation was predicted and demonstrated to play a key role in these suffix alternations. The prediction arises because the plural suffix alternations indicate that both CSC [narrow] and CSC [mid] sibilants are ‘sufficiently identical’ to the CSC [narrow] plural suffix consonant to warrant epenthesis rather than voicing assimilation with sibilant-final stems. This requires an active constraint penalizing adjacent consonants that disagree in their subcoronal point-place specifications, SEQ(COR). Incorporating SEQ(COR) into the ranking requires that it dominate DEP-V, meaning that candidates with epenthesis will always be better than candidates violating SEQ(COR), all else being equal. Since there is no epenthesis with sibilant-final stems in the case of the past tense suffix, it must be that there is another SEQ(COR)-satisfying alternative, namely CSC assimilation.

At the outset of his paper on the morphology and morphophonemics of English verb inflection, Bloch (1947:399) cites a number of prominent earlier descriptions of the relevant facts and cautiously writes: “In view of the number and fullness of these descriptions, no new treatment can hope to add any facts hitherto overlooked: at most, a new treatment may be able to arrange the known facts more systematically than has been done before, or in a way that will be more useful to other linguists.” The novel prediction that the past tense suffix adopts the point-place specifications of a stem-final coronal, made necessary by the proposed analysis of the English plural suffix alternations, has shown that it is even more worthwhile than Bloch had thought to revisit “fully described” facts with new theoretical hypotheses.

Notes

¹ Schwa [ə] is used as a cover symbol for whatever the exact quality of the vocalic element of these suffixes is. I also gloss over flapping of /t/ and /d/ in some varieties of English. An identical suffix forms denominal adjectives (*hooked* [kt], *horned* [nd], *talented* [təd]; Pinker & Prince (1988:102)).

² Harms (1978:46) and Pinker & Prince (1988:106) go so far as to suggest that this ordering follows from phonology (epenthesis) preceding phonetics (voicing assimilation). Whether or not there is independent evidence for this modular division of labor in this case or otherwise, the constraints responsible for these processes are crucially intertwined in the analysis proposed below.

³ Cf. Harms (1978), Mester and Itô (1989), and Lombardi (1991, 1996), who assume that the relevant rule/constraint only targets final [-voi]-[+voi] sequences (and also initial [+voi]-[-voi] sequences, in the case of Harms’ “universal phonetic constraint” (1978:46)). In the present context, this narrower

interpretation of the constraint (as it applies finally) would predict that /d+d/ should be dealt with not by epenthesis but by devoicing, incorrectly resulting in *[dt].

⁴ Other suffixes that are identical to the plural include the 3rd person singular present tense, the possessive, reduced *has*, *is*, and *does*, and a few others; see Pinker & Prince (1988:102).

⁵ Note that the affricates /tʃ/ and /dʒ/ are transcribed with an underline diacritic to explicitly indicate that the initial [-cont] portions of these segments involve the same subcoronal articulation as the final [+cont] portions (see Ladefoged's (2001:145) transcriptions of these affricates in Quechua).

⁶ A third value, [wide], is for the remaining coronal fricatives /θ, ð/. The sibilants /s, z, ʃ, ʒ, tʃ, dʒ/ must differ from /θ, ð/ in some other feature (e.g., [±strident]) under any analysis in order to account for the lack of epenthesis upon plural suffixation to a /θ, ð/-final stem: *myths* [θs], *lathes* [ðz].

⁷ Thanks to Bob Kennedy and Colin Wilson for noting the relevance of these examples. Note that the same point being made here can be made for *ceased* /s+d/ and *seized* /z+d/, for speakers (like me) whose subcoronal articulation of /t, d/ also differs from that of /s, z/. I focus on the contrast between the subcoronal articulations of /t, d/ and /ʃ, ʒ, tʃ, dʒ/, if only because this is the contrast more often reinforced by standard classifications in terms of features like [±ant].

⁸ This latter fact was originally pointed out to me by Bruce Hayes (p.c.).

⁹ For Benus et al.'s (2004), what is crucially different about these cases is that the relevant sequence is intervocalic; independent constraints on gestural coordination conspire to block attempts to satisfy NO-GEM (in Benus et al. (2004), the gestural OCP) via open consonant-consonant transition.

References

- Anderson, Stephen. 1973. "Remarks on the Phonology of English Inflection." *Language and Literature*, 4, 33-52.
- Baković, Eric, and Cynthia Kilpatrick. 2005. "Anteriority assimilation in English." Ms. (in progress), UC San Diego. Presented at the First International Conference on the Linguistics of Contemporary English, Edinburgh, June 2005.
- Basbøll, Hans. 1972. "Remarks on the Regular Plural Formation of English Nouns." *Language and Literature*, 3, 39-42.
- Benus, Stefan, Iris Smorodinsky, and Adamantios Gafos. 2004. "Gestural coordination and the distribution of English 'geminate'." *Penn WPL*, 10.
- Bloch, Bernard. 1947. "English Verb Inflection." *Language*, 23, 399-418.
- Borowsky, Toni. 1986. *Topics in the Lexical Phonology of English*. PhD dissertation, University of Massachusetts, Amherst.
- Borowsky, Toni. 1987. "Antigemination in English Phonology." *LI*, 18, 671-678.
- Borowsky, Toni. 1993. On the word level. In *Studies in Lexical Phonology*, S. Hargus and E. Kaisse (eds.), 199-234. New York: Academic Press.
- Clements, George N. 1985. "The geometry of phonological features." *Phonology Yearbook*, 2, 225-252.
- Fromkin, Victoria A. (ed.). 2000. *Linguistics: An Introduction to Linguistic Theory*. Oxford: Blackwell.
- Gafos, Adamantios. 1997. "A Cross-Sectional View of [s], [sh], and [th]." *NELS* 27, 127-141. Amherst, MA: GLSA Publications.
- Harms, Robert. 1978. "Some Nonrules of English." In *Linguistic and literary studies in honor of Archibald A. Hill*, M. Ali Jazayery, E. C. Polomé and W. Winter (eds.), 39-51. Lisse: Mouton Publishers.
- Hoard, J. E., and C. Sloat. 1971. "The Inflectional Morphology of English." *Glossa*, 5, 47-56.
- Hockett, Charles F. 1958. *A Course in Modern Linguistics*. New York: Macmillan.

- Kiparsky, Paul. 1982. "Lexical phonology and morphology." In *Linguistics in the Morning Calm*, I. S. Yang (ed.), 3-91. Seoul: Hanshin.
- Kiparsky, Paul. 1985. "Some consequences of Lexical Phonology." *Phonology* 2, 85-138.
- Ladefoged, Peter. 2001. *A course in phonetics*. New York: Harcourt.
- Langacker, Ronald W. 1968. *Language and its Structure*. New York: Harcourt.
- Lombardi, Linda. 1990. "The Nonlinear Organization of the Affricate." *NLLT*, 8, 375-425.
- Lombardi, Linda. 1991. *Laryngeal features and laryngeal neutralization*. PhD dissertation, University of Massachusetts, Amherst.
- Lombardi, Linda. 1996. "Restrictions on direction of voicing assimilation: An OT account." *University of Maryland Working Papers in Linguistics*, 4.
- Luelsdorf, Philip A. 1969. "On the Phonology of English Inflection." *Glossa*, 3, 39-48.
- McCarthy, John. 1986. "OCP Effects: Gemination and antigemination." *LI*, 17, 207-263.
- Mester, Armin, and Junko Ito. 1989. "Feature predictability and underspecification: palatal prosody in Japanese mimetics." *Language*, 65, 258-293.
- Padgett, Jaye. 1994. "Stricture and nasal place assimilation." *NLLT*, 12, 463-513.
- Padgett, Jaye. 1995. *Stricture in Feature Geometry*. Dissertations in Linguistics Series. Stanford: CSLI Publications.
- Pinker, Steven, and Alan Prince. 1988. "On language and connectionism: Analysis of a parallel distributed processing model of language acquisition." In *Connections and Symbols (A Cognition Special Issue)*, S. Pinker and J. Mehler (eds.), 73-193. Cambridge: MIT/Bradford Books.
- Prince, Alan, and Paul Smolensky. 1993/2004. *Optimality Theory: Constraint interaction in generative grammar*. Malden, MA and Oxford: Blackwell.
- Prince, Alan. 2002. "Arguing Optimality." In *Papers in Optimality Theory II*, A. Coetzee, A. Carpenter and P. de Lacy (eds.). Amherst, MA: GLSA.
- Rose, Sharon. 2000. "Rethinking Gemminates, Long-Distance Gemminates, and the OCP." *LI*, 31, 85-122.
- Sagey, Elizabeth. 1986. *The representation of features and relations in nonlinear phonology*. PhD dissertation, MIT.
- Siegel, Dorothy. 1974. *Topics in English Morphology*. PhD dissertation, MIT.
- Yip, Moira. 1988. "The Obligatory Contour Principle and phonological rules: A loss of identity." *LI*, 19, 65-100.
- Zue, Victor W., and Stefanie Shattuck-Hufnagel. 1979. "The Palatalization of Alveolar Fricatives in American English." *ICPhS IX*, Copenhagen.

Eric Baković
Linguistics, UCSD
9500 Gilman Dr. #0108
La Jolla, CA 92093-0108
bakovic@ling.ucsd.edu

Semantic Underspecificity in English Argument/Oblique Alternations¹

John Beavers
Stanford University

1. Introduction

In this paper I investigate the lexical semantic basis of English argument/oblique alternations. I use the locative alternation in (1) as a case study.

- (1) a. John loaded the hay onto the wagon.
b. John loaded the wagon with the hay.

In (1a) *the hay*, which I refer to as the **locatum** participant, is realized as direct object, whereas the **location** participant *the wagon* is realized as a locative oblique. In (1b) the opposite pattern occurs, where the locatum is oblique and the location is direct object. The defining property of such alternations is that at least one participant varies in **morphosyntactic prominence** between variants, where direct arguments are more morphosyntactically prominent than obliques.² I base this terminology on the relative prominence of different morphological cases on a standard case markedness hierarchy, where direct argument (structural) cases are relatively unmarked compared to oblique cases. Although much work on alternations focuses on factors like topicality (Givón 1984) and heaviness (Wasow 2002), I focus on the semantic contrasts they exhibit.³ The classic observation about (1) is that the direct objects are holistically affected (all moved or filled, modulo the effects of bare plural/mass nouns; Verkuyl 1972), but obliques are underspecified for this (compatible with both holistic and non-holistic readings; Anderson 1971):

- (2) a. i. John loaded the hay onto the wagon, filling the entire wagon.
ii. John loaded the hay onto the wagon, and still had room left over.
iii.#John loaded the hay onto the wagon, and still had a bale left over.
b. i. John loaded the wagon with the hay, leaving none behind.
ii. John loaded the wagon with the hay, and still had a bale left over.
iii.#John loaded the wagon with the hay, and still had room left over.

I argue that these contrasts arise from subtle variations in **thematic roles** of the alternating participants, where thematic roles are defined as sets of entailments

following Dowty (1991). These sets are structured relative to one another in terms of “specificity,” captured as subset relationships between thematic roles. I argue that the principle in (3) governs the mapping from thematic roles to realization.

(3) **Morphosyntactic Alignment Principle:**

Oblique realizations have thematic roles that are underspecified for thematic role information encoded by direct argument realizations.

In §2 and §3 I show that (3) underlies a variety of alternations but that previous predicate decomposition-based analyses do not capture this directly. In §4 I outline an entailment-based approach to thematic roles following Dowty (1991), and in §5 I show how this approach captures the contrasts various alternations exhibit. In §6 I conclude with some discussion of the universal nature of (3).

2. Semantic Effects in Argument/Oblique Alternations

The locative alternation has been well discussed in the literature, as has the association of direct objects with holistic affectedness (see Anderson 1971, Tenny 1994, *inter alia*). But in fact many alternations exhibit similar contrasts *not always involving affectedness*. A sampling is given below (largely drawn from Levin 1993):

- (4) **Conative alternation** (Underspecified affectedness)
 - a. John slashed the canvas. (canvas affected)
 - b. John slashed at the canvas. (canvas possibly not affected)
- (5) **Dative alternation** (Underspecified possession/goal)
 - a. John threw/mailed Mary the ball. (Mary a goal and possessor)
 - b. John threw/mailed the ball to Mary. (Mary not necessarily possessor)
 - c. John threw the ball at Mary. (Mary not necessarily goal or possessor)
- (6) **Preposition drop alternation** (Underspecified holistic traversal)
 - a. John climbed the mountain. (entire mountain traversed)
 - b. John climbed up the mountain. (mountain possibly not all traversed)
- (7) **Reciprocal alternation** (Underspecified activeness/motion)
 - a. The truck and the car collided. (both car and truck in motion)
 - b. The truck collided with the car. (car possibly not moving)
- (8) **Search alternation I** (Underspecified degree of coverage)
 - a. John searched the woods for deer. (woods totally searched)
 - b. John searched in the woods for deer. (woods maybe not all searched)

- (9) **Search alternation II (Underspecified existence presupposition)**
 28 a. John hunted a unicorn in the woods. (unicorn presupposed to exist)
 b. John hunted in the woods for a unicorn. (unicorn might not exist)

In all cases the oblique is underspecified for something specified of the direct argument, which may be holistic affectedness, affectedness, activeness, possession, holistic coverage, or existence presuppositions, depending on the specific alternation. Thus while degree of affectedness is one source of alternations, it is not the only one. The unifying characteristic is the underspecificity of the oblique.⁴

3. Semantic Prominence - Structural or Semantic?

Early thematic role theories (e.g. Fillmore 1968) assumed that alternations simply reflect different options for the morphosyntactic realization of the same thematic roles, although this fails to capture the contrasts discussed in §2. More recent work derives alternations instead from lexical or constructional semantic representations (“predicate decompositions”) that capture the different semantics of each variant. A classic such analysis of (1) is given in (10), where *load* is polysemous between two event types: change-of-location vs. change-of-state (see Levin and Rappaport 1988, Pinker 1989, Jackendoff 1990, Gropen et al. 1991, *inter alia*).

- (10) a. John loaded hay onto the wagon. (change-of-location, cf. *put*)
 [x cause [y to come to be at z]/LOAD]
 b. John loaded the wagon with hay. (change-of-state, cf. *fill*)
 [[x cause [z to come to be in STATE]]
 BY MEANS OF [x cause [y to come to be at z]/LOAD]]
 (cf. Levin and Rappaport 1988, (24), p.26)

In (10a) *load* has a Lexical Conceptual Structure (LCS) representing a change-of-location, where the *y* participant is moved to the *z* participant (similar to *put*). In (10b) *load* is associated with a change-of-state LCS, where the *z* participant comes to be in a certain state by means of a change-of-location (cf. *fill*). Details aside, each structure makes a different participant more prominent (“higher” or “earlier” depending on the implementation) in the LCS. I refer to this as **semantic prominence**. Linking rules map semantically prominent arguments to morphosyntactically prominent positions in the verb’s Predicate Argument Structure (PAS), e.g. as in the following from Levin and Rappaport (1988, (21)-(22), p.25):

- (11) When the LCS of a verb includes one of the substructures in [(12)], link the variable represented by *x* in either substructure to the direct argument variable [the direct object - JTB] in the verb’s PAS.
 (12) a. ...[*x* come to be at LOCATION]...
 b. ...[*x* come to be in STATE]...

Thus in (10) either y or z is mapped to the direct object depending on the sense of *load*. A simple generalization emerges from approaches like this: 29

(13) Semantic prominence is reflected by morphosyntactic prominence.

This is a very satisfying generalization since it links the morphosyntax transparently to properties of the semantics. However, predicate decomposition approaches suffer from several drawbacks. Particular to the analysis in (10), there is no a priori reason why only (10b) involves a change-of-state, since in fact all loading events involve both a change of location for the locatum and some change in some property of the location (e.g. how loaded it is). Second, there is no a priori reason why there is a BY MEANS OF relation between the two subevents in (10b) nor why BY MEANS OF should encode the prominence relations it does, e.g. why (10b) isn't instead a change-of-location by means of a change-of-state. Although the intuition underlying the LCSs in (10) is that each sense of *load* focuses on or is primarily "about" a different participant, the particular shape of each LCS is motivated by the argument realization paradigms it is intended to explain rather than independent semantic criteria (see Koenig and Davis 2004 for further discussion).

However, most importantly, none of the entailments in §2 fall directly out of structures like those in (10). All the LCSs in (10) do is make certain participants more *structurally* prominent in the semantic representation. Any entailment differences between LCSs must be derived indirectly, and few theories have worked out exactly how this is the case. For example, Gropen et al. (1991, p.162) describe holistic affectedness as "most natural" when one or the other participant is more prominent in the underlying structure, but it is never explained why this should be, how these interpretations come about, or how it is that different entailment patterns should be relevant for different alternations. In the next section I instead take the relevant entailments as central and motivate a truly semantic analysis of argument/oblique alternations that captures these relationships directly.

4. Thematic Roles as Sets

I assume a theory of thematic roles as sets of entailments, based on the proto-role theory of Dowty (1991).⁵ On this approach, verbs assign to their participants very specific **individual thematic roles** (following Dowty 1989, p.76) as in (14).

(14) **Predicate** **Individual Thematic Roles**
build(x, y) $x \approx_{\text{BUILDER}}$ (= set of entailments associated with x by *build*)
 $y \approx_{\text{BUILDEE}}$ (= set of entailments associated with y by *build*)

In (14) each argument of *build* is assigned a very specific set of entailments that characterizes its role in a building event. Each individual thematic role may be more or less like one of two **proto-roles**. Proto-roles are not thematic roles per se but rather are sets of entailments representing canonical agents and patients, used

for determining argument realization.⁶ Dowty's proto-patient role, relevant for the discussion of the locative alternation in the next section, is given in (15).

- (15) Contributing properties for the Patient Proto-Role (Dowty 1991, (28), p.572):
- i. undergoes change of state
 - ii. incremental theme
 - iii. causally affected by another participant
 - iv. stationary relative to movement of another participant
 - v. does not exist independently of the event, or not at all

Direct arguments encode participants with the *most* proto-typical roles (i.e. have the most entailments in common with some proto-role) according to (16).

- (16) $\text{Subj}_V \approx \text{Proto-agent}_V$ (=V's most proto-agentive participant)
 $\text{DO}_V \approx \text{Proto-patient}_V$ (=V's most proto-patientive participant)
 (cf. the ARGUMENT SELECTION PRINCIPLE, Dowty 1991, (31)-(34), p.576)

The "proto-patient of *V*" is the participant of the event described by *V* whose role is most like the proto-patient in (15). With this as a backdrop, I now turn to how alternations are licensed and what semantic contrasts they indicate.

5. Some Alternations and Non-Alternations

Dowty's argument selection principle only applies to verbs that have a subject and object. It is clear from the data in §2, however, that some verbs also allow these participants to be realized as obliques. I assume that this possibility is licensed when a verb and an oblique marker in a given language assign compatible individual thematic roles (following Gawron 1986). For example, the core property of all locative alternating verbs is that the location is some kind of static location and the locatum is *causally intermediate*, i.e. intermediate in a force-dynamic chain relating the agent, locatum, and location, following Croft (1991):

- (17) *John* *hay* *wagon* (Participants)
 • → • → • (Force dynamic chain)

The force-dynamics in (17) involve the agent operating first on the locatum and then on the location, thus placing the locatum at an intermediate position in the force-dynamic relationships of the participants. Thus in terms of thematic roles, *load* assigns the following entailments to the locatum and location participants:

- (18) a. $\text{LCTM}_{load} = \left\{ \begin{array}{c} \dots \\ \text{x is causally intermediate} \\ \dots \end{array} \right\}$ b. $\text{LOC}_{load} = \left\{ \begin{array}{c} \dots \\ \text{x is a location} \\ \dots \end{array} \right\}$

Furthermore, English has two classes of oblique markers that also encode these entailments: the instrumental *with*-marker⁷ and various locative markers:

- (19) a. *with* = {x is causally intermediate} b. *onto* = {x is a location}

Since the roles in (18) subsume the roles in (19), this licenses the possibility that either participant could be realized either directly by the verb or as an oblique. This licensing condition makes broad predictions about when alternations will occur based on morphological inventories of particular languages. For example, in the dative alternation in (5a,b) the core property underlying both variants is that the recipient be a goal (where the first object is additionally specified for possession). Crucial, then, is the existence of an allative oblique goal-marker *to* in English. Romance languages, on the other hand, generally do not allow dative alternations like those in English. But crucially these languages also lack a general purpose goal-marker on a par with *to* (Talmy 2000). Thus the presence of an alternation in a language can partly be determined by the available oblique-marking inventory.

Turning now to the particular semantic contrasts exhibited by the locative alternation, I assume there are only two entailments relevant for determining the proto-patient of locative verbs. The first is what I refer to as **affectedness**, i.e. the general condition that some property (position, coverage, state, existence, etc.) of the participant has changed in the event (following the mereological approach to dynamic predicates in Beavers to appear; this subsumes “causally affected by another participant”, “does not exist independently of the event”, “undergoes change of state” in (15i,iii,v)). The second proto-patient property is **holistic affectedness**, i.e. affectedness where all of the participant has completely changed (cf. “incremental theme” in (15ii)). *Load* assigns the following location and locatum roles:

$$(20) \text{ a. } LCTM_{load} = \left\{ \begin{array}{l} x \text{ is affected} \\ x \text{ is holistically affected} \\ \dots \\ lctm \text{ properties} \\ \dots \end{array} \right\} \text{ b. } LOC_{load} = \left\{ \begin{array}{l} x \text{ is affected} \\ x \text{ is holistically affected} \\ \dots \\ loc \text{ properties} \\ \dots \end{array} \right\}$$

Each participant is licensed by the verb to be both affected and holistically affected, and in addition each role has some idiosyncratic location/locatum semantics which I largely ignore here but which includes the entailments in (18). Thus both participants are qualified to be the proto-patient of *load* and therefore its direct object. However, only one participant may actually be the direct object since only one direct object is ever licensed in English. The other participant must be realized by a compatible oblique marker if it is realized at all.

However, in §2, when an oblique alternates with a direct argument the oblique bears some of the same verb-assigned properties as the direct argument, but crucially not all of them. How does this come about? I assume this is due to the oblique-marking: when a verb-licensed participant is realized as an oblique, it is instead assigned its thematic role indirectly by the oblique marker (cf. *mediated θ -selection*; Pesetsky 1995). When this happens, the oblique marker assigns only a *subset* of the verb-assigned role. For *load*, the roles determined by the oblique

markers are specified for affectedness but underspecified for holistic affectedness. The proto-patient properties relevant for each option are as follows:

- (21) a. $DO_{load} = \left\{ \begin{array}{l} x \text{ is affected} \\ x \text{ is holistically affected} \\ \dots \end{array} \right\}$ b. $with_{load} = \left\{ \begin{array}{l} x \text{ is affected} \\ \dots \end{array} \right\}$ c. $onto_{load} = \left\{ \begin{array}{l} x \text{ is affected} \\ \dots \end{array} \right\}$

The exact role of the DO_{load} corresponds to the role assigned by *load* to either the locatum or location participant. For *with* and *onto* the roles are respectively the locatum or location role determined by the verb minus any entailments regarding holistic affectedness. But why this particular contrast? To answer this, consider the behavior of *cut* and *break*, which superficially seem to participate in something similar to the locative alternation (Fillmore 1970, 1977):

- (22) a. John cut/broke his foot on the rock. (foot affected, rock maybe not)
 b. John cut/broke the rock with this foot. (rock affected, foot maybe not)

The participants in (22) share causal intermediacy and locationhood in common. But here the direct objects are merely affected but not necessarily holistically (cf. *cut/break up*, which have holistic readings), and the obliques are underspecified even for this property. This means that the space of realization options regarding proto-role entailments for *cut* and *break* are those given in (23).

- (23) a. $DO_{cut/break} = \left\{ \begin{array}{l} x \text{ is affected} \\ \dots \end{array} \right\}$ b. $with_{cut/break} = \{ \dots \}$ c. $on_{cut/break} = \{ \dots \}$

The exact role of the $DO_{cut/break}$ is the locatum or location role, and for the two obliques it is the verb's locatum and location roles minus any entailments of affectedness. From (21) and (23) a pattern emerges. In all cases the oblique is *minimally underspecified* relative to the direct argument, i.e. obliques bear roles missing a single proto-patient entailment from the direct object realization. This still leaves open the question of why the contrasts line up as they do, i.e. why it is holistic affectedness vs. affectedness in one case and affectedness vs. underspecified affectedness in another. Potentially this follows from the nature of the entailments: holistic affectedness implies affectedness, so the contrasts indicate successively weaker degrees of affectedness along a natural implicational hierarchy. The contrast a verb exhibits depends on the degree of affectedness it assigns to its direct arguments. The thematic roles-to-realization mapping is given in (24).

- (24) a. Subject/object roles are determined by maximal prototypicality.
 b. Obliques form *minimal underspecificity contrasts* with corresponding direct arguments.

Finally, not all locative verbs alternate:

- (25) a. John put/*filled the water into the bucket.
 b. John filled/*put the water with the bowl.

Previous accounts (cf. Levin and Rappaport 1988) argue that *put* is simply a change-of-location and *fill* simply a change-of-state, but unlike *load* neither is polysemous, thus blocking an alternation. But as discussed in §3 this does not directly capture the relevant entailment contrasts. On the approach sketched here locative alternations arise from symmetric role assignments to two participants, each of which may be holistically affected. Non-alternations must therefore be due to *asymmetric* thematic role assignments. *Put* associates with its locatum the property of holistic affectedness (all of it is moved) but not its location (it is not necessarily all filled), whereas *fill* associates holistic affectedness with its location but not its locatum. Thus in each case only one participant can be the proto-patient and consequently the direct object, blocking an alternation. The other participant is realized with a compatible oblique marker. Since there is no possibility of an alternation there is no underspecificity of the verb role, and so the oblique marker takes on the complete role assigned by the verb. The full typology is given in (26).

(26)

verb	location	locatum
<i>cut</i>	{ x is affected }	{ x is affected }
<i>put</i>	{ x is affected }	{ x is affected x is holistically affected }
<i>fill</i>	{ x is affected x is holistically affected }	{ x is affected }
<i>load</i>	{ x is affected x is holistically affected }	{ x is affected x is holistically affected }

Why different verbs lexicalize different assignments is more of a mystery, though presumably this is partly due to functional pressure towards a full paradigm as well as the effects of components such as manner in each verb's meaning (see Dowty 1991, Gropen et al. 1991 for some discussion). But when locative alternations do arise it is because (a) a verb licenses an individual thematic role for a participant that is compatible with the inherent role of a particular oblique marker, (b) two participants are given symmetric thematic roles relative to a particular proto-role and thus either could be a direct argument, and (c) there are less direct argument realization options than participants. When all of these conditions obtain, one participant otherwise eligible to be a direct argument must be realized as an oblique and subsequently takes on a less specific role by the general principle in (24).

A slightly different situation occurs in alternations involving just a single participant, such as the conative and reciprocal alternations in (4) and (7). Again,

the alternations arise from compatibility between a verb-assigned role and the inherent role of some oblique marker (which presumably has to do with intended contact for *at*, following Laughren 1988, and reciprocity for *with*). The realization options are given in (27) and (28), where the underspecificity follows from (24).

- (27) a. John slashed (at) the curtain.
 b. $DO_{slash} = \left\{ \begin{array}{l} \text{x is affected} \\ \dots \end{array} \right\}$ c. $at_{slash} = \{ \dots \}$
- (28) a. The truck and the car collided/The truck collided with the car.
 b. $Subj_{collide} = \left\{ \begin{array}{l} \text{x moves independently} \\ \dots \end{array} \right\}$ c. $with_{collide} = \{ \dots \}$

The main difference between these alternations and the locative alternation is that there is no conflict for a direct argumenthood between two participants. Note that the underspecificity requirement explains why verbs that entail no affectedness do not undergo the conative alternation (cf. *John touched (*at) the paper*), since there is nothing to underspecificity (cf. Laughren 1988). This is of course not the entire story, since some change-of-state verbs that appear to involve contact still do not alternate (cf. **break at*). Thus further restrictions may be necessary. But the general framework outlined here is a crucial first step towards a general, entailment-based analysis of such alternations. Note also that (28) does not involve affectedness, highlighting the generality of this approach beyond the oft-discussed correlation of holistic affectedness to direct objecthood.

6. Conclusion and Further Work

To summarize, thematic roles are defined as sets of entailments, and realization options are determined as follows:

- (29) **Morphosyntactic Alignment Principle:**
 Oblique realizations have thematic roles that are underspecified for thematic role information encoded by direct argument realizations, where:
- a. Subject/object roles are determined by maximal prototypicality.
 - b. Obliques form *minimal underspecificity contrasts* with corresponding direct arguments.

Alternations are licensed when a verb assigns a role that is compatible with an oblique marker's inherent role, where (29) determines the thematic role of each realization option. Of course, not all alternations show semantic contrasts (cf. *John blamed Mary for his problems/his problems on Mary*), although given the range of semantic and non-semantic factors governing argument realization there is no reason to assume that the contrasts explored here underlie all alternations. But

when alternations are semantically governed, it is always of the form described here. Note that this approach expands the approach of Dowty (1991) since it gives a uniform characterization to oblique roles (underspecificity) and also covers transitivity alternations, something Dowty explicitly ignores. Likewise, the approach here differs from the related approach of Ackerman and Moore (2001) in particular ways. Ackerman and Moore propose that obliques simply bear “less prototypical” thematic roles than direct arguments (their PARADIGMATIC ARGUMENT SELECTION PRINCIPLE, *ibid.*, (2), p.169). On my approach “less prototypical” corresponds directly to minimal underspecificity, a stronger condition. Furthermore, my approach provides a key to understanding what licenses alternations and which obliques show up in which alternations in terms of shared semantics. Finally, the principle in (29) is not *necessarily* keyed to prototypicality (although I assume it is for subjects and objects), and thus is compatible with alternations such as the dative alternation, for which there may not exist a proto-recipient role even if the first object/*to* contrast is nonetheless one of underspecificity as in §2.

Furthermore, this approach has significant cross-linguistic validity in a variety of domains. For example, accusative/dative causee marking in Japanese and French derived causatives indicate greater or lesser specificity of how directly the causee is manipulated by the causer (Shibatani 1973, Authier and Reed 1991), and dative/oblique marking for goals of motion in so-called “verb-framed” languages corresponds to specificity contrasts in the goal-like nature of the participant (Beavers 2004). But why should such contrasts exist, and why would they be universal? For a tentative answer to this, consider again the principle in (13) relating morphosyntactic and semantic prominence in predicate decompositions:

(30) Semantic prominence is reflected by morphosyntactic prominence.

The approach outlined here allows us to give this principle some genuine semantic teeth by defining semantic prominence not in terms of structural positions in decompositions but rather in terms of thematic role information:

(31) A participant is more semantically prominent if it has a more specific thematic role.

In other words, *languages encode most economically what you say most about*, giving greater prominence to participants more central to the event as determined semantically. This principle is just one piece of the larger puzzle of argument realization, and operates in tangent with discourse/information structural factors and semantic properties such as animacy and humanness that I have largely ignored here. The interaction of these factors is a matter of future work. Likewise, further work will necessarily involve addressing the questions of why it is the entailments should line up as they do and furthermore why certain verbs and verb classes participate in some alternations but not others, all questions I touched upon tentatively here but have not proposed definitive answers to yet.

Notes

¹I'd like to acknowledge the support of the LinGO project at CSLI. I'd also like to thank Seongsook Choi, Itamar Francez, Heidi Harley, Philip Hofmeister, Martin Kay, Yong-Taek Kim, Paul Kiparsky, Beth Levin, Jean-Philippe Marcotte, Tanya Nikitina, Ivan Sag, Tom Wasow, and Arnold Zwicky for their thoughts and suggestions. Any oversights or omissions are entirely my own.

²I exclude here direct argument/direct argument alternations such as voice or causative alternations.

³I ignore here factors such as animacy and humanness — properties of referents which Evans (1997) calls “cast” properties. I focus instead purely on the roles participants play in the event.

⁴One could argue that holistic affectedness is a by-product of aspect since it brings with it a telic interpretation of the predicate (following Tenny 1994, *inter alia*). However, though telicity and affectedness are intertwined in many ways, they do not necessarily correlate, since one can find atelic resultative verbs (e.g. degree achievements like *cool*) and telic non-resultative verbs (e.g. semelfactives like *tap*; Beavers to appear). Thus holistic affectedness must be viewed as distinct from telicity

⁵I use “entailment” in the sense of Dowty’s (1989, p.75) “lexical entailments”, i.e. properties a verb assigns to an entity due to its role in an event, ignoring their status as e.g. entailments vs. implicatures.

⁶I ignore recipients for the rest of this paper, which I do not assume follow from a proto-role analysis though they are covered by the same generalization in (3).

⁷This use of *with* is often thought of as a “displaced theme” marker (Levin and Rappaport 1988), i.e. it marks a theme that has been knocked out of direct object status by the location. However, displaced themes share the property of causal intermediacy with instruments (see Croft 1991, p.178 on instruments) and thus I assume they share the same marker, though they are licensed in different ways.

References

- Ackerman, Farrell and John Moore. 2001. *Proto-Properties and Grammatical Encoding: A Correspondence Theory of Argument Selection*. Stanford, CA: CSLI Publications.
- Anderson, Stephen R. 1971. “On the role of deep structure in semantic interpretation”, *Foundations of Language*, 7.3:387–396.
- Authier, J.-Marc and Lisa Reed. 1991. “Ergative predicates and dative cliticization in French causatives”, *Linguistic Inquiry*, 22.1:197–205.
- Beavers, John. 2004. “On the nature of goal markers and event delimiters: Evidence from Japanese”, Unpublished Ms., Stanford University.
- Beavers, John. To appear. “Scalar complexity and the structure of events”, In J. Dölling and T. Heyde-Zybatow, eds., *Event Structures in Linguistic Form and Interpretation*. Berlin: Mouton de Gruyter.
- Croft, William. 1991. *Syntactic Categories and Grammatical Relations: The Cognitive Organization of Information*. Chicago: University of Chicago Press.
- Dowty, David. 1989. “On the semantic content of the notion ‘thematic role’”, In G. Chierchia, B. H. Partee, and R. Turner, eds., *Properties, Types, and Meaning*. Dordrecht: Kluwer Academic Publishers.
- Dowty, David. 1991. “Thematic proto-roles and argument selection”, *Language*, 67.3:547–619.
- Evans, Nick. 1997. “Role or cast? noun incorporation and complex predicates in Mayali”, In A. Alsina, J. Bresnan, and P. Sells, eds., *Complex Predicates*, pages 397–430. Stanford, CA: CSLI Publications.
- Fillmore, Charles J. 1968. “The case for case”, In E. Bach and R. T. Harms, eds., *Universals in Linguistic Theory*. New York: Holt.
- Fillmore, Charles J. 1970. “The grammar of *Hitting* and *Breaking*”, In R. Jacobs and

- P. S. Rosenbaum, eds., *Readings in English Transformational Grammar*, pages 120–133. Waltham, MA: Ginn.
- Fillmore, Charles J. 1977. “The case for case reopened”, In P. Cole and J. M. Sadock, eds., *Grammatical Relations*, pages 59–82. New York: Academic Press.
- Gawron, Jean Mark. 1986. “Situations and prepositions”, *Linguistics and Philosophy*, **9**:327–382.
- Givón, Talmy. 1984. “Direct object and dative shifting: Semantic and pragmatic case”, In F. Plank, ed., *Objects: Towards a Theory of Grammatical Relations*, pages 151–182. London: Academic Press.
- Gropen, Jess, Steven Pinker, Michelle Hollander, and Richard Goldberg. 1991. “Affectedness and direct objects: The role of lexical semantics in the acquisition of verb argument structure”, *Cognition*, **41.2**:153–195.
- Jackendoff, Ray. 1990. *Semantic Structures*. Cambridge, MA: MIT Press.
- Koenig, Jean-Pierre and Anthony Davis. 2004. “The KEY to lexical semantic representations”, Unpublished ms., University at Buffalo, the State University of New York.
- Laughren, Mary. 1988. “Toward a lexical representation of Warlpiri verbs”, In W. Wilkins, ed., *Thematic Relations*. San Diego, CA: Academic Press.
- Levin, Beth. 1993. *English Verb Classes and Alternations: A Preliminary Investigation*. Chicago: University of Chicago Press.
- Levin, Beth and Malka Rappaport. 1988. “What to do with θ -roles”, In W. Wilkins, ed., *Thematic Relations*. San Diego, CA: Academic Press.
- Pesetsky, David. 1995. *Zero Syntax*. Cambridge, MA: MIT Press.
- Pinker, Stephen. 1989. *Learnability and Cognition*. Cambridge, Mass: MIT Press.
- Shibatani, Masayoshi. 1973. “Semantics of Japanese causativization”, *Foundations of Language*, **9.3**:327–373.
- Talmy, Leonard. 2000. *Toward a Cognitive Semantics: Typology and Process in Concept Structuring*. Cambridge, Mass.: MIT Press.
- Tenny, Carol L. 1994. *Aspectual Roles and the Syntax-Semantic Interface*. Dordrecht: Kluwer Academic Publishers.
- Verkuyl, Henk J. 1972. *On the Compositional Nature of the Aspects*. Dordrecht: Reidel.
- Wasow, Thomas. 2002. *Postverbal Behavior*. Stanford, CA: CSLI Publications.

John Beavers
 Department of Linguistics
 Stanford University
 Stanford, CA, 94305-2150
 jbeavers@csl.stanford.edu

Some Speculations on the Noun Phrase Structure of Jingpo^{*}

Candice Cheung Chi Hang

Department of Linguistics, University of Southern California

1. Introduction

This paper focuses on a far less-studied language, Jingpo – a Tibeto-Burman language that allows the demonstrative to appear either prenominal or postnominally. One of the major goals of this paper is to accommodate the different distribution of the demonstrative in the language. Another goal of this paper is to provide an adequate account for adjectives, since it has been noted in the literature (Gu & Dai 2003) that they can appear in either prenominal or postnominal position (though with slightly different forms).

This paper is organized as follows: in the following section, some background information about Jingpo will be provided. In section 3, I will illustrate the different properties of prenominal and postnominal adjectives, and I will argue that prenominal and postnominal adjectives have different statuses. The properties of the demonstratives in Jingpo as well as its distributional patterns will be examined in section 4. In section 5, I will provide a principled account for the different placements of the demonstrative. Some concluding remarks will be given in section 6.

2. Background Information about Jingpo

Jingpo belongs linguistically to the Kachinic group within the Tibeto-Burman family, and is spoken by the Jingpo ethnic group who mainly reside in three different regions, including the northeastern part of Myanmar (formerly Burma), the contiguous areas of India (Arunachal Pradesh and Nagaland), and China (Yunnan). Like most languages belonging to the Tibeto-Burman family, Jingpo is a SOV language.

The Jingpo data presented in this paper are of two principal types: written and oral. The written data are drawn from a number of different sources, including Jingpo-Chinese dictionary (Xu et. al. 1983), grammar books (Liu 1984, Dai & Xu 1992) and current research on the grammar of Jingpo (Dai 1998, Dai & Gu 2003, among many others). As for the oral data, they are principally collected from my native informants who reside in Dehong Dai-Jingpo autonomous prefecture in

Yunnan province and Burma. The data presented in this paper are based on colloquial spoken Jingpo.

3. The Distribution of Adjectives

In Jingpo, the distribution of adjective is relatively ‘free’, as it may occur immediately before or after the noun, as illustrated in the following examples:¹

- (1) a. gaba ai hpun b. hpun gaba
 big MOD tree tree big
 ‘big tree’ ‘big tree’ (Dai & Xu 1992: 325)

Note that prenominal adjectives must be followed by the modifying marker *ai* (abbreviated as MOD in (1a) and (2a)); whereas for postnominal adjectives, the presence of *ai* is always barred (2b):²

- (2) a. hkye *(ai) hte tsom *(ai) nampan nhtan masum
 red MOD and beautiful MOD flower C^{bunch} three
 ‘three bunches of red and beautiful flowers’ (Gu & Dai 2003: 87)
 b. Nta gaba (*ai) dai hkik hkik ai wa!
 building big MOD that magnificent REDUP 3SG(Subj)STA EXC
 ‘That big building is very magnificent!’

Gu & Dai (2003) provide extensive evidence arguing that postnominal adjectives (as in (1b) and (2b)) should be analyzed as a compound with the internal structure [head + modifier], whereas the prenominal adjective plus *ai* (as in (1a) and (2a)) should be analyzed as a modifier which adjoins to the noun phrase. Let us review some of the evidence for treating [N(oun) + Adj(ective)] as a compound. In Jingpo, when a disyllabic noun forms a compound with an adjective, the first syllable of the noun is often deleted, with the resulting compound ending up with the last syllable of the noun plus the adjectives. Some typical examples are shown below (adopted from Gu & Dai 2003: 76):

- (3) nampan → pan + hkye → panhkye
 ‘flower’ ‘red’ ‘red flower’
 (4) hpunpyen → pyen + chyang → pyenchyang
 ‘board’ ‘black’ ‘blackboard’

In addition, Gu & Dai show that the compounds thus formed always resist modification from adverbs, as shown by the contrast between examples (a) and (b) below (adopted from Gu & Dai 2003: 76-77):

- (5) a. panhkye b. *pan-grai-hyke
 ‘red flower’ Intended reading: ‘very red flower’
 (6) a. pyenchyang b. *pyen-nau-chyang
 ‘blackboard’ Intended reading: (Lit.) ‘too black board’

Second, Gu & Dai show that there are many compounds in Jingpo which have the head-initial structure (examples in (7) are adopted from Gu & Dai 2003: 85):

- | | | | | | | | | |
|--------|-------|-----------------|--|---------------------|---------|--|-------------|-------|
| (7) a. | ma | bau | | hkrai | noi | | lung | nep |
| | child | adopt | | bridge | suspend | | stone | bed |
| | | ‘adopted child’ | | ‘suspension bridge’ | | | ‘bed stone’ | |
| b. | *bau | ma | | *noi | hkrai | | *nep | lung |
| | adopt | child | | suspend | bridge | | bed | stone |

Based on the above evidence, Gu & Dai conclude that [N + Adj] as shown in (1b) and (8) above must be analyzed as a compound. However, note that their argument is incomplete, since for one thing, the compounds shown in (7) do not involve the [N + Adj] form, and the fact that these compounds always show head-initial structure does not necessarily imply that all N-initial elements must be treated as compounds. For another, while they have shown that compounds derived from [N + Adj] resist adverb modification (5-6), they have not provided direct evidence showing that [N + Adj] (as in (1b) and (2b)) also shares the same property. In what follows, I will provide crucial evidence showing that prenominal and postnominal adjectives should be analyzed as having different statuses in the language.

3.1 Different properties of [Adj + ai + N] and [N + Adj]

Prenominal adjectives are different from postnominal ones in (at least) three respects: first, while [Adj + ai + N] always allows adverb modification, [N + Adj] does not (8a-b):

- | | | | | | | | | | |
|--------|------|-----------------|-----|------|----|------------|---------|------|---------|
| (8) a. | grai | gaba | ai | hpun | b. | hpun | (*grai) | gaba | (*grai) |
| | very | big | MOD | tree | | tree | very | big | very |
| | | ‘very big tree’ | | | | ‘big tree’ | | | |

The fact that [N + Adj] always resists adverb modification provides important support for the view that it has the status of a compound, since recall that those derived from [N + Adj] (as in (5-6)) have essentially the same property.

Second, prenominal and postnominal adjectives differ in terms of conjunction. As shown in (9), [Adj + ai] can always be conjoined by the connective *hte* ‘and’. However, only [N + Adj], but not postnominal adjectives alone, can be conjoined by *hte*, as demonstrated by the contrast between (10a) and (10b).

- | | | | | | | | | |
|---------|---------|-------|-----|--|---------------------|---------------------|---------------------|-------|
| (9) | hkye | *(ai) | hte | tsom | *(ai) | nampan | nhtan | masum |
| | red | MOD | and | beautiful | MOD | flower | CI ^{bunch} | three |
| | | | | ‘three bunches of red and beautiful flowers’ | | | | |
| (10) a. | *nampan | hkye | hte | tsom | nhtan | masum | | |
| | flower | red | and | beautiful | CI ^{bunch} | three | | |
| b. | nampan | hkye | hte | nampan | tsom | nhtan | masum | |
| | flower | red | and | flower | beautiful | CI ^{bunch} | three | |
| | | | | ‘three bunches (in which there are) red flowers and beautiful flowers’ | | | | |

In addition, note that (9) and (10) have different interpretations: the only reading for (9) is that all flowers in the three bunches are both red and beautiful, whereas the form in (10) means that within the three bunches of flowers, there are two types of flowers, namely, red flowers and beautiful flowers.

Third, it is noted that multiple occurrence of different [Adj + *ai*] forms is always allowed (11), whereas for postnominal adjectives, only a single adjective can show up, as illustrated by the contrast between (12a-c) and (12d).

- (11) gaba *(ai) hkye *(ai) dui *(ai) myin *(ai) namsi
 big MOD red MOD sweet MOD ripe MOD fruit
 'big red sweet ripe fruit(s)'
- (12) a. *namsi myin dui hkye gaba
 fruit ripe sweet red big
 Intended reading: 'big red sweet ripe fruit(s)'
- b. *namsi dui hkye gaba
 fruit sweet red big
 Intended reading: 'big red sweet fruit(s)'
- c. *namsi hkye gaba
 fruit red big
 Intended reading: 'big red fruit(s)'
- d. namsi gaba
 fruit big
 'big fruit(s)'

Based on the fact that [N + Adj] behaves like compounds in that both resist modification by adverbs (see (5-6) above) and that multiple postnominal adjectives are always barred in Jingpo, I argue that [N + Adj] is best-analyzed as a compound with the noun being the head, as schematized in (13):

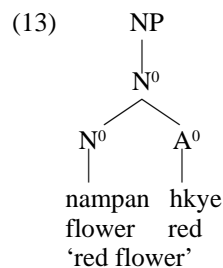

Having established that [N + Adj] has the status of a compound in Jingpo, I will turn to prenominal adjectives in the next section.

3.2 Analysis for prenominal adjectives

As demonstrated in the previous section, prenominal adjectives differ from postnominal ones in three crucial respects: first, they allow adverb modification while postnominal ones don't. Second, conjunction of two prenominal [Adj + *ai*]

forms by *hte* ‘and’ is possible but it is always barred when postnominal adjectives alone are conjoined. Third, multiple [Adj + *ai*] forms are always permissible when appearing prenominally but only a single adjective can show up postnominally. Further investigation into this third property of prenominal adjectives reveals a stark contrast between English and Jingpo in terms of the ordering restrictions on adjectives. A well-known fact about English adjectives is that they exhibit a rigid order: Adj_{quality} > Adj_{size} > Adj_{color} (14). In contrast, multiple [Adj + *ai*] forms preceding the noun can be randomly ordered in Jingpo (15):³

- (14) a. a wonderful big red car b. *a red big wonderful car
- (15) a. gaba *(ai) hkye *(ai) dui *(ai) myin *(ai) namsi hkum mi
 big MOD red MOD sweet MOD ripe MOD fruit Cl one
 ‘one big red sweet ripe fruit’
- b. myin *(ai) dui *(ai) hkye *(ai) gaba *(ai) namsi hkum mi
 ripe MOD sweet MOD red MOD big MOD fruit Cl one
 ‘one ripe sweet red big fruit’
- c. dui *(ai) hkye *(ai) gaba *(ai) myin *(ai) namsi hkum mi
 sweet MOD red MOD big MOD ripe MOD fruit Cl one
 ‘one sweet red big ripe fruit’
- d. hkye *(ai) dui *(ai) myin *(ai) gaba *(ai) namsi hkum mi
 red MOD sweet MOD ripe MOD big MOD fruit Cl one
 ‘one red sweet ripe big fruit’

Given the fact that there is no fixed ordering of multiple [Adj + *ai*] forms, I adopt the adjunction analysis, and assume that APs, which host [Adj + *ai*], are adjuncts to NP (see Jackendoff 1977, Valois 1991, Bernstein 1993, Ernst 2002, among others). On this view, noun phrases with multiple prenominal adjectives like (15a) will yield the structure in (16):

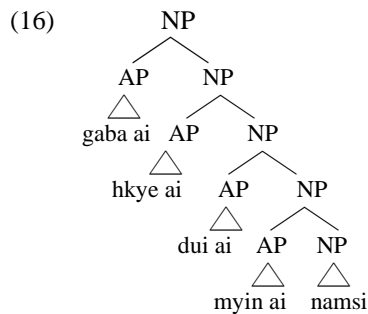

Note that in (16), I have assumed that the prenominal APs have a ‘nested structure’ with the higher AP c-commanding the lower ones, given the fact that the higher APs do not modify the head noun alone, as in the case of coordination structure (for instance, a typical example would be ‘a red, wonderful and big flower’ in English, where each of the adjectives modifies only the head noun). Rather, the higher APs always modify the lower constituent that includes the c-

commanded APs and the head noun, viz., it has a similar reading to the English example in (14a). In other words, despite the fact that Jingpo differs from English with respect to the ordering restrictions of prenominal APs, the two languages are quite similar in that both exhibit a nested interpretation for noun phrases with prenominal adjectives.

To briefly summarize, I have shown that prenominal and postnominal adjectives should be analyzed as having different statuses in the language: the former being part of a compound, whereas the latter are adjuncts that modifies NP.

4. The Distribution of Demonstratives

Jingpo, similar to other classifier languages, does not possess definite or indefinite articles. However, in contrast to most languages that have only two or three demonstratives locating the referents at different points on a distance scale, e.g., a proximal demonstrative such as *this* in English, and its corresponding distal demonstrative *that*, Jingpo has three additional demonstratives, which indicate whether the referent is at a higher, level or lower elevation relative to both speaker and hearer. A summary of the semantic properties of these five demonstratives is given in Table 1 below:

Table 1. Demonstratives in Jingpo

Proximal (Near Speaker)	ndai
Distal (Near Hearer)	dai
Up (Away from Speaker and Hearer)	htora
Level (Away from Speaker and Hearer)	wora
Down (Away from Speaker and Hearer)	Lera

The demonstratives in Table 1 can all appear in the topic position. This indicates that they are independent elements, as exemplified in (17):

- (17) Dai go nye a n re.
 that TOP my GEN NEG be
 ‘That is not mine.’ (Dai & Xu 1992: 193)

Extensive documentation on the grammar of Jingpo (see Liu 1984, and Dai & Xu 1992) has shown that the distribution of the demonstrative is relatively free. All the demonstratives in table 1 can either precede or immediately follow the noun is also supported by its distributional patterns when co-occurring with other elements in the noun phrase, including the prenominal adjective, classifier, numeral and the noun, as demonstrated by the contrast in well-formedness between (18a-b) and (18c-d). (for clarity, the whole noun phrases are underlined and the demonstratives are put in boldface).⁴ Note that (18a-b) have exactly the same interpretation despite the different placements of the demonstratives. In addition, the contrast between (18a) and (18e) further indicates that the prenominal demonstrative can only precede, but not follow, the adjective. Put differently, the adjective must be adjacent to the noun (18a-b, 18e). Also note that the presence of the topic marker *go* is always optional in Jingpo.

- (18) a. Ndai (gaja ai) n-gu kyin masum (go) grai hpro ai.
 this good MOD rice Cl^{catty} three TOP very white 3SG(Subj)STA
 ‘These three catties of good rice are very white.’
- b. (Gaja ai) n-gu **ndai** kyin masum (go) grai hpro ai.
 good MOD rice this Cl^{catty} three TOP very white 3SG(Subj)STA
 ‘These three catties of good rice are very white.’
- c. *(Gaja ai) n-gu kyin **ndai** masum (go) grai hpro ai.
 good MOD rice Cl^{catty} this three TOP very white 3SG(Subj)STA
- d. *(Gaja ai) n-gu kyin masum **ndai** (go) grai hpro ai.
 good MOD rice Cl^{catty} three this TOP very white 3SG(Subj)STA
- e. *(Gaja ai) **ndai** n-gu kyin masum (go) grai hpro ai.
 good MOD this rice Cl^{catty} three TOP very white 3SG(Subj)STA

The above data show that Jingpo noun phrases allow only two possible orders, which are listed below:

- (19) a. [Dem + (Adj + ai) + N + Cl + Num] (=18a)
 b. [(Adj + ai) + N + Dem + Cl + Num] (=18b)

In what follows, I will provide a unified account for the relatively free distribution of the demonstratives manifested in Jingpo noun phrases.

5. A Unified Account

Before turning to the question of how the relatively ‘free’ distribution of the demonstrative can be captured under a principled account, I would like to discuss the feature composition of demonstratives, and suggest that it should be distinct from definite articles. First, as argued in Bennett (1978), when one says *this/that book*, one is actually saying *the book here* or *the book there*. This can be attributed to the general properties of demonstratives in natural languages that require demonstration. This can be done by an actual pointing gesture or it can be made explicit in the discourse by the addition of locative elements such as *here* or *there* that makes clear which place/location is intended, as demonstrated in the following examples ((20a-b) are drawn from Kayne 2004, and (21a-b) are from Bernstein 1997: 91):

- (20) a. this here book b. that there book (nonstandard English)
 (21) a. cette femme-ci b. ce livre-lá (French)
 this woman-here that book-there
 ‘this woman’ ‘that book’

Following Bennett’s insight and also Jean-Roger Vergnaud’s remarks (personal communication), it is logical to conceive that demonstratives in natural languages are composed of three different features, including (i) the [+def] feature, (ii) the [deictic] feature, and (iii) the ‘place’ or ‘location’ feature that can be ascribed to the locative elements like *here* or *there* that can be either overt or covert. In contrast, definite articles in simplex noun phrases like ‘the book’ simply have the [+def] feature. Note that the different feature compositions of demonstratives vs.

definite articles are also reflected in their different acceptabilities in various types of clauses.⁵ For instance, it has been noted in Bernstein (1997) that only definite articles, but not demonstratives with definite interpretation, are allowed in restrictive relative clauses, as illustrated below ((22b) and (23b-c) are from Bernstein 1997: 102):

- (22) a. the guy that I know (nonstandard English)
 b. this here guy that I know
 ‘a guy that I know’ (NOT: ‘this guy that I know’)
- (23) a. le livre que j’ai acheté (French)
 the book that I-have bought
 ‘the book that I have bought’
 b. *ce livre que j’ai acheté ci
 this book that I-have bought here
 Intended: ‘this book that I have bought’ (NOT: ‘a book that I have bought’)
 c. *ce livre-ci que j’ai acheté
 this book-here that I-have bought
 Intended: ‘this book that I have bought’ (NOT: ‘a book that I have bought’)

In addition, according to Bernstein, the locative element can show up only with the presence of the demonstrative but not vice versa, as demonstrated in (24-25):

- (24) this/that (here) book vs. *here/there book (nonstandard English)
 (25) ce livre jaune(-la) vs. *livre jaune-la (French)
 that book yellow book yellow-there
 ‘that yellow book’

In order to capture the dependency relation between the locative element and demonstrative, Bernstein proposes that the locative element occupies the head of a function projection that I label as LocP, and the demonstrative is always base-generated in Spec-LocP position, whether or not the locative is present (see also Schmitt 2000 for similar proposal). Moreover, she assumes that the LocP takes the Number Phrase (NumP), i.e., the host of [singular/plural] feature, as its complement, as shown in (26):

- (26) [LocP this [Loc⁰ here] [NumP [Num⁰ book_k] [NP t_k]]] (nonstandard English)

Adopting Bernstein’s proposal that the demonstrative occupies the Spec of LocP, where the head position of LocP can be filled or empty, I suggest that Loc⁰ is the locus of [deictic] feature, and the locative elements can optionally appear in such position to specify the location. Additionally, assuming that demonstratives have a uniform structure in natural languages, I propose that the demonstrative in Jingpo occupies the Spec-LocP position, and Loc⁰ subcategorizes NumP as its complement, similar to the case found in English (see (26) above).⁶ Following Tang’s (1990) proposal that the noun phrase structure of Mandarin is composed of four distinct layers: (i) DP as the locus of definiteness (a la Li 1999), (ii) NumP as the host of numerals, (iii) CIP as the host of classifiers, and (iv) NP that serves as the lexical or substantive layer, I assume that the noun phrase structure of

Jingpo is exactly the same as Mandarin, except that the former is head-final, given that Jingpo is widely accepted as a strictly head-final language (Dai & Gu 2003).⁷ Following these assumptions, noun phrases with demonstrative would then have the underlying structure schematized in (27a). Since noun phrases with demonstrative in Jingpo, like those in Mandarin, must be interpreted as definite, I further propose that the demonstrative must raise to Spec-DP before Spell-Out to check off the [+def] feature through Spec-head agreement, as in (27b).

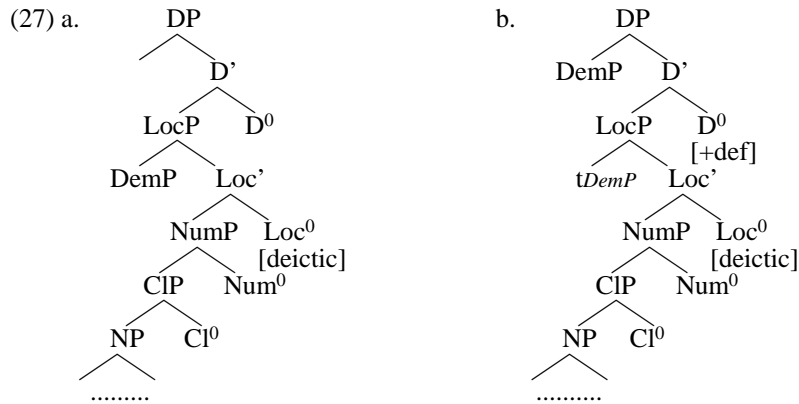

As shown in (27b), the proposed analysis has an additional advantage of nicely accommodating the prenominal distribution of the demonstrative as manifested in the [Dem + (AP) + N + Cl + Num] order.

While noun phrases with either prenominal or postnominal placement of the demonstrative seem to have the same meaning (see (19-20) above), it should be noted there are contexts in which the [(AP) + N + Dem + Cl + Num] order is preferred. There is tendency to use this order when the referent denoted by the noun is taken as new information or being contrasted. For instance, the [(AP) + N + Dem + Cl + Num] order is preferred in contexts like (28) ('#' is used to indicate the oddness of the sentence), where *n-gu* 'rice' is taken as the new information.

- (28) a. Shi a rai gara ra re ni?
his GEN thing which REDUP be 3SG(Subj)STA.Q
'Which item(s) belong(s) to him?' (Dai and Xu 1992: 58)
- b. Hpro ai n-gu ndai kyin masum go shi a re.
white Mod rice this Cl^{catty} three TOP his GEN be
'Those three catties of white rice are his.'
- c. #Ndai hpro ai n-gu kyin masum go shi a re.
this white MOD rice Cl^{catty} three TOP his GEN be
'Those three catties of rice are his.'

Alternatively, when the head nouns *n-gu* 'rice' and *namsi* 'fruit' are contrasted as in (29) (which may be used as the first utterance by a customer in the market), the same order is also preferred.

- (29) a. Ngai go n-gu ndai kyin masum hpe ra nngai,

- I TOP rice this Cl^{catty} three AOM want 1SG(Subj)STA
 namsi ndai hkum mali hpe n ra nngai.
 fruit this Cl four AOM NEG want 1SG(Subj)STA
 (Lit.) ‘I want these three catties of rice, I don’t want these four fruits.’
- b. #Ngai go n-gu ndai kyin masum hpe ra nngai,
 I TOP rice this Cl^{catty} three AOM want 1SG(Subj)STA
 ndai namsi hkum mali hpe n ra nngai.
 this fruit Cl four AOM NEG want 1SG(Subj)STA
 (Lit.) ‘I want these three catties of rice, I don’t want these four fruits.’

Based on the fact that the N-initial order is always preferred when the referent of the NP is interpreted as new information or when the NP is involved in contrastive focus structure, I suggest that the [(AP) + N + Dem + Cl + Num] order is derived by phrasal movement of NP (along with the prenominal AP adjuncts) to Spec-Focus Phrase (FocP), and the movement is triggered by Focus. Following this proposal, noun phrases with the [(AP) + N + Dem + Cl + Num] order would have the structure shown in (30):

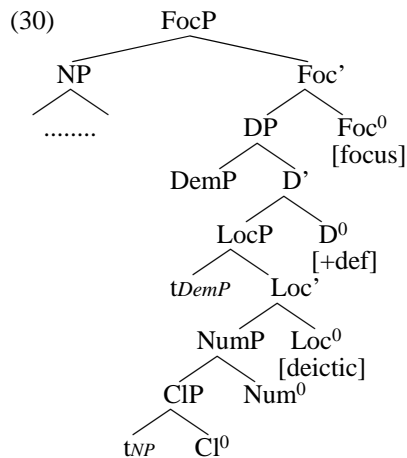

Given the structure in (30), it is expected that phrasal movement of NP only takes place when the FocP is present. Since I have shown that the N-initial order is only preferred in certain specific contexts, it is plausible to assume that FocP is projected only in those contexts, hence explaining the optionality of the NP movement.

In sum, I have suggested that the [(AP) + N + Dem + Cl + Num] order is derived by phrasal movement of NP (along with its adjoined prenominal APs), which is triggered by Focus.

6. Concluding Remarks

This paper is primarily concerned with the noun phrase structure of Jingpo, and the central goal is to provide a principled account for the prenominal/postnominal

alternations among adjectives and demonstratives in the language. I have shown that prenominal and postnominal adjectives have different properties, and thus should be analyzed as having different statuses in the language. More precisely, I have argued that prenominal adjectives with the modifying marker *ai* are NP adjuncts, whereas postnominal ones are part of a [N + Adj] compound. If the account developed here is on the right track, it may shed light on other languages, which also exhibit the random ordering of prenominal adjectives (for instance, Mandarin, Cantonese, etc.).

To account for the two permutations of the demonstratives, I have proposed that the demonstrative is base-generated in Spec-LocP position, with the head LocP position being the locus of [deictic] feature. The LocP is assumed to be subcategorized by the DP, and it in turn takes NumP as its complement. The proposal is supported by evidence from many different sources, including (i) the different feature composition of definite articles vs. demonstratives, and (ii) the different behaviors of definite articles and demonstratives in various types of constructions, such as relative clauses. Following this proposal, I have further assumed that demonstrative must raise into Spec-DP before Spell-Out to check off the [+def] feature. This allows us to capture the [Dem + (AP) + N + Cl + Num] order. In order to accommodate the alternative order, i.e., [(AP) + N + Dem + Cl + Num], I have argued that NP (with its adjoined prenominal AP) undergoes phrasal movement to Spec-FocP position, based on the observation that this order is always preferred in specific contexts.

On a more general level, the proposal that demonstratives involve a more complex structure in classifier languages has important repercussions on any analyses which attempt to account for word order variations within nominal expressions across this type of languages. Unlike the alternative analysis which assumes a universal underlying noun phrase structure, and identifies demonstratives as D⁰ elements in classifier languages, the current proposal calls for attention to the different feature composition of demonstratives and definite articles, despite the fact that classifier languages usually do not possess (in)definite articles. The recognition that demonstratives and definite articles do not necessarily form a homogenous class even in classifier languages can potentially lead to a more satisfactory explanation for the otherwise unexpected variations attested across languages.

Notes

* My deepest thanks go to my Jingpo informants in Yunnan and Burma who have been very helpful in providing me with the Jingpo data. I am especially indebted to Hagit Borer, Audrey Li, Stephan Matthews, Roumyana Pancheva, Andrew Simpson, Jean-Roger Vergnaud and Maria Luisa Zubizarreta for their insightful comments on earlier version of this paper. All errors are of course my own.

¹ The following abbreviations are used in glossing examples: Adj=adjective; AOM=animate object marker; ASP=aspect; AUX=auxiliary; Num=Numeral; Cl=classifier; Dem=demonstrative; GEN=genitive marker; MOD=modifying marker; N=noun; NEG=negation; PERF=perfective aspect; PL=plural; REDUP=reduplication; SG=singular; TOP=topic marker.

² The morpheme *ai* appearing before the exclamatory marker *wa* in (2b) is referred to as the 'sentence final morpheme' in Dai & Xu (1992), and it is often inflected with number and person

agreements with the subject (sometimes even with the object), as indicated in the gloss 3SG(Subj)=third person singular agreement with subject. Interested readers are referred to Dai (2002) and Gu & Gu (2002) for detailed discussion of other peculiar properties of the sentence final morpheme.

³ It is worth mentioning that the connective *hte* 'and', *bai* 'also' or *hte bai* 'and also' can be optional inserted between the last two adjectives in all examples given in (15), as demonstrated in (i) below. Moreover, when the connective is present, the noun phrases no longer have a nested interpretation, in contrast with the examples in (15). Instead, each of the prenominal adjective modifies the head noun, i.e., they behave like adjectives appearing in coordination structure (e.g., 'the red, wonderful, and big car' in English).

- (i) a. gaba ai hkye ai dui ai (hte/bai/hte bai) myin ai namsi hkum mi
big MOD red MOD sweet MOD and/also/and also ripe MOD fruit Cl one
'one big red sweet and ripe fruit'
- b. myin ai dui ai hkye ai (hte/bai/hte bai) gaba ai namsi hkum mi
ripe MOD sweet MOD red MOD and/also/and also big MOD fruit Cl one
'one ripe sweet red and big fruit'
- c. dui ai hkye ai gaba ai (hte/bai/hte bai) myin ai namsi hkum mi
sweet MOD red MOD big MOD and/also/and also ripe MOD fruit Cl one
'one sweet red big and ripe fruit'
- d. hkye ai dui ai myin ai (hte/bai/hte bai) gaba ai namsi hkum mi
red MOD sweet MOD ripe MOD and/also/and also big MOD fruit Cl one
'one red sweet ripe and big fruit'

Furthermore, it is observed that when there are three [Adj + *ai*] forms preceding the noun, the first two [Adj + *ai*] forms need to be conjoined by *hte* 'and' while the second and third [Adj + *ai*] forms are conjoined by *bai* 'also', regardless of the ordering of the adjectives (see (ii) below). However, when there are only two prenominal [Adj + *ai*] forms, they must be conjoined with *hte* 'and', as shown in (iii):

- (ii) a. gaba ai *(hte) hkye ai *(bai) dui ai namsi hkum mi
big MOD and red MOD also sweet MOD fruit Cl one
(Lit.) 'one big and red also sweet fruit'
- b. dui ai *(hte) hkye ai *(bai) gaba ai namsi hkum mi
sweet MOD and red MOD also big MOD fruit Cl one
(Lit.) 'one sweet and red also big fruit'
- c. hkye ai *(hte) dui ai *(bai) gaba ai namsi hkum mi
red MOD and sweet MOD also big MOD fruit Cl one
(Lit.) 'one red and sweet also big fruit'
- d. hkye ai *(hte) gaba ai *(bai) dui ai namsi hkum mi
red MOD and big MOD also sweet MOD fruit Cl one
(Lit.) 'one red and big also sweet fruit'
- (iii) hkye ai *(hte) gaba ai namsi hkum mi
red MOD and big MOD fruit Cl one
(Lit.) 'one red and big fruit'

As pointed out by Jean-Roger Vergnaud (personal communication), it is a general property of coordination across languages that the presence of the connectives becomes more optional as the sequence lengthens, giving rise to something akin to a list. Further, he remarks that in a language like English or French, where the relevant point of departure is the shortest form with one *and* (*et*), this starts at three conjuncts, but in Jingpo, because the relevant form is the shortest one with a *bai* (see (ii-d) above), it starts at four. Some illustrative examples which show that English always allows random ordering of adjectives in coordination structures is given in (iv) (cf. (14a)):

- (iv) a. a wonderful, big, (and) red car b. a big, red, (and) wonderful car

One of the plausible means to capture the above facts is to assume that multiple prenominal adjectives always have a coordination structure, hence explaining why when the number of prenominal adjectives increases, the presence of the connective becomes optional in Jingpo (see the contrast of (i-ii) above). However, since there is an interpretational difference between multiple prenominal adjectives with and without connective, viz., the nested reading is no longer available when the connective is present, it seems problematic to suppose that the two types of noun phrases (i.e., with or without connective) are of the same structure.

⁴ Note that the data presented in this section (especially with regard to the distributions of the demonstrative) are slightly different from those in Cheung (2003a, b) but I strongly believe that the data presented in this paper are closer to the truth.

⁵ In addition to relative clauses, it has been noted in Schmitt (2000) that demonstratives and definite articles differ in *type* expressions (i), resultative expressions (ii), as pointed out in Schmitt (2000: 321).

- (i) a. John bought that type of house. b. *John bought the type of house.
 (ii) a. John painted the house that color. b. *John painted the house the color.

The above data further substantiate that demonstratives cannot be treated on a par with definite articles.

⁶ Note that the proposal that demonstrative is base-generated in Spec-LocP before raising to Spec-DP is supported by various evidence from Jingpo and other classifier languages such as Taiwanese and Mandarin. First, in both Jingpo and Mandarin, the locative elements are consistently derived from the demonstratives, as shown in (i-ii).

- (i) ndai/dai/htora + de → ndai de/dai de/htora de (Jingpo)
 this/that/that.upper level place here/there/there.upper level
 (ii) zhe/na + -r → zher/nar (Mandarin)
 this/that here/there

The fact that the demonstratives and locatives in Jingpo and Mandarin share the common stem may be due to the grammaticalization of demonstratives, since it has been suggested in the literature that demonstratives are often derived from adverbials such as locatives (see, for instance, Anderson & Keenan 1985, Greenberg 1985). If the demonstratives were indeed developed from locatives, our proposed structure in (32) has the merit of precisely capturing the grammaticalization path of demonstratives, given that it has often been argued that grammaticalization is an upward movement process (see, in particular, Simpson & Wu 2001).

Another important support for the current proposal comes from Taiwanese, since unlike Jingpo and Mandarin, the locative elements in Taiwanese can be used as demonstratives when followed by the modifying marker *e*, as demonstrated in (iii) (Audrey Li, personal communication), despite the fact that Taiwanese does possess demonstratives as shown in (iv):

- (iii) a. jia e tse b. hia e tse (Taiwanese)
 here MOD book there MOD book
 'these books' 'those books'
 (iv) a. jit saN bun tse b. hit saN bun tse
 this three CI book that three CI book
 'these three books' 'those three books'

Following our current analysis, it is feasible to develop a parametric account for the different properties of the locatives vs. those in Jingpo and Mandarin: for locatives in Taiwanese, they carry not only the [deictic] feature but also the [+def] feature, whereas those in Mandarin simply have the [deictic] feature (v). If this proposal is on the right track, it is expected that the locatives in Taiwanese can raise from the head LocP position to the head DP position in order to check off the [+def] feature, as shown in (vi) (setting aside the status of the modifying marker *e*):

- (v) [DP[LocP [Loc' zher][NumP liang][CIP ben][NP shu]]] (Mandarin)
 (vi) [DP [D' jiaɪ][LocP [Loc' tʃ][NP tse]]] (Taiwanese)

However, if one assumes that demonstratives are always base-generated in D or Spec-DP, the above facts would be left unaccounted for.

⁷ Note that the assumption that Jingpo noun phrases have a head-final structure does not amount to saying that the noun phrase structure of all OV languages must be head-final (see, for instance, Simpson, forthcoming, which shows that in many Southeast Asian languages, the headedness of the noun phrase usually does not coincide with the general headedness of the language).

Selected references

- Anderson, Stephan R. and Edward L. Keenan. 1985. 'Dexis', in Timothy Shopen, ed., *Language Typology and Syntactic Description III: Grammatical categories and the lexicon*, 259-308. Cambridge University Press.
- Bennett, Michael. 1978. 'Demonstratives and indexicals in Montague Grammars', *Synthese*, Vol. **39**: 1-80.
- Bernstein, Judy B. 1997. 'Demonstratives and reinforcers in Romance and Germanic Languages', *Lingua*, Vol. **102**: 87-113.
- Cheung, C.-H. Candice. 2003a. 'An investigation of the noun phrase structure of Kachin', in Dai Qing-Xia and Gu Yang, eds., *Modern linguistic theory and minority languages in China*, 149-169. Beijing: Minzu Chubanshe.
- Cheung, C.-H. Candice. 2003b. An investigation of the Jingpo nominal structure. MPhil. Thesis, Chinese University of Hong Kong.
- Chomsky, Noam. 1995. *The minimalist program*. Cambridge, Mass.: The MIT Press.
- Dai, Qing-Xia. 1998. *Research on Tibeto-Burman languages II*. Kunming, Yunnan: Yunnan Nationality Press.
- Dai, Qing-Xia and Gu Yang. 2003. 'On the grammatical category of Topic: A morphological analysis of topic in Jingpo', in Dai Qing-Xia and Gu Yang, eds., *Modern linguistic theory and minority languages in China*, 50-69. Beijing: Minzu Chubanshe.
- Dai, Qing-Xia and Xu Xi-Jian. 1992. *The grammar of Kachin*. Beijing: ZhongYang Minzu Xueyuan Chubanshe.
- Giusti, Giuliana. 1997. 'The categorial status of determiners', in Liliane Haegeman, ed., *The new comparative syntax*, 95-123. London: Longman
- Gu, Yang and Dai Qing-Xia. 2003. 'A structural analysis of the Jingpo [NP + A] constructions', in Dai Qing-Xia and Gu Yang, eds., *Modern linguistic theory and minority languages in China*, 70-99. Beijing: Minzu Chubanshe.
- Gu, Yang and Gu Gang. 2002. 'A further exploration on the sentence final morpheme *Ga* in Jingpo', paper presented in LSHK Annual Research Forum, University of Science and Technology, Hong Kong.
- Kayne, Richard S. 2004. 'Here and there', in C. Leclère, E. Laporte, M. Piot and M. Silberztein, eds., *Syntax, lexis and lexicon-grammar. Papers in honour of Maurice Gross*, 253-273. Amsterdam: John Benjamins.
- Li, Y.-H. Audrey. 1999. Plurality in a classifier language. *Journal of East Asian Linguistics*, Vol. **8**: 75-99.
- Liu, Lu. 1984. *Jingpozu Yuyan Jianzhi* [A brief introduction to the grammar of Kachin]. Beijing: Minzu Chubanshe.
- Schmitt, Cristina. 2000. 'Some consequences of the complement analysis of relative clauses, demonstratives and the wrong adjectives', in Artemis Alexiadou, Paul Law, Andre Meinunger, and Chris Wilder, eds., *The syntax of relative clauses*, 309-348. Amsterdam: John Benjamins.
- Simpson, Andrew and Xiu-Zhi Zoe Wu. 2001. 'The grammaticalization of formal nouns and nominalizers in Chinese, Japanese and Korean', in T E McAuley ed., *Language Change in East Asia*, 250-283. Curzon.
- Tang, C.-C. Jane. 1990. *Chinese phrase structure and the extended X-bar theory*. Doctoral dissertation, Cornell University.
- Xu Xi-Jian, Yue Xiang-Kun, Xiao Ja-Cheng and Dai Qing-Xia. 1983. *Jinghan Cidian* [Kachin-Chinese dictionary]. Yunnan: Yunnan Minzu Chubanshe.

Focus ‘-ka’ in Korean: A Base-Generated Approach

Cho, Sae-Youn
Kangwon National University

1. Issues

There are at least two conflicting views as the number of *-kas* found in Korean. Schütze (2001) claims that there are two *-kas* - a nominative case marker and a focus marker, which can be used to distinguish *-ka* in (1a) from that ‘stacked on top of’ the dative *-eykey* in (1b). Following Yoon’s (2001) argument, I define that the latter has [+foc] while the former, [+nom].

- (1) a. Georgia-ka pap-ul mek-ess-ta.
 -Nom rice-Acc ate-Decl ‘Georgia ate rice.’
 b. Georgia-eykey-ka ton-i manh-ta.
 -Dat-Nom money-Nom many-Decl ‘Georgia has much money.’

Contrary to Schütze’s claim, Yoon (2001) argues for one morpheme with two functions: [+nom] and [+nom, +foc]. Under Yoon’s (2001) analysis, the *-ka* in (1a) has the [+nom], while that in (1b) has the [+nom, +foc], which indicates a non-nominative subject. Though both of these analyses have merit, only Yoon’s analysis passes the Cleft Copula Construction (CC) test, where no element with [+nom] can appear immediately before the copula *-i*, as in (2).

- (2) a. *pap-ul mek-un kes-un Georgia-**ka**-i-ta.
 rice-Acc eat NM-Top -Nom-COP-Decl
 ‘It is Georgia who ate rice.’
- b. *ton-i manh-un kes-un Georgia-eykey-**ka**-i-ta
 money-Nom many- NM-Top -Dat-Nom-COP-Decl
 ‘It is Georgia who has a lot of money.’

In other words, both the *-ka* in (1a) and the one in (1b) cannot occur immediately in front of the copula, as illustrated in (2a) and (2b). This test demonstrates that Yoon’s analysis, where *-ka* can function as either [+nom] or [+nom, +foc], can account for why *-ka* cannot appear immediately before the copula, whereas Schütze’s analysis cannot explain why the focus marker *-ka* cannot occur in the CC as in (2b). Hence, Yoon’s analysis seems to be better able to describe the grammatical properties of *-ka* in Korean. However, it still cannot explain the full extent of the *-ka* phenomena; *-ka* in (3a) is attached to the locative PP ‘into the box’ and it can occur just before the copula as in (3b).

- (3) a. Georgia-ka sangca-ey-ta-**ka** ton-ul neh-ess-ta.
 -Nom box-at-Foc money-Nom put-Decl
 ‘Georgia put money into the box.’
- b. Georgia-ka ton-ul neh-un kes-un sangca-ey-ta-**ka**-i-ta
 -Nom money-Acc put- NM-Top box-at-Nom-Cop-Decl
 ‘It is the box which Georgia put the money into.’

In this paper, I assert that there is a third use of *-ka*, as in (4), whose function is to focus on the non-subject to which it is attached. So I argue that in Korean, *-ka* functions in three different ways, as shown in (4): *ka1* and *ka2* stand for [+nom, +/-foc] and [-nom, +foc], respectively.

(4) Morpheme	Function	Notation	Slot
-ka	[+nom, +/-foc]	ka1	Z-Lim
	[-nom, +foc]	ka2	before Delimiter (after (-ta))

Specifically, *ka1* with [+nom, +/-foc] can occur either in the normal subject position as in (1a) or in a so-called case-stacking position headed by existential predicates as in (1b). However, *ka2* of ‘(-ta)-ka’ with [-nom, +foc] in (3) may occur with predicates requiring various thematic roles such as Locative or Instrumental ones. To support my claim that there is a third use of *-ka* in which it functions as a pure focus marker, I will provide data on its working applications.

This paper is organized as follows: In section 2, the distributional behavior and basic properties of the focus *-ka* are introduced. Section 3 outlines how my base-generated approach can explain the properties and distributional behavior of the focus *-ka*. In section 4, I conclude by discussing the consequences of my hypothesis and the residual problems, which may require further study.

2. The Basic Properties of Ka2

2.1 Distributional behavior

As mentioned above, Yoon (2001) argues that *ka1* with [+nom, +/-foc] can occur in the normal subject position or in a case-stacking position headed by existential predicates. By contrast, we can distinguish between *ka2* with [-nom, +foc] and the other *-ka* usages by virtue of its occurrence with predicates requiring various thematic roles such as Locative or Instrumental roles, as illustrated in (5).

- (5) a. Georgia-ka siliel-ul wuyu-ey-**ta-ka2** pwue mekess-ta.
 -Nom cereal-Acc milk-Loc-Foc pour ate-Decl
 ‘Georgia ate some cereal with milk.’

- b. Georgia-ka Kim-ul khal-(lo)-(-ta)-ka2 cwuki-ess-ta.
 -Nom -Acc knife-Instr-Foc kill-Past-Decl
 ‘Georgia killed Kim with a knife.’

In (5a), *ka2* is attached to the locative PP subcategorized by the predicate, *pwue mekess-ta*, and can also be attached to the instrumental PP as in (5b). In the Kyungsang dialect, the instrumental PP, *khal-lo-ta-ka*, can be used as either *khal-lo-ka2* or *khal-ka2*. This may challenge the traditional view held by, amongst others, Shim et al (1999) that *-ta* is a shortened form of *-taka*. In addition to Locative and Instrumental PP, *ka2* can occur with Commutative ‘-*hako*’ or Comparator ‘-*pota*’ as in (6).

- (6) a. ne-pota-ka2-(nun) nay-ka (te) nas-ta.
 you-than-Foc I-Nom (more) better
 ‘I am better than you.’
 b. i os-i ne-hako-ka2 cal mac-nun-ta.
 this dress-Nom you-with-Foc well match-Decl
 ‘This dress matches with you well.’

Furthermore, *ka2* can also be attached to Adverbial Negative Polarity Items (Ad-NPI) such as *totayche* (‘on earth’) and *tomwuci* (‘in the least’) as in (7).

- (7) Georgia-ka tomwuci/totayche(-ka2/*?-lul) pap-ul an mek-e.
 -Nom in the least/on earth (-Foc/-Acc) rice-Acc not eat-Decl
 ‘Georgia won’t eat any meal at all.’

The aforementioned Ad-NPIs, however, cannot co-occur with the morpheme *-lul*, which seems to suggest that the occurrence of *ka2* is difficult to explain by

means of the foregoing analyses. Specifically, since those analyses claim that *-ka* and *-lul* can be attached to durative or frequency adverbs depending on the agentivity or stativity of the predicate, it is difficult to explain how the adverbs occur only with *-ka*. In sum, *ka2* can co-occur with various elements headed by or selected by various predicates, but yet it has some form of complementary relationship with the other *kas*.

2.2 The multiple occurrence of *-ka* in a word

The second property of *ka2* is that, even in a CC sentence, it is only when *ka2* is present that more than one ‘*-ka*’ can be attached to a nominal element. For clarity, we begin by introducing Copula construction in Korean. The Copula can be classified in two different ways: positive copula ‘*-i*’ and negative copula ‘*-ani*’. One of the characteristics of Copula construction is that a complement with case-markers such as *-ka* can occur with negative copula (NC), but not with positive copula (PC), as demonstrated in (8).

- (8) a. *Georgia-ka kyoswu-**ka** i-ta.
 -Nom professor-Nom PC-Decl ‘Georgia is a professor.’
 b. Georgia-ka kyoswu-(**ka**) ani-ta.
 -Nom professor-(Nom) NC-Decl ‘Georgia is not a professor.’

Given this, it is not difficult to find the data which illustrates the presence of two *-kas* as in (9). It is worthwhile noting that it is only when *ka2* is involved that more than one ‘*-ka*’ can be attached to a nominal element in a CC sentence.

- (9) a. Georgia-ka siliel-ul pwue mek-un kes-un mwul-ey-ta-**ka2-ka1** ani-ko
 -Nom cereal-Acc put eat NM-Top water-at-Foc-Nom NC

wuyu-ey-ta-**ka2** i-ta
 milk-Loc-Foc PC-Decl

‘Georgia ate cereal not with water but with milk.’

b. *ton-i manh-un kes-un Georgia-eykey-**ka1-(ka1)** i/ani-ta
 money-Nom many- NM-Top -Dat-?-? PC/NC-Decl

‘It is Georgia who has a lot of money.’

The fact that two *kas* can be acceptably attached to the locative PP in (9a) shows that if *-ka* functions only as [+nom, +/-foc], it is difficult, under Yoon’s analysis, to account for why (9a) is acceptable and (9b) is not. On the other hand, if *ka2* is a third use of *-ka*, i.e. [-nom, +foc], then the first *-ka* can be regarded as *ka2* and the second, as *ka1*. Moreover, though the complement immediately before the PC should not have a nominative case, the phrase *wuyu-ey-ta-ka* in (9a) has *-ka*, and is still acceptable. While this would be a puzzle under Yoon’s analysis, it is easily supported by my hypothesis.

2.3 The interaction of locative ‘-ey’ and dative ‘-eykey’ with *ka2* and ‘-lul’

It is interesting to note that *ka2* can be attached to the NP assigned a Locative by verbs such as ‘deposit’ while the morpheme ‘-lul’ can be attached to the optional complement NP assigned a Directive by verbs such as ‘go’, as shown in (10).

(10) a. Georgia-ka ton-ul unhayng-ey-ta-**ka2**/(***-lul**) mathki-ess-ta.
 -Nom money-Acc bank-Loc-Foc/(***-Acc**) deposit-Past-Decl

‘Georgia deposited her money to the bank.’

b. Georgia-ka hakkyo-ey-**lul**/(***-ta-ka2**) ka-ss-ta.
 -Nom school-Dire-Acc/(-Foc) go-Past-Decl

‘Georgia went to school.’

In addition, *ka2* tends to be attached to the object NP with a more Locative –like *-ey/-eykey* which is subcategorized by ditransitive verbs such as ‘give’, but both *ka2* and *-lul* cannot be attached to the PP with a Source Role subcategorized by ‘receive’, as shown in (11).

- (11) a. Georgia-ka ton-ul yanglowen-ey-ta-**ka2**/(??-**lul**) cwu-ess-ta.
 -Nom money-Acc a home for the aged-Loc-Foc/(??-Acc) give-Past-D
 ‘Georgia donated her money to a home for the aged.’
- b. Georgia-ka ton-ul Tom-eykey-*(ta-**ka2**)/(*-**lul**) pat-ass-ta.
 -Nom money-Acc -Dat-*Foc/(*-Acc) receive-Past-Decl
 ‘Georgia received her money from Tom.’

The aforementioned observations lead us to conclude that if a Dative case is assigned to an element due to Goal or Source so that *-ey/-eykey* can be attached to it, *ka2* cannot co-occur with it. Rather, *ka2* can be freely attached to the element with a Locative. It appears that the occurrence of *ka2* and *-lul* is not influenced by the agentivity or stativity of the predicate. Though I still need to determine which thematic role corresponds to which case particles, I can now classify *-ka*, *-lul*, *ey/eykey* as follows:

(12)	-ka	ka1	[+nom, +/-foc]
		ka2	[-nom, +foc]
	-lul	lul	[+acc, +/-foc]
	ey/eykey	dat & loc	[+dat] & [+loc]

2.4 The status of *ka2* in slot assignments of nominal affixes

If *ka2* functions differently from the other *kas*, then the question of where the morpheme *ka2* can rightfully appear must be answered. To do so, I propose that

ka2 can occur between the Conjunctives and the X-Lim in the sense of the Slot Assignments of Nominal Affixes as suggested by Cho & Sells (1995) and as illustrated in (13).

(13) Slot Assignments of Nominal Affixes: (C&S 1995:118)

Postpositions	Conjunctives	X-Lim	Z-Lim
<i>Eykey(se)</i> ‘dative’ <i>hanthey(se)</i> ‘dative’ <i>ey(se)</i> ‘locative’ <i>ey, (u)lo</i> ‘directive’ <i>kkaci</i> ‘goal’ <i>hako, (k)wa</i> ‘comit’ <i>(u)lo</i> ‘instrumental’	<i>hako, (k)wa</i> ‘conjunctor’ <i>pota</i> ‘comparator’ <i>(i)na</i> ‘disjunctor’ ‘something like’ <i>pwuthe</i> ‘from’ <i>chelem</i> ‘like’	<i>man</i> ‘only’ <i>kkaci</i> ‘even’ <i>mace</i> ‘even’ <i>cocha</i> ‘even’ <i>pakkey</i> ‘only’	<i>(n)un</i> ‘topic/focus’ <i>to</i> ‘also’ <i>(i)lato</i> ‘even’ <i>i/ka</i> ‘nominative’ <i>(l)ul</i> ‘accusative’ <i>uy</i> ‘genitive’ <i>i-</i> ‘copula’

The morpheme *ka2* can appear immediately after Postpositions such as *-ey*, *-hako*, and *-lo* or Conjunctives such as *-pota* as shown in (5-6). It cannot, however, occur after X-Lim or Z-Lim, as in (14). Specifically, if *-man* in X-Lim or *-i* in Z-Lim precedes *ka2*, the string should be ill-formed.

(5) a. Georgia-ka siliel-ul wuyu-ey-**ta-ka2** pwue mekess-ta.

-Nom cereal-Acc milk-Loc-Foc pour ate-Decl

‘Georgia ate some cereal with milk.’

b. Georgia-ka Kim-ul khal-(lo)-**(-ta)-ka2** cwuki-ess-ta.

-Nom -Acc knife-Instr-Foc kill-Past-Decl

‘Georgia killed Kim with a knife.’

(6) a. ne-pota-**ka2**-(nun) nay-ka (te) nas-ta.

you-than-Foc I-Nom (more) better

‘I am better than you.’

b. i os-i ne-hako-ka2 cal mac-nun-ta.

this dress-Nom you-with-Foc well match-Decl

‘This dress matches with you well.’

(14) ... khal- lo- ta- ka- **man** -i

knife- Instr- Foc- ‘only’(X-Lim) – ‘Nom’(Z-Lim)

‘... only with the knife...’

Though the validity of the templatic analysis of inflection affixes is still controversial, I suggest that *ka2* can occur between the Conjunctives and the X-Lim slot in the Slot Assignments of Nominal Affixes as in (13).

3. A Base-Generated Approach

I have, so far, reviewed the various properties of *ka2* with the aid of the above empirical data. This review can be summarized as follows:

(15) Properties of ka2

1. *Ka2* can be attached to the PP with Locative, Instrumental, Commutative and Comparator.
2. *Ka2* may be attached to the Ad-NPIs such as *tomwuci*.
3. *Ka* can occur twice in a word only when *ka2* is involved.
4. The occurrence of *ka2* cannot be predicted by the agentivity of the predicate.
5. *Ka2* can be generated between Postpositions and X-Lim.

To accommodate the properties of *ka2* as well as the other *kas* and *ey/eykey*, I provide the following case system for Korean:

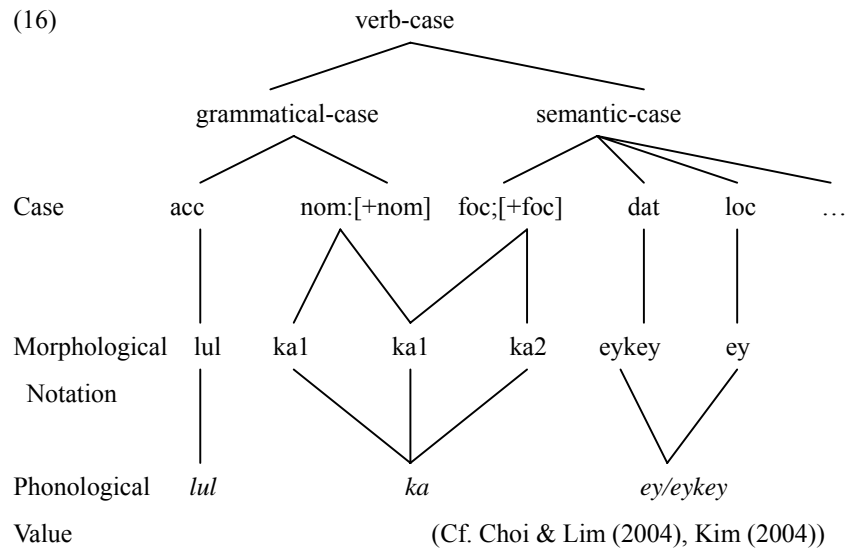

This case system specifies that *ka1* and *ka2* must morphologically denote [+nom,+/-foc], and [-nom, +foc], respectively. If it is assumed that each thematic role should be mapped to a g-case and/or s-case(s) in the lexicon in terms of a linking theory, the set of appropriate phonological realization for a predicate can be predicted by Phonological functions in HPSG.

For clarity, I have used the data (1a-b) to demonstrate how this system works for the distribution of *-ka*. As mentioned above, *ka1* appears in a normal subject position in (1a) or in a non-nominative subject position in (1b). To account for this, this system can predict which *ka* can appear in which position in a sentence on the basis of the lexical information given in (17).

- (17) a. *mek-* ‘eat’: [ARG-ST <NP[G-CASE *ka1*], NP[G-CASE *lul*]>]
 b. *manh-* ‘be abundant’: [ARG-ST <PP[S-CASE *ey/eykey*], NP
 [G-CASE *ka1*]>]

It is important to note that the value of S(ematic)-Case or G(rammatical)-Case in the elements of ARG-ST list in (17) does not have to be realized in Phonological form via Phonological functions. This will explain why Korean particles are used on an optional basis. I have assumed that the occurrence of *ka2* can be regulated by the linking theory mapping a thematic role to case. However, it is clear that *ka2* cannot be easily accounted for under the previous analyses.

4. Conclusions

Though Yoon (2001) provides a neat explanation for the case stacking phenomena, the distributional behavior of *ka2* would be puzzling. The idiosyncratic behaviors of *ka2*, however, are explained by my contention that *ka2* can function as [-nom, +foc]. Consequently, in conjunction with Yoon's analysis, my analysis enables us to account for *-ka*-related Case phenomena in Korean.

My work on this topic can best be described as an on-going project. Although I am not yet in a position to provide a complete explanation of the case system in Korean, I feel that I am able to make a claim of some significance in support of a third use of *ka* in Korean. I intend to pursue further such issues as how to develop a linking theory mapping a thematic role to appropriate case values.

End Notes

This work was supported by the Korea Research Foundation (Grant Number 2004—041-A00193). I am grateful to James Yoon, Peter Sells, Yongkyoon No, and Incheol Choi for their critical comments.

References

Cho, Y.-M. and P. Sells. 1995. "A lexical account of inflectional suffixes in Korean",

- JEAL* 4: 119-174.
- Choi, I.-C. and Lim, K.-S. 2004. "External Arguments and Case Assignment in Korean", Ms.
- Kim, J.-B. 2004. "Korean Case System and Issues in the Computational Implementation", Ms.
- Pollard, C. and I. Sag. 1994. *Head-Driven Phrase Structure Grammar*. Chicago: University of Chicago.
- Schütze, C. 2001. "On Korean 'case stacking': the varied functions of the particles ka and lul", *The Linguistic Review* 18: 198-232.
- Shim J.-K., et al. 1999. *Phyocwun Kwuke Taysacen*. Kwuklip Kwuke Yeonkwuven. DooSan Dong-A Publishing Company.
- Yoon, James H-S. 2001. Non-nominative (Major) Subjects in Korean. To appear in *Non-nominative Subject*, Berlin: Mouton de Gruyter.

Sae-Youn Cho

Kangwon National University

sycho@kangwon.ac.kr

Is Impersonal *si* in Italian Definite or Indefinite?

Roberta D'Alessandro
University of Cambridge

1. Introduction

Impersonal *si* constructions (ISCs) introduce an underspecified, generic subject in a clause:

- (1) In Turchia *si* mangia la cioccolata
in Turkey *si* eats the chocolate
'In Turkey people eat chocolate'

The interpretation of ISC is not univocal; in some contexts, ISCs may be interpreted inclusively, like in (2):

- (2) *Si* è arrivati tardi ieri
si is-3RD SG arrived late yesterday
'We arrived late yesterday'

In (2), the reference set of *si* includes the speaker (inclusive reading).

Impersonal *si* has often been analyzed as an indefinite (Chierchia 1995, Manzini 1988), because of the alternation between a generic (1) and an existential reading (2). Upon a closer look, however, one realizes that the existential reading in (2) is further specified for inclusiveness, i.e. there is further specification for the speaker to be included among the referents of *si* which is not usually present in existential clauses. In other words, *si* is interpreted as 'we'.

In this paper, I propose that impersonal *si* is not an indefinite but rather a definite pronoun with an underspecified person feature.

Moreover, I show that the inclusive reading arises when the event expressed by the verb is bounded (Iatridou *et al.*, 2003).

The paper is structured as follows: First, I propose that impersonal pronouns like *si* have an additional set of features, the σ -set. Then, in section 2, I show that the inclusive reading is triggered by inclusiveness. In section 3, I show how boundedness and the σ -set interact for the specification of the reference set of *si* as inclusive. Last, section 4 contains my conclusions.

1.1. Syntactic and semantic features of *si*

Some pronouns may show a mismatch between their syntactic person and their referent (reference set). This happens more often when the pronouns are used impersonally, like the 2nd person *pro* ('you') in (3):

- (3) Se *pro* vuoi essere ricco,
 if pro-2ND SG want-2ND SG be rich
- pro* devi lavorare sodo
 pro-2ND SG must-2ND SG work hard
 'If one wishes to be rich, one must work hard'

In (3), *pro* may be interpreted as having a generic referent, i.e. 'one'. There is a mismatch between *pro*'s syntactic 2nd singular person and its generic reference ('you' vs. 'one'). *Pro* is not interpreted (only) as 'you', but as 'one', which is not 2nd singular and does not correspond to the Addressee.

Building on Wechsler & Zlatić (2001), I propose the existence of two different feature sets on pronouns: the 'traditional' φ -set, which encodes the syntactic features of pronouns, and the σ -set, which encodes syntactically the information about the actual participants in the event¹. The feature bundle of *pro* in (3) is presented in (4):

(4)

	φ features	σ - features
Number	singular	SINGULAR
Gender	no gender	MASC/FEM ²
Person	2nd pers	GENERIC

Syntactic agreement takes place through Agree, which targets the set. Agree is a syntactic operation aimed at eliminating uninterpretable features. This operation takes place when a Match relation is established between unvalued features on a probe and valued features on a goal (Chomsky 2000).

Semantic-pragmatic agreement takes place through Concord, which targets the σ -set. Concord is the same operation as Agree, but it targets the σ -set.

1.1.1. The feature bundle of impersonal *si*

The feature bundle of impersonal *si* is not clear-cut, as *si* doesn't show inflection morphologically. According to Chierchia (1995), impersonal *si* is semantically plural, as it always identifies a group of humans and it may never refer to a single person, except in pragmatically marked contexts:

- (5) Si canta e si balla
 si sings and si dances
 'People sing and dance' [D'Alessandro (2004:46)]

Si in (5) may never refer to a single person. It is, therefore, semantically plural. Syntactically, *si* has no number³.

Moreover, I assume that impersonal *si* is syntactically 3rd person, as it always triggers 3rd person agreement on the verb. Semantically, *si* has an underspecified σ -person feature. Last, *si* has no syntactic gender but has a disjoint σ -gender feature, i.e. it may both refer to males or females depending on its referents. I propose the following feature bundle for impersonal *si*:

(6)

	φ features	σ - features
Number	no	PLURAL
Gender	no gender	MASC/FEM
Person	3rd	UNDERSPECIFIED
Animacy	no	HUMAN

The inclusive/generic interpretation is obtained by specifying the σ -person feature of impersonal *si*.

In what follows, I first show what causes this specification and then propose a mechanism for the specification of the σ -person feature.

2. Boundedness and inclusive readings

As shown in (1)-(2), the interpretation of impersonal *si* is not univocal. In some contexts, *si* may be interpreted inclusively, i.e. as including the speaker among the participants in the event described by the verb. According to Cinque (1988, 1995), inclusiveness is related to specific time reference. Cinque provides several examples that show that specific time reference triggers inclusiveness, like (7):

- (7) *Amici! Un minuto fa si è stati abbandonati a se stessi
 friends one minute ago si is been abandoned to oneself
 'My friends! One minute ago we were left to oneself'
 [Cinque (1995:159-160)]

In (7), *si* is incompatible with a 3rd person arbitrary element like *se stessi*. This is a characteristic of inclusive *si*⁴. According to Cinque, *si* is inclusive in (7) because of the specific time reference *un minuto fa* ('one minute ago').

Specific time reference, however, is not the only trigger for inclusiveness. D'Alessandro and Alexiadou (2002) show that inclusiveness also originates from perfective aspect. They propose the following couple of examples:

- (8) In quel ristorante si mangiava bene
 in that restaurant si ate-IMPF well
 'One used to eat well in that restaurant' (GEN)
 (9) In quel ristorante si è mangiato bene
 in that restaurant si is eaten-PF well
 'We ate well in that restaurant' (INCL)
 [D'Alessandro and Alexiadou (2002: 35)]

In (8), the occurrence of imperfective aspect results in a generic reading of *si*. In (9), the use of perfective results in an inclusive reading of *si*.

Perfective is undoubtedly responsible for the inclusive reading of *si*. However, as observed by Adriana Belletti (p.c.), the following perfective sentence has a generic (not an inclusive) reading:

- (10) In quel ristorante *si* è sempre mangiato bene
 in that restaurant *si* is always eaten-PERF well
 ‘One could always eat well in that restaurant’ (GEN)

The sentence in (10) is perfective. Nevertheless, the reading of *si* is generic.

(10) shows that perfectivity is not the only trigger for inclusiveness. I wish to propose that inclusiveness is triggered by the temporal boundedness of the event: if an event is bounded (Iatridou *et al.*, 2003), the reading of *si* is inclusive. If the event is unbounded, inclusiveness cannot arise.

If this generalization holds, then inclusiveness cannot arise whenever we are in presence of an unbounded event. This is in fact the case, as becomes evident when we examine contexts in which the prototypical unbounded tenses appear: present (habitual) and imperfective.

As shown above, in (8), imperfective aspect usually correlates with a generic reading. As for the present tense, according to Smith and Erbaugh (2002), the following generalization holds:

- (11) The Bounded Event Constraint: Bounded events are not located in
 the Present [Smith and Erbaugh (2002:4)]

Thus, events in the present tense are unbounded. This means that impersonal *si* in the present tense should never be inclusive.

Let us consider a clearly inclusive sentence, like (2), here repeated in (12):

- (12) *Si* è arrivati tardi ieri
si is-3RD SG arrived-PF late yesterday
 ‘We arrived late yesterday’

If we turn (12) into the present tense, the inclusive reading disappears:

- (13) *Si* arriva tardi in stazione (se *si* prende la metro)
si arrives-PRES late in station if *si* takes the metro
 ‘One arrives late at the station (if one takes the underground)’

In (13), the present tense turns the sentence into a generic one. The generalization according to which unboundedness generates genericity holds. It is however worth observing that not every kind of present tense disallows inclusiveness. Let us consider the sentence in (14):

- (14) Quando si mangia?
 when si eats-3RD SG PRES
 ‘When are we going to eat?’

In (14), *si* is interpreted inclusively despite the present tense. This is very likely due to the fact that this present tense has a future, punctual meaning, and is therefore bounded.

That unbounded events do not license an inclusive reading is also shown from the fact that introducing adverbs that eliminate event boundaries results in the disappearing of inclusiveness. We have an example of this kind in (10), here repeated as (15):

- (15) In quel ristorante si è sempre mangiato bene
 in that restaurant si is always eaten-PERF well
 ‘One could always eat well in that restaurant’ (GEN)

Adverbs like *always* eliminate the event boundaries (Iatridou *et al.*, 2003). Therefore, when *always* is present in the clause, the inclusive reading cannot arise.

In sum, inclusiveness is triggered by event boundedness. In what follows, I propose a syntactic approach to correlate boundedness and the inclusive reading of impersonal *si*.

3. Is *Si* a Variable?

According to Chierchia (1995), impersonal *si* in Italian behaves, at least partially, as an indefinite. A general definition of indefinites is provided by Kamp (1981) and Heim (1982). Kamp and Heim state that:

- [i.] Indefinites have no quantificational force on their own. They are, in this respect, like free variables.
- [ii] The quantificational force of indefinites is determined by the first available binder, that is, the lowest c-commanding quantifying determiner (*every, no, most, ...*) or adverb of quantification (*always, usually*). These quantifying elements are *unselective*. They bind all free variables in their domain.
- [iii.] A binder Q sets up a tripartite structure of the form Q [A][B], where A is the *restriction* of the binder and B its *nuclear scope*.

Chierchia (1995) suggests that impersonal *si* introduces a variable that ranges over a group of humans. The generic reading is obtained by means of a generic operator that binds the variable introduced by *si*. When an existential operator is present in the clause, impersonal *si* receives an existential reading. The inclusive reading is however not addressed by Chierchia (1995). Building on Chierchia's insights, I would like to move a step further and address the problem of inclusiveness. I wish to propose that *si* is a pronoun, not an indefinite, as is shown from the fact that it can receive an inclusive interpretation, i.e. an existential interpretation further specified for inclusiveness. The specification for inclusiveness takes place by valuing *si*'s underspecified σ -person feature, as I show in 3.2. and 3.3..

3.1. [bounded] and [unbounded] features

We have already seen, in 2., that the inclusive reading depends on event boundedness. Iatridou *et al.* (2003) propose that there exist a syntactico-semantic feature [unbounded], which is realized by progressive and imperfective morphology, and a syntactico-semantic feature [bounded], which is realized by perfective morphology. Such features are present on the aspectual head. According to Giorgi and Pianesi (2004), however, postulating two distinct features for boundedness and unboundedness is not necessary⁵. They claim that 'the morphological distinction between perfective and imperfective verbal forms does not correspond to two distinct aspectual (notional) values; rather, it corresponds to the presence vs. absence of the unique aspectual value of terminativity'.

Building on these analyses, I wish to propose that when an event is unbounded, an [unbounded] feature is present on the aspectual head. When the event is not unbounded, i.e. when the event is bounded, no feature is present on the aspectual head.

The structure I wish to adopt is the following:

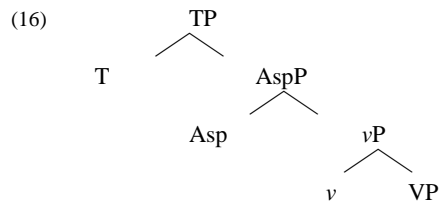

When the event is unbounded, the AspP will host an [unbounded] feature, as in (17):

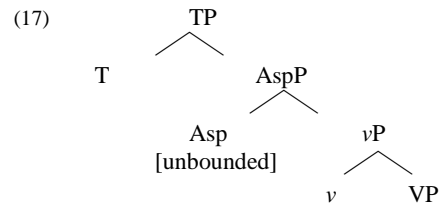

AspP is the projection that conveys aspectual information. We have seen in 2. that imperfective aspect correlates with unboundedness. Therefore, postulating the existence of an [unbounded] feature on the aspectual head when the event is unbounded is not hazardous.

3.2. The generic interpretation

Let us consider an unbounded/generic clause once again:

- (18) In Turchia *si* mangia la cioccolata
 in Turkey *si* eats the chocolate
 'In Turkey people eat chocolate'

We have seen that, when the event is unbounded, the interpretation of *si* is generic. Syntactically, this suggests that when the interpretation of impersonal *si* is generic, as in (18), the unbounded feature on AspP values the σ -person feature on *si*.

Following D'Alessandro (2004), I assume that impersonal *si* is merged in the specifier of EP (event phrase). In order for the sentence to be interpretable, impersonal *si* needs to have its σ -features valued. In other words, the referents set of *si* needs to be identified.

According to Bianchi (2003), in fact, it is necessary to anchor the lexical (i.e. syntactic) person feature of pronouns to a specific speech event/situation in order for the interpretation of the pronoun to be possible. This happens because the person is intrinsically deictic, and it needs to be linked to the speech act for its interpretation. Along the same lines, Sigurðsson (2002) explores the idea that the person feature establishes the relationship between the participants of the speech event, encoded in the Speech phrase, and the participants of the event,

i.e. the verb's arguments. Bianchi (2003) and Sigurðsson (2002) move further and propose that person checking takes place in the clause rather than Case checking. Moreover, they assume that the speech event/situation is syntactically encoded in one or more functional heads in the clause.

In our terms, we can say that the σ -features of pronouns need to be valued in order for pronouns to be correctly interpreted. This valuation takes place through Concord. We have seen in (5) that *si* has a pragmatic-semantic underspecified σ -feature. The σ -feature needs to be valued in order for the pronoun to be interpreted.

If the pronoun is interpreted generically, its σ -person feature valuation takes place between the [unbounded] feature on the AspP and the underspecified σ -person feature on *si*, as shown in (19):

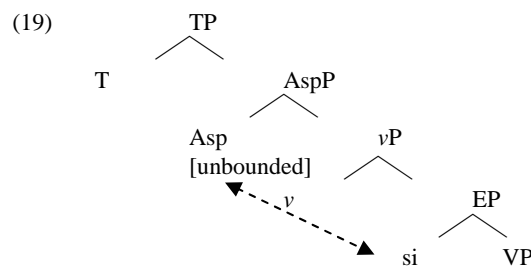

The [unbounded] feature values the σ -person feature on *si*, which results in a generic reading.

When the event is bounded, the valuation of the σ -person feature of *si* takes place via anchoring to the Speech Act P, as I show in the next section.

3.3. The inclusive interpretation of impersonal *si*

In 3.2., Bianchi's and Sigurðsson's proposals were outlined, according to which person checking is necessary in order for pronouns to be interpretable. I have just proposed that the person feature on impersonal *si* receives its 'generic' interpretation by being valued by the [unbounded] feature on the AspP when the event is unbounded.

When the event is bounded, the [unbounded] feature is not present on the AspP. The person feature of impersonal *si* needs to be valued by

anchoring itself to the Speech ActP. Let us consider the inclusive sentence in (2), here repeated as (20):

- (20) Si è arrivati tardi ieri
 si is-3RD SG arrived late yesterday
 ‘We arrived late yesterday’

The derivation of (20) is exemplified in the tree diagram in (21):

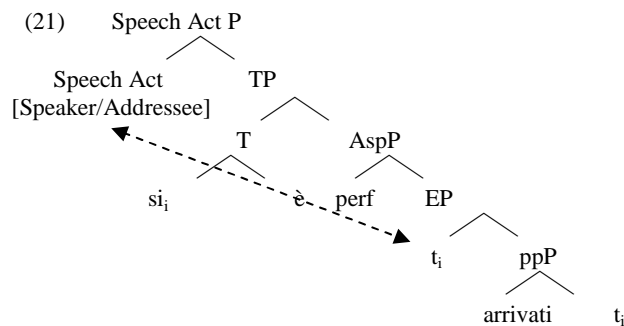

The σ -person feature of impersonal *si* receives its value through Concord with the Speech ActP. The Speech Act P encodes syntactically the information about the actual participants in the speech event (Bianchi 2003, Sigurðsson 2002). In particular, the Speech Act P includes information about the Speaker. This means that the σ -feature on impersonal *si* is valued as ‘Speaker’. If the σ -number feature has the value ‘plural’ and the σ -person feature has the value ‘Speaker’, the inclusive interpretation arises without further ado.

4. Conclusions

Impersonal *si* has several interpretations. It may be interpreted generically, (English ‘one’), or existentially (English ‘somebody’). It also has an inclusive interpretation (English ‘we’). This paper focuses on the inclusive reading of impersonal *si*. It is shown that inclusiveness is not triggered only by specific time reference (Cinque 1988) or by imperfective aspect (D’Alessandro and Alexiadou 2002), but that it is triggered by event boundedness. Whenever the event is bounded, the inclusive reading arises. When the event boundaries are eliminated, inclusiveness disappears.

Moreover, following D'Alessandro (2004), it has been proposed that pronouns have an additional feature set, the σ -set, which encodes syntactically the pragmatic information about the actual participants in the speech event. The σ -person feature of *si* is underspecified, and it needs to be valued in order for the pronoun to be interpretable. The valuation of the person feature takes place through Concord with the [unbounded] feature that is present on the AspP if the event is unbounded. If the event is bounded, the valuation of the person feature of *si* takes place through Concord with the Speech Act P, which has the value Speaker. If the σ -person feature on *si* is valued as Speaker, the inclusive reading arises.

References

- Bianchi, Valentina. 2003. 'On the syntax of personal arguments', ms. University of Siena.
- Chierchia, Gennaro. 1995. 'The variability of impersonal subjects', in Bach, E., E. Jelinek, A. Kratzer and B. Partee (eds.), *Quantification in Natural Languages*, Kluwer: Dordrecht, pp. 107-143.
- Chomsky, Noam. 1999. *Derivation by Phase*. MIT Occasional Papers in Linguistics **18**. Cambridge: MIT Press.
- Cinque, Guglielmo. 1988. 'On *si* constructions and the theory of *arb*', *Linguistic Inquiry* **19**. 521-582.
- Cinque, Guglielmo. 1995. *Italian syntax and Universal Grammar*, Cambridge: Cambridge University Press.
- D'Alessandro, Roberta and Artemis Alexiadou. 2002. 'Inclusive and exclusive impersonal pronouns: a feature-geometrical analysis', *Rivista di Grammatica Generativa* **27**. 31-44.
- D'Alessandro, Roberta. 2004. *Impersonal si constructions. Agreement and interpretation*. Doctoral diss. University of Stuttgart.
- Giorgi, Alessandra and Fabio Pianesi. 2004. 'On the Speaker's and the Subject's Temporal Representation: The Case of the Italian Imperfect', in Guéron, J. and J. Lecarme, *The Syntax of Time*. Cambridge: MIT Press.
- Heim, Irene. 1982. *The semantics of definite and indefinite noun phrases*, PhD. diss, University of Massachusetts at Amherst.
- Iatridou, Sabine, Elena Anagnostopoulou and Roumyana Pancheva. 2003. 'Observations about the form and meaning of the Perfect, in Alexiadou, A., M. Rathert and A. von Stechow (eds), *Perfect Explorations*. Berlin: Mouton de Gruyter.
- Kamp. Hans. 1981. 'A theory of truth and discourse representation', in Groenendijk, J., T. Janssen & M. Stokhof (eds.), *Formal methods in the study of language*. Amsterdam: Mathematical center. 277-322.
- Kratzer, Angelika. 1995. 'Impersonal pronouns and passive meaning', ms.

- University of Massachusetts at Amherst.
- Kratzer, Angelika. 2000. 'German impersonal pronouns and logophoricity', paper presented at the *Generic pronouns and logophoricity* conference, São Paulo.
- Sigurðsson, Halldór. 2002. 'Non-nominative subjects in Icelandic', ms. University of Lund.
- Smith, Carlota and Mary Erbaugh. 2002. 'Temporal Interpretation in Mandarin Chinese', ms., University of Texas and University of Oregon.
- Wechsler, Stephen and Larisa Zlatić. 2001. A theory of Agreement and its Application to Serbo-Croatian'. *Language* 76. 4: 799-832.

Roberta D'Alessandro
University of Cambridge
roberta.dalessandro@gmail.com

¹ The reader is referred to D'Alessandro 2004 for a detailed description of the ϕ -set and σ -set.

² The σ -gender feature is both masculine and feminine. It is a **disjoint** feature, which encodes each of the two values depending on the referent. The reader is addressed to D'Alessandro (2004) for a detailed description of disjoint features.

³ That *si* has no number is extensively argued for in D'Alessandro (2004). Discussing *si*'s syntactic features would take us too far afield, and is not relevant here. I therefore assume that *si* has no syntactic number and address the reader to D'Alessandro (2004) for a detailed discussion of *si*'s syntactic features.

⁴ Some diagnostics have been proposed in order to identify the inclusive reading of impersonal pronouns. The reader is referred to Cinque (1988) and Kratzer (1995, 2000) for a complete list of such diagnostics.

⁵ Giorgi & Pianesi (2004) talk about 'terminativity', not about event boundedness. For the aims of the present discussion, however, the two terms may be considered to overlap.

Event-Path Homomorphism and the Accompanied-Motion Reading in Motion Causatives

Raffaella Folli & Heidi Harley

University of Cambridge & University of Arizona

1. Introduction: Structures and Meanings of Motion Verbs

English motion verbs occur in a number of different frames. They can be intransitive (with or without adjuncts, such as a locative PP), intransitive with a Goal PP, or transitive (causative) with a Goal PP. This last point has been discussed at length in the literature, and the connection between the availability of the causative and the presence of the goal PP has been considered strong evidence for the existence of tight connection between telicity and transitivity.

- (1) a. Mary walked (in the house)
b. Mary walked to the house.
c. Mary walked Bill *(to the house).

Nevertheless a number of properties restrict the formation of such alternations with a motion verb.

First, not all verbs are compatible with a causative form as shown by the verb *to shudder* in the example below:

- (2) a. The train shuddered into the station.
b. *Bill shuddered the shopping cart across the parking lot.

Second, the formation of a causative frame with motion verbs is subject in certain cases to an extra requirement which we will refer to as the accompanied-motion requirement:

- (3) a. John walked Bill to the house.
b. Mary whistled the dog to the house

In (3)a John's walking has to last all the way to the house, while in (3)b such requirement is not present, as the whistling event can entirely precede the travel.

Third, English verbs compatible with the (c) structure can differ with respect to whether or not they require their subject to be intentional:

- (4) a. The tide rolled the log up the beach.
b. #The wind walked the dog into the house.

Finally, with verbs which don't require their subject to be intentional in the (c) structure, the accompanied-motion requirement is not present and so in (5) *Bill* doesn't have to go along with *the ball*.

(5) Bill rolled the ball to the baby

In this paper, we will investigate the relationships between the meanings of the structures and the semantic content of the verbs with the aim of explaining the above constellation of facts and in particular the accompanied-motion requirement. Developing arguments put forward in Folli and Harley (2002), we will argue that the availability of the causative form in (1)c is tightly related the presence of a secondary predicate allowing the projection of a SC and not to the telicity of the PP.

2. Goal-of-Motion Requires Small Clause, not Telicity

Following Hale and Keyser (1993) and Hoekstra and Mulder (1990) (among others), we assume that (1)a-c have the following structures¹:

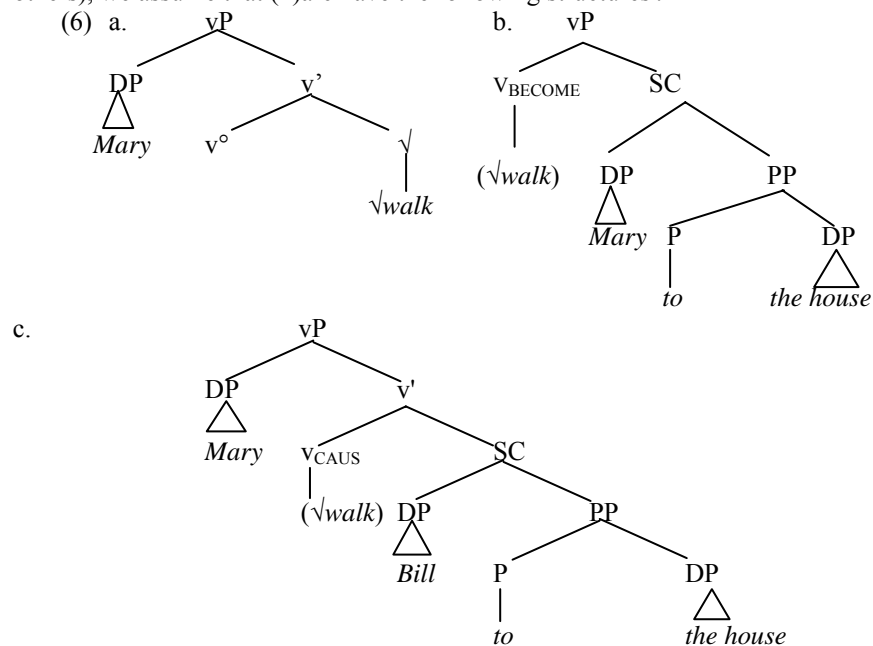

Although it is difficult to argue for an unaccusative analysis of the (b) structures in English, languages like Dutch (Hoekstra & Mulder 1990) and Italian (Folli 2001) provide evidence for this hypothesis because the presence of the PP is necessary to get the resultative interpretation and the auxiliary selected is the one typically selected with unaccusative verbs:

- (7) a. Jan is/*heeft *(in der sloot gesprongen).
 John is/*has in the ditch jumped.
 ‘John jumped in the ditch.’
 b. Gianni é/*ha corso *(nel bosco).
 Gianni is run into the woods
 ‘John ran into the woods.’

On the other hand, in Italian a prepositional phrase headed by *nel* ‘in’ can be used in conjunction with *avere* in a sentence like *Gianni ha corso nel bosco per due ore* (John has run in the woods for two hours). In this case the Locative PP is optional and the auxiliary selected is the one typically used in unergative/activity-like structures.ⁱⁱ We argue that the difference between a Locative PP and a Path PP is reflected structurally, with the first being an adjunct to vP, hence optional, and the second being the secondary predicate of the small clause, hence a proper argument within vP. Evidence for this distinction can be found by performing a series of tests (adapted from Tunsteth 2004):

- (8) *Switching the order of a Goal PP and a Location PP worse than switching two Location PPs*
 a. Sue danced to the bathroom at the party.
 b. ??Sue danced at the party to the bathroom.
 c. Sue danced at the party in the bathroom.
 d. Sue danced in the bathroom at the party.
- (9) *Temporal adverb intervening between V and Goal PP worse than adverb intervening between V and Location PP*
 a. Sue danced at the party for hours/ for hours at the party.
 b. Sue walked to the bathroom in a minute /??in a minute to the bathroomⁱⁱⁱ.
- (10) *Do-so elision of vP wants to include PP args and Goal PPs, but not Location PPs^{iv}*
 a. Mary kissed John in the park and Sue did so in the bedroom.
 b. ??Sue gave a book to John and Mary did so to Bill.
 c. ??Sue danced to the bathroom and Mary did so to the kitchen.

Moreover, Zubizarreta and Oh (2004:62 n. 7) suggest that the weak-island argument-adjunct extraction asymmetry points in this direction too:

- (11) *Argument extraction from weak islands better than adjunct extraction*
 a. *When_i do you wonder whether Snow White will eat an apple t_i ?
 b. ? What_i do you wonder whether Snow White will eat t_i on Thursday?
- (12) *Goal PP extraction better than location PP extraction from weak islands*
 a. *[At which party]_i do you wonder whether Sue will dance t_i ?
 b. ?[To which house]_i do you wonder whether Sue will walk t_i ?

Finally, Bresnan (1992) notes that locative inversion is possible for verbs of motion with Goal PPs but not Location PPs in these constructions. Since

locative inversion is movement to an A-position, it should be good for arguments but not adjuncts:

(13) *Locative inversion only good with Goal PP*

- a. *At the party danced a smiling girl.
- b. Into the room danced a smiling girl.

In conclusion, with most of the literature, we think that the above tests provide strong arguments in favor of the vP-interior nature of the goal PP.

2.1 Unbounded causatives

Folli and Harley (2002) and Zubizarreta and Oh (2004) note that accounts which connect the licensing of the unaccusative structures in (6)b to telicity per se cannot be correct.^v F&H make the same point for the causative structures in (6)c. If we replace the telicity-inducing *to* P in a causative like (6)c with an unbounded directional P like *towards*, *along* or *around*, the causative structure is still licensed:

- (14)a. John waltzed Matilda around and around the room for hours.
- b. John walked Mary along the river all afternoon.
- c. John ran the dog up and down the path for hours
- d. John jumped the horse back and forth across the ditch for 30 minutes.

Similarly, in Dutch and Italian, the *be* auxiliary is licensed for goal PPs headed by unbounded directional Ps, indicating these PPs are still triggering the unaccusative structure, although they are atelic:

- (15)a. Gianni é corso verso il bosco (per ore).
John is run towards the woods (for hours).
'John ran towards the woods.'
- b. Gianni é scivolato in direzione della pianta.
J. is slid in the direction of the tree.
'John slid in the direction of the tree.'
- c. Jan is naar het bos gerend.
Jan is towards the woods run.
'Jan ran towards the woods.'

In English, these atelic Goal PPs behave the same as their telic counterparts with respect to the tests for vP-internalness described above:

- (16) *Switching the order of a Goal PP and a Location PP worse than switching two Location PPs*
- a. Sue danced **around** the bathroom at the party.
- b. ??Sue danced at the party **around** the bathroom.
- c. Sue danced at the party in the bathroom.
- d. Sue danced in the bathroom at the party.

- (17) *Temporal adverb intervening between V and Goal PP worse than adverb intervening between V and Location PP*
- Sue danced at the party for hours/ for hours at the party.
 - Sue danced around the room for hours/??for hours around the room.
- (18) *Do-so elision of vP wants to include PP args and Goal PPs, but not Location PPs*
- Mary kissed John in the park and Sue did so in the bedroom.
 - ??Sue gave a book to John and Mary did so to Bill.
 - ??Sue danced **around** the bathroom and Mary did so **around** the kitchen.
- (19) *Goal PP extraction better than location PP extraction from weak islands*
- *[At which party]_i do you wonder whether Sue will dance t_i ?
 - ?[**Towards** which house]_i do you wonder whether Sue will walk t_i ?
- (20) *Locative inversion only good with Goal PP*
- *At the party danced a smiling girl.
 - Around** the room danced a smiling girl.

From this discussion we can conclude that structure is the crucial factor in allowing an unaccusative or causative of a manner of motion verb, not the telicity of the prepositional phrase involved. In general, we claim that the secondary predication introduced by the small clause involves a measuring out of the resultant event (Tenny 1987) and content of P head simply determines whether measuring-out results in a bounded, telic event or an unbounded, atelic event.^{vi} Therefore semantic-mapping accounts based on identifying telic meanings cannot account for the data discussed in this section (though they could work for other English resultatives, see Wechsler 2001).

3. The Accompanied-Motion Requirement

We claim that the (late) insertion of verbs as the manner spell-out of v in structures like 6b and 6c depends on whether they can be related to the argument structure of the clause (see Harley 2005 for discussion of this treatment of manner incorporation). In a causative sentence of a manner of motion verb as *Mary walked Bill to the house* (cf. (6)c for its structure), the v° takes a SC as its complement and a Causer/Agent DP as its specifier. In the previous section we have argued that the SC represents the Path that measures-out the resultant event. More specifically, we wish to argue that verb roots can be (late) inserted into v° as manner elements, if their semantics involves either an Agent, a Path, or both. If neither an Agent nor a Path is part of the semantics of the root, the verb is incompatible with the causative motion construction. Conversely, when the semantics of the verb involves *both* an Agent and a Path, the accompanied-motion reading is forced.

More specifically, two extra semantic effect can identified by considering in turn the relevance of the Path and Agent components of manner verbs. First, the measuring-out effect of the Path on the resultant event means that, for a verb that selects a Path, the manner denoted by the verb has to extend for the entire temporal duration of the event. Second, if a verb selects for both a Path and an Agent, then the Agent also has to participate in the manner for the entire event.

This idea is based on Levin and Rappaport (1999)'s observation that the causing event and the result event in resultatives formed from transitive verbs must be coterminous if the verb selects for the argument of which the result is predicated; the two events don't need to be coterminous if the resultant argument is unselected (fake reflexive, *way*-construction, etc.)

- (21) a. Mary danced out of the room.
 (dancing and motion out of the room coterminous)
 b. Mary danced herself stiff.
 (dancing may end well before onset of stiffness)

Notice that in these motion causatives, *all* the objects of which the results are predicated are unselected. The crucial factor is whether the Path (and Agent) is selected.

3.1 The four manner-of-motion verb classes

The verbs which can appear with a directional PP fall into four distinct categories defined by their Agent and Path implications. We've provided examples of each of the four types in Table 1.

(22) Table 1

	+Path	-Path
+Agent	walk, run, swim	whistle, hiss, sing
-Agent	roll, float, slide	shudder, tremble

The classification of verbs like *walk*, *run*, *swim*, *whistle*, *hiss* and *sing* as requiring an Agent (a teleologically capable doer of the action) should be uncontroversial.^{vii}

Similarly, it is clear that *roll*, *float*, *slide*, *shudder* and *tremble* can be non-Agentive (e.g. *The tree shuddered when the axe struck it*).

More problematic might be the claim that *walk*, *run*, *swim*, *roll*, *float* and *slide*, unlike the other verbs in our table, select for a Path, since all of those verbs can occur with a directional Path PP:

- (23) a. Mary walked to the store.
 b. The log rolled along the beach.
 c. The bullet whistled through the window.
 d. The train shuddered into the station.

Crucially, even though all those verbs can occur with Path PP, and the tests used in section 2 confirm their occurrence in the same structural position, extraction data seem to suggest that a distinction can be drawn between verbs

that have a selectional relation with the Path PP and verbs that don't (Tenny 1995, Folli 2001):

- (24)a. How far did Sue walk?
 b. How far did the log roll?
 c. *How far did the bullet whistle?
 d. *How far did the train shudder?

The fact that *whistle* and *shudder* do not select for a Path explains why when the SC predicate is filled only by a trace, instead of a full PP, the interpretation is degraded and the sentences become ungrammatical.^{viii} The PP in these cases is purely structurally licensed; the verb is inserted as a manner component to realize the BECOME operator.

3.2 Causatives of the four classes of motion verbs

Interestingly, each of these four classes behaves differently in causatives. In this section, we consider each of these motion verbs in a causative syntax, paying attention to whether the causing event and the caused event must occur contemporaneously (i.e. whether the *accompanied-motion* requirement holds). First, [-Agent, -Path] verbs like *shudder* do not causativize, no matter whether the action of Agent is accompanying the motion event of the object:

- (25)[-Agent], [-Path]
 a. *Bill shuddered the shopping cart across the parking lot.
 (e.g. by giving it a hard push).
 [-accompanying]
 b. *Bill shuddered the cart across the parking lot.
 (e.g. walking along pushing it)
 [+accompanying]

Second, [+Agent], [-Path] verbs like *whistle* causativize without the accompanied-motion reading (see Levin and Rappoport-Hovav 1999):

- (26)[+Agent], [-Path]
 a. Mary whistled Rover to her side.
 [-accompanying]
 b. ?? Mary whistled Rover down the path.
 (where both Mary and Rover are going down the path)
 [+accompanying]

Third, [-Agent], [+Path] verbs like *roll* again causativize both ways:

- (27)[-Agent], [+Path]
 a. The tide rolled the log up the beach.
 [+accompanying]
 b. Bill rolled the ball to the toddler.
 [-accompanying]

Finally, [+Agent], [+Path] verbs causativize only in [+accompanied] readings

(28) [+Agent], [+Path]

- a. *John walked the child onto the stage.
[-accompanying]
(e.g. he mimed walking confidently in the wings and then the child was encouraged and walked onstage herself).
- b. Mary walked John to his house.
[+accompanying]

Notice that with this class of verbs, the agent's action doesn't have to be an *instance* of the motion described by the verb ((29)a-c below), nor does the object's ((29)d-e below). But crucially, the agent's action, whatever it is, must be *cotemporaneous* with the resultant motion event: it cannot be temporally dissociated from it, and the causing event and the motion event overlap totally in each case.

- (29) a. The boy jumped the action figure across the table.
b. Sue ran the car into the wall.
c. John danced the puppet across the stage.
d. John ran the package to the office.
e. Mary walked the bicycle to the shop.

Below we provide a table summarizing the behavior of each class of verbs in the causative construction:

(30) Table 2

Verb class	Accompanied motion?	
	+accomp	-accomp
-Path, -Agent (<i>shudder</i>)	*	*
-Path, +Agent (<i>whistle</i>)	?	3
+Path, +Agent (<i>walk</i>)	3	*
+Path, -Agent (<i>roll</i>)	3	3

3.3 Table 2 and the Event-Path homomorphism requirement

The consideration of each case has given the following results. When a verb selects for neither an Agent nor a Path, a causative cannot be formed (**Bill shuddered the cart across the parking lot*). When a verb selects for just an Agent, but not a Path, a causative may be formed. There is no required temporal overlap between manner and motion, and no accompanied-motion requirement (*Mary whistled Rover down the path*). When a verb selects for a Path but not an Agent, there is a required overlap between manner and motion (the event-path homomorphism), but there is no accompanied-motion requirement. When a verb selects for both an Agent and a Path, the required overlap between manner and motion extends to the Agent too, and results in an accompanied-motion requirement.^{ix}

4. Intentionality

With non-Agent selecting manner verbs like *roll*, we see an interesting effect of intentionality. With an intentional subject, the motion event may be accompanied or not. With a non-intentional subject, the motion event must be accompanied

- (31) a. The tide rolled the log up the beach.
(accompanied)
b. *The slope rolled the ball past Mary's house.
(not accompanied, bad)

In other words, when the external argument is a Causer, not an Agent, the homomorphism has to carry along the Causer — the dissociation between Cause and resultant event is in this case impossible.

Interestingly, a non-intentional Causer cannot be the subject of causatives containing either type of what we have called the Agent-selecting verbs:

- (32) a. *The teakettle whistled Mary into the room.
b. *The wind walked the dog into the house.

Independently of whether the motion is accompanied or not, these causatives are impossible.

4.1 A sub-class of *run*-verbs: 'strong' manner of motion verbs

In this section, we consider briefly the case of verbs like *amble*, *saunter*, *stroll* which pattern with *run*, *walk*, *swim* in selecting an Agent and allowing a distance-measure:

- (33) a. How far did John saunter?
b. How far did Mary stroll?

Unlike *run*, *walk*, *swim* on the other hand they sound very odd in causatives:

- (34) a. #Mary strolled John home.
b. ?#Sue ambled the package to the office.

They are also unlike *run*, *walk*, *swim* in disallowing referential Path-denoting direct objects (Tenny 1995):

- (35) a. Mary walked the Appalachian Trail.
b. Sue swam the English Channel.
c. #Mary ambled the Appalachian Trail.
d. #John strolled the Pacific Crest Trail.

This class represents a puzzle, because as things stand, we predict that these should be fine in causatives, and should behave like *walk* given that they select both an Agent and a Path. We speculate that although in principle they *should be* fine in causatives, the maximally internally-controlled nature of the manner they denote just makes it hard to find the right cases. This may be related to the variable behavior of internally caused verbs like *grow* (causativizable in English but not Italian) and *bloom* (not causativizable in either language).

5. Conclusions

The availability of a small-clause syntax is what allows for the occurrence of causative formation with verbs of manner of motion. The verb is late-inserted into the structure as a manner spell-out of the CAUSE head and the insertion is restricted by a requirement that the verbal meaning be relatable to the CAUSE head's meaning/selectional properties, hence ruling out causatives of *shudder*-verbs. When the verb selects for a Path, the manner described by the verb must extend for the duration of the resultant event, because an event-Path homomorphism effect is imposed. If the verb doesn't select for a Path, the manner need not extend for the duration of the resultant event — no event-Path homomorphism is imposed. When the verb *also* selects for an Agent, the Agent's action must also extend for the duration of the resultant event — the Agent becomes involved in the event-Path homomorphism, forcing the accompanied-motion reading.

Notes

ⁱ The (late) insertion of a root to spell-out the Manner of the change-of-state head in (b) or causative head in (c) is a process that is famously free in English but fettered in Romance (Talmy 1985 et seq.); this is a syntactic instantiation of Manner Incorporation, or what Jackendoff (1990:224) calls the 'GO-adjunct rule'

ⁱⁱ For extensive discussion of these facts in Dutch see Koopman (2001) and den Dikken (2003).

ⁱⁱⁱ Sentences (8)b and (9)b are acceptable with a parenthetical interpretation

^{iv} Zubizarreta and Oh (2004:Ch. 2, p9) give an example equivalent to (10b) as grammatical, but we find it degraded. They note (64, n. 2) that the *do-so* test does work cleanly for pure motion verbs like *go*: **John went into the house and Sue did so into the barn*. The variability may be due to the absence of any manner content for *go*, which makes it extremely odd to elide (it's already as 'light' as it can get).

^v The problem with generally connecting unaccusativity to telicity is articulated clearly by Levin and Rappoport (1995: 172), and Hay, Kennedy and Levin (1999) with respect to examples like *The temperature decreased for/in an hour*; here we are concerned with the smaller claim that goal-of-motion constructions must be telic.

^{vi} Zubizarreta and Oh 2004 use 'bounded' to mean something like 'scalar', 'gradable', equating it to Krifka's notion of non-divisive reference, thus distinguishing 'bounded' from 'telic'. We use 'bounded' as equivalent to 'telic' here and would use 'gradable' or 'scalar' for Z&O's 'bounded'. The difference between telic and atelic prepositions here is essentially equivalent to Kennedy 1999's distinction between closed-scale and open-scale gradable adjectives.

^{vii} Note that agentivity is not, in this view, incompatible with an unaccusative syntax — the presence of *walk* as a manner element in structures like 6b above is fine, although there is no external argument. Even when modified by agent-oriented adverbs like *on purpose*, unaccusative diagnostics such as auxiliary selection give the same result:

- | | | |
|--------|--------------------------------|------------------|
| (i) a. | Gianni é caduto/*ha caduto | apposta. |
| | John is fallen / has fallen | on purpose. |
| b. | Gianni é rotolato/*ha rotolato | giu apposta. |
| | John is rolled/has rolled | down on purpose. |

(Although *rotolare* is better with *ha* than *cadere* is, this is due to the fact that *rotolare* is optionally transitive, so the *ha rotolare* sequence, while ungrammatical in this structure, is familiar from transitive constructions; it's a type of garden-path effect.)

^{viii} The selected PP with verbs like *walk* and *roll* is D-linked, in the terms of Pesetsky (1987), allowing reconstruction and interpretation of the questioned degree phrase.

^{ix} The Path-relatedness of the constraint on accompanied-action readings exhibited here is crucially different from the selected-object constraint cotemporaneousness described by Rappaport and Levin 1999. There, they discuss verbs that do not select Paths or objects, like *wiggle*, and contrast them with verbs that select objects but not Paths, like *wipe*. Here, none of the verbs under consideration selects an object. The cotemporaneousness requirement we observe here, then, does not relate to object-selection, but rather Path-selection.

References

- Bresnan, Joan. 1994. Locative inversion and the architecture of universal grammar. *Language*, 70.1:2--131.
- Dikken, Marcel den. 2003. On the syntax of locative and directional adpositional phrases. Unpublished ms., CUNY.
- Folli, Raffaella. 2001. *Constructing telicity in English and Italian*. Ph.D. dissertation, University of Oxford.
- Folli, Raffaella. & Harley, Heidi. 2002. *Waltzing Matilda around and around Threshold vs. endpoint sub-events*, paper presented at the *Konstanz Workshop on Sub-Events*.
- Hale, Ken. & Keyser, Samuel J. 1993. On argument structure and the lexical expression of syntactic relations. In Hale, K. & Keyser, S.J. (eds.). *The view from building 20: essays in linguistics in honor of Sylvian Bromberger*. Cambridge Mass.: MIT Press. 53-109.
- Hay, Jennifer, Kennedy, Christopher & Levin, Beth 1999. Scalar structure underlies telicity in 'degree achievements'. In T. Mathews & Strolovitch, D. (eds.) *Proceedings of SALT IX*. Ithaca: CLC Publications. 127-144.
- Harley, Heidi. 2005. "How do verbs get their names? The aktionsart of denominal verbs and the ontology of verb roots in English." In *The Syntax of Aspect: Deriving Thematic and Aspectual Interpretation*, ed. by Nomi Erteschik-Shir and Tova Rapoport. Oxford University Press: Oxford.
- Hoekstra, Teun & Mulder, Jan. 1990. Unergatives as copular verbs. *The Linguistic Review* 7. 1-79.
- Jackendoff, Ray. 1990. *Semantic Structures*. MIT Press: Cambridge.
- Kennedy, Christopher. 1999. *Projecting the Adjective: The Syntax and Semantics of Gradability and Comparison*. Garland: New York.
- Koopman, Hilda. 2000. Preposition, postpositions, circumpositions and particles. In: *The Syntax of Specifiers and Heads. Collected Essays of Hilda Koopman*. Routledge: London.
- Krifka, Manfred. 1998. 'The origins of telicity,' in S. Rothstein (ed.), *Events and Grammar*. Dordrecht: Kluwer. 197-236.
- Levin, Beth & Rappaport-Hovav Malka. 1995. Unaccusativity: at the syntax-lexical semantics interface. Cambridge, Mass.: MIT Press.
- Levin, Beth & Rappoport-Hovav, Malka. 1999. "Two structures for compositionally derived events." *Proceedings of SALT 9*, 199-223. Ithaca, NY: Cornell Linguistics Circle Publications, Cornell University.
- Pesetsky, David. 1987. "Wh-in-situ: Movement and unselective binding." In E. Reuland and A. ter Meulen, (eds.) *The Representation of (In)definiteness*, 98-129. Cambridge, MA: MIT Press.

- Talmy, Leonard. 1985. Lexicalization patterns: semantic structure in lexical forms. In Shopen, T. (eds.) *Language typology and syntactic description III: grammatical categories and the lexicon*. Cambridge: Cambridge University Press. 57-149.
- Tenny, Carol. 1987. *Grammaticalizing aspect and affectedness*. Ph.D. Dissertation, MIT.
- Tenny, Carol. 1995. "Modularity in Thematic versus Aspectual Licensing: Paths and Moved Objects in Motion Verbs." *Canadian Journal of Linguistics* 40.2: 201-234.
- Tungseth, Mai. 2004. "PP, PathP and the telic/atelic distinction in Norwegian motion constructions." In Slabakova, R. & Kempchinsky, P. (eds.) *Aspectual Inquiries*. Dordrecht: Kluwer.
- Wechsler, Stephen. 2001. Resultatives under the Event-Argument Homomorphism Model of Telicity. Ms., University of Texas at Austin.
- Zubizarreta, Maria Luisa, and Oh, Eunjeong. 2004. The lexicon-syntax interface: The case of motion verbs.

Raffaella Folli
 Room 17E03, School of Communication
 University of Ulster
 Jordanstown campus
 Shore Road, Newtownabbey
 Co. Antrim, United Kingdom
 BT37 0QB
r.folli@ulster.ac.uk

Heidi Harley
 Department of Linguistics
 University of Arizona
 Tucson, AZ 85721-0028
hharley@email.arizona.edu

An Argument for a Presuppositional Treatment of Neg-Raising Predicates

Jon Gajewski

Massachusetts Institute of Technology

1 Introduction

The goal of this paper is to argue for the claim in (1). The characteristic behavior of Neg-Raising Predicates with respect to negation is explained in terms of this presupposition.

- (1) Neg-Raising predicates carry a homogeneity presupposition.

1.1 What is a Neg-Raising Predicate?

By Neg-Raising Predicate (NRP), I refer to those predicates that validate the following inference schema:

- (2) *Neg-Raising*
 [not [NRP [S]]] implies [NRP [not [S]]]

Here are some examples of NRPs collected by Larry Horn:

- (3) The classes of Neg-raisers (Horn 1978)
 a. [OPINION] think, believe, expect, suppose, imagine, reckon
 b. [PERCEPTION] seem, appear, look like, sound like, feel like
 c. [PROBABILITY] be probable, be likely, figure to
 d. [INTENTION/VOLITION] want, intend, choose, plan
 e. [JUDGMENT/OBLIGATION] be supposed, ought, should, advise

For these predicates, the (b) sentences follow from the (a) sentences in (4)-(6).

- (4) a. Bill doesn't think that Mary is here.
 b. Bill thinks Mary is not here.
 (5) a. Bill doesn't want to go.
 b. Bill wants to not go.
 (6) a. It doesn't seem that Mary is here.
 b. It seems that Mary is not here.

This contrasts with the inferences associated with non-NRPs such as *know*, *say* and *certain*.

- (7) a. Bill doesn't know that Mary is here.
b. Bill knows that Mary isn't here.
- (8) a. Bill didn't say that Mary was there.
b. Bill said that Mary wasn't there.
- (9) a. It's not certain that Mary will leave.
b. It's certain that Mary will not leave.

None of the (a)-sentences in (7)-(9) implies its corresponding (b)-sentence.

In addition to these entailment intuitions, NPI licensing can be used to diagnose NRPs. Certain so-called strict NPIs (like 'punctual' *until*, *in weeks* and *can help*) are licensed by the negation of a higher predicate only if that predicate is Neg-Raising.

- (10) a. I didn't want Mary to leave until tomorrow.
b. I don't think Bill has visited Mary in weeks.
c. It doesn't seem that Bill can help eating Twinkies.
- (11) a. *I didn't say that Mary would leave until tomorrow.
b. *Fred doesn't know that Bill has visited Mary in weeks.
c. *It's not certain that Fred can help eating Twinkies.

1.2 Proposal

I propose that this behavior is analogous to the behavior of definite plural noun phrases and should receive the same analysis.

2 Definite Plural Noun Phrases and Negation

Statements involving definite plurals are often roughly synonymous with sentences involving universal quantifiers. For example, (12a) means roughly (12b).

- (12) a. Sue saw the boys.
b. Sue saw every boy.

Definite plurals and universal quantifiers, however, show different behavior with respect to negation.

- (13) a. Sue didn't see the boys.
b. Sue didn't see every boy.

Though the definite plural appears in the surface scope of negation in (13a), this sentence lacks the reading of a universal scoping under negation, which is the most natural reading of (13b). Instead (13b) is roughly equivalent to (14).

- (14) Every boy is such that Sue didn't see him.
(Sue saw none of the boys)

We can describe this as a kind of Neg-Raising:

- (15) '*Neg-Raising*' of *Definite Plurals*
[not [Pred *the* ϕ s]] implies [*the* ϕ s_i [not [Pred t_i]]]

Possible illustrations of (15) for (13) are the sentences in (16), which are implied by (13a).

- (16) a. The boys were not seen by Sue.
b. The boys, Sue didn't see.
c. The boys are such that Sue didn't see them.

2.1 Explaining the interaction of definite plurals and negation

Fodor 1970 proposed an explanation for the way definite plurals interact with negation. She proposes that definite plurals are universal quantifiers. In addition, however, she proposes that definite plurals carry a homogeneity presupposition¹ (17b), that is, a presupposition that says that the predicate applied to the definite plural is either true of all of the individuals in its restrictor or none of them.

- (17) *the* ϕ s are P
a. Truthconditions: $\forall x [\phi(x) \rightarrow P(x)]$
b. Presupposition: $\forall x [\phi(x) \rightarrow P(x)] \vee \forall x [\phi(x) \rightarrow \neg P(x)]$

This explains the behavior of definite plurals with respect to negation in the following way. Consider for example (12a).

- (18) a. (12a): *Sue saw the boys*.
b. Truthconditions: when defined, (12a) is True iff Sue saw every boy
c. Presupposition: (12a) is defined only if either Sue saw every boy or
Sue saw no boy

Because presuppositions survive negation, (13a), the negation of (12a), carries the same presupposition as (12a).

- (19) a. (13a): *Sue didn't see the boys*.

- b. Truthconditions:
 when defined, (13a) is True iff Sue didn't see every boy
- c. Presupposition:
 (13a) is defined only if either Sue saw every boy or Sue saw no boy

The presupposition and truthconditions of (19) together entail (20).

(20) Sue saw no boys.

2.2 Evidence for presupposition

This analysis of definite plurals is supported by direct arguments that constructions involving definite plurals carry such a homogeneity presupposition.

One piece of support involves truthvalue judgments. Von Stechow 1997 provides the following example:

(21) Consider a situation where all of ten children are playing, among them are three boys and seven girls. The following judgments seem natural:

TRUE:	The children are playing.
FALSE:	The children are not playing.
?:	The children are boys.

This example shows that when the restrictor of a definite is divided with respect to the predicate it is difficult to judge the truth of a statement. The presence of a homogeneity presupposition would account for this intuition.

Another piece of evidence comes from definite plurals in questions. The presuppositions of sentences survive when they are embedded in yes-no questions. So, if constructions involving definite plurals carry a homogeneity presupposition, we expect questions that embed them to carry that presupposition as well. Consider (22).

(22) Are the boys blond?

In a scenario where some of the boys are blond, it is difficult to answer this question with a straight yes or no. A “no” answer is too strong, it implies that none of the boys are blond. I take this as evidence that the question indeed carries a homogeneity presupposition.

2.3 Formalization

2.3.1 *Definite plurals denote pluralities*

Fodor's analysis is successful in explaining the interaction of definite plurals and negation but relies on the suspect assumption that definite plurals denote universal quantifiers. It has often been argued that definite plurals cannot be

universal quantifiers because this does not offer an adequate analysis of collective predication with definite plurals. For this reason, many propose to treat definite plurals as denoting pluralities. I follow Schwarzschild 1996 in assuming that pluralities are just sets of atomic entities. For example,

$$(23) \quad \llbracket \text{the children} \rrbracket = \{x: x \text{ is a child}\}$$

2.3.2 *Universal force is contributed by a distributive operator on the predicate*

What happens when a predicate of individuals is predicated of a plurality? For example in (24).

$$(24) \quad \text{the children are blond}$$

For interpretability a distributive operator (25) is added to the predicate.

$$(25) \quad \llbracket \text{Dist} \rrbracket = \lambda f_{et}. \lambda F: F \subseteq D_e. \forall x [x \in F \rightarrow f(x) = 1]$$

So, the Logical Form of (24) is (26).

$$(26) \quad \llbracket \text{the children} [\text{Dist} [\text{are blond}]] \rrbracket$$

2.3.3 *The distributive operator carries the homogeneity presupposition*

This is the natural way to transpose Fodor's assumptions now that the distributive operator contributes universal force. Schwarzschild 1994 offers the most perspicuous analysis of how homogeneity presuppositions arise from applying Dist to predicates of individuals. I give the following formalization, which is compatible with the results of his account:

(27) *Distributive Operator with Homogeneity Presupposition*

$$\llbracket \text{Dist} \rrbracket = \lambda f_{et}. \lambda F: F \subseteq D_e. \forall x [x \in F \rightarrow f(x) = 1] \vee \forall x [x \in F \rightarrow f(x) = 0].$$

$$\forall x [x \in F \rightarrow f(x) = 1]$$

This formalization yields the correct truthconditions and presupposition for (24).

$$(28) \quad \llbracket \text{the children Dist are blond} \rrbracket \text{ is defined only if}$$

$$\llbracket \text{the children} \rrbracket \text{ is in the domain of } \llbracket \text{Dist are blond} \rrbracket \text{ iff}$$

$$\{x: x \text{ is a child}\} \text{ is in the domain of } \llbracket \text{Dist are blond} \rrbracket \text{ iff}$$

$$\text{every child is blond or no child is blond.}$$

$$(29) \quad \text{When defined, } \llbracket \text{the children Dist are blond} \rrbracket \text{ is True iff}$$

$$\llbracket \text{Dist are blond} \rrbracket (\llbracket \text{the children} \rrbracket) = 1 \text{ iff}$$

$$\text{every child is blond.}$$

3 A New Analysis for Neg-raising Predicates

In this section I argue that we want to account for the interaction of NRPs with negation in the same way we account for the interaction of definite plurals with negation: in terms of a Homogeneity presupposition induced by distributive plural predication.

3.1. Sketch

Consider how this would work for the NRP *think*:

(30) Standard Analysis: $\llbracket \text{think} \rrbracket^w = \lambda p_{st}.\lambda x. \forall w' [w' \text{ is compatible with } x\text{'s beliefs in } w \rightarrow p(w') = 1]$

(31) New Proposal:
 $\llbracket \text{think} \rrbracket^w = \lambda x. \{ w' : w' \text{ is compatible with } x\text{'s beliefs in } w \}$

Given (31), the structure for a sentence with an NRP is as in (32).

(32) a. Bill doesn't think Mary is here.
 b.

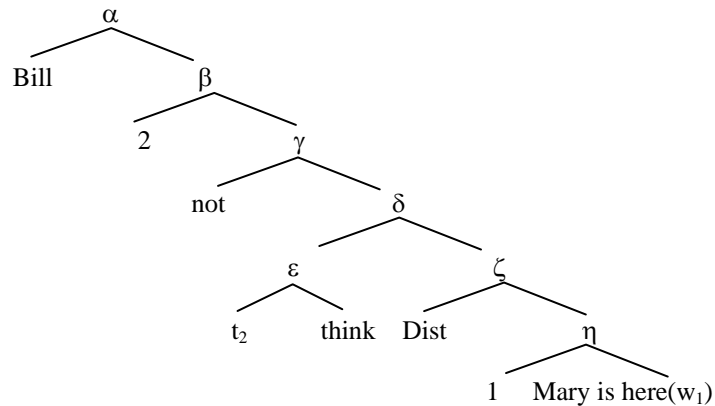

(i) $\llbracket \text{Dist} \rrbracket = \lambda f_{st}.\lambda F:F \subseteq D_s: \forall x[x \in F \rightarrow f(x) = 1] \vee \forall x[x \in F \rightarrow f(x) = 0].$
 $\forall x[x \in F \rightarrow f(x) = 1]$

(ii) $\llbracket \epsilon \rrbracket^{w,g[2 \rightarrow \text{Bill}]} = \{ w' : w' \text{ is compatible with Bill's beliefs in } w \}$

(iii) $\llbracket \zeta \rrbracket^w = \lambda F:F \subseteq D_s \ \& \ \forall x[x \in F \rightarrow \llbracket \eta \rrbracket(x) = 1] \vee \forall x[x \in F \rightarrow \llbracket \eta \rrbracket(x) = 0].$
 $\forall x[x \in F \rightarrow \llbracket \eta \rrbracket(x) = 1]$

(iv) $\llbracket \delta \rrbracket^w$ is defined only if
 $\forall x[x \in \{ w' : w' \text{ is compatible with Bill's beliefs in } w \} \rightarrow \llbracket \eta \rrbracket(x) = 1] \vee$
 $\forall x[x \in \{ w' : w' \text{ is compatible with Bill's beliefs in } w \} \rightarrow \llbracket \eta \rrbracket(x) = 0]$
 (i.e., if Bill thinks Mary is here or he thinks she is not)

- (v) When defined $[[\delta]]^w$ is true iff
 $\forall x [x \in \{w' : w' \text{ is compatible with Bill's beliefs in } w\} \rightarrow [[\eta]](x) = 1]$
 (i.e., Bill thinks Mary is here)

- (33) a. Bill doesn't believe Mary is here.
 b. Assertion:
 $\sim \forall w [w \text{ is compatible with Bill's beliefs} \rightarrow \text{Mary is here in } w]$
 c. Presupposition:
 $\forall w [w \text{ is compatible with Bill's beliefs} \rightarrow \text{Mary is here in } w] \vee$
 $\forall w [w \text{ is compatible with Bill's beliefs} \rightarrow \sim \text{Mary is here in } w]$

Again, together the assertion and presupposition of (33) entail (34).

- (34) Bill believes that Mary is not here.

3.2. NRPs carry homogeneity presuppositions

In this section I show that a surprising contrast in NPI-licensing under stacked NRPs is straightforwardly explained by assuming that NRPs carry a homogeneity presupposition.

3.2.1. (Partial) Cyclicity

One classic argument given for the syntactic approach to NR was that the phenomena appeared to be cyclic. For example, (35a) can be taken to mean (35b).

- (35) a. I don't imagine Bill thinks Mary wants Fred to go.
 b. I imagine Bill thinks Mary wants Fred to not go.

Such facts led many to believe that negation underwent a series of local cyclic movements:

- (36) [I _ imagine [Bill thinks [Mary want [Fred not to go]]]]
-

Horn and Morgan (reported in Horn 1972) point out a problem for this simple picture. As they show, the order of the predicates in the sentence determines whether or not "cyclic" neg-raising is possible. They consider minimal pairs such as (37).

- (37) a. I don't think Bill wants Mary to leave.
 b. I don't want Bill to think Mary left.

According to Horn and Morgan, cyclic neg-raising is possible in (37a) but not in (37b). That is, (37a) can be understood as equivalent to (38a), but (37b) cannot be understood as equivalent to (38b).

- (38) a. I think Bill want Mary not to leave.
b. I want Bill to think Mary didn't leave.

They support this claim with evidence from NPI-licensing:

- (39) a. I don't think Bill wants Mary to leave until tomorrow.
b. #I don't want Bill to think Mary left until yesterday.
(*until* understood with most deeply embedded scope)

3.2.2. Explaining the contrast in (39)

The presuppositional approach to Neg-Raising offers an interesting explanation of this contrast. Consider how the presuppositional analysis captures the cyclicity of NR in a sentence like (40a)

- (40) a. I don't think Bill wants Mary to leave.
b.

I have indicated the presuppositions of constituents α and β next to them with an arrow. The entire structure (40b) inherits the presuppositions of α . Presupposition (ii) of α is the homogeneity presupposition associated with *believe*. Presupposition (i), on the other hand, derives from projection of the presupposition of β . Now the assertion of (40a) is (41).

- (41) \sim I think Bill wants Mary to leave.

This combined with presupposition (ii) of α (40b) gives us (42).

- (42) I think \sim Bill wants Mary to leave.

This combined with presupposition (i) of α in (40b) entails that

- (43) I think Bill wants \sim Mary to leave.

If we try to use this reasoning when the predicates are in the reverse order we run into a problem. It is well known that desire predicates differ from doxastic predicates in their presupposition projection properties (cf. Karttunen 1974, Heim 1992). Doxastic predicates, on the one hand, assert that a proposition holds in some doxastic alternatives and presuppose that the presuppositions of its complement hold among those doxastic alternatives. Desire predicates, on the other hand, assert that the complement holds in some bouletic alternatives but presuppose that the presuppositions of their complement hold in the subject's doxastic alternatives. For example, (45) presupposes that Bill believes he has a cello and (46) presupposes not that Bill wants to have a cello, but that he believes he has one.

- (44) Bill will sell his cello.
Presupposition: Bill has a cello.
- (45) Bill thinks he will sell his cello.
Presuppositions: Bill thinks he has a cello.
- (46) Bill wants to sell his cello.
Presupposition: Bill thinks he has a cello
(#Bill wants to have a cello)

Knowing this, consider again the case of (37b):

- (37b) I don't want Bill to think Mary left.

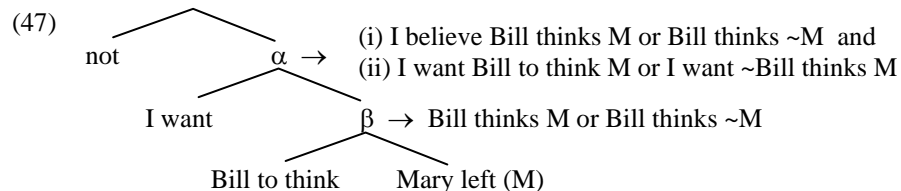

The assertion of (37b) is (48).

- (48) ~I want Bill to think Mary left

This together with presupposition (ii) of α in (48) entails that

- (49) I want ~ Bill to think Mary left

In the case of (37a) we were able to use presupposition (i) of α to infer the final 'cyclic' step of Neg-raising. In this case we cannot. I can believe that Bill

believes M or that he believes not-M, want that it not to be the case that he believes M and still not want Bill to believe not-M.

4 Doubts

If NRPs carry a homogeneity presupposition, we expect the presupposition to be diagnosed by the standard tests for presuppositions – such as those utilized by Fodor 1970. While I do think there are contrasts that go in the right direction, most informants I have consulted do not feel that they are as strong as we would expect if homogeneity were a presupposition.

4.1 Truthvalue judgments

To see whether NRPs carry Homogeneity presuppositions we must check whether they behave similarly to definites with respect to truthvalue judgments.

Suppose it is compatible with Bill's beliefs that Mary is here and it is compatible with his beliefs that she is not. That is, Bill considers both possible. Is (50a) false? Compare (50b).

- (50) a. Bill thinks Mary is here.
b. Bill is certain that Mary is here.

Mary is happy whether she goes to the party or not. That is, Mary is ambivalent about going to the party. Is (51a) false?

- (51) Mary wants to go to the party.

Mary's interests are equally well served whether she goes to the party or not. Is (52a) false? Compare (52b).

- (52) a. (In view of her interests) Mary should go to the party.
b. (In view of her interests) Mary needs to go to the party.

Most of my informants, judge (50a), (51) and (52a) simply false in these scenarios. As has often been pointed out, however, truthvalue-judgments are not the most reliable diagnostics for presupposition (for an enlightening recent discussion see Von Stechow 2004).

4.2 Projection in Questions

Evidence from projection in questions is more encouraging but not overwhelmingly so. In the following examples there is at least a slight preference to read the negative response, as Neg-Raised.

- (53) a. Does Bill think Mary left? No.
b. Is Bill certain that Mary left? No.

- (54) Does Bill want to leave? No.
- (55) a. Should Mary leave? No.
b. Does Mary need to leave? No.

For example, the negative response in (53) conveys that Bill thinks that Mary is did not leave. Similarly, the negative response in (55a) conveys that Mary should stay not merely that she is under no obligation to leave.

5 Conclusion

In conclusion, we have seen evidence from failures of cyclicity in Neg-Raising in favor treating NRPs as carrying a homogeneity presupposition. In addition to this empirical benefit, this analysis allows us to unify the treatment of NRPs with that of definite plurals which display similar behavior with respect to negation. As noted in section 4, more work needs to be done to fully integrate this analysis into a more general theory of presupposition.

Note

¹Fodor refers to this as an “all-or-none” presupposition. I borrow the term “homogeneity” from Löbner 1987 and von Fintel 1997.

Selected References

- Bartsch, Renate. 1973. “Negative Transportation” Gibt es Nicht,’ *Linguistische Berichte*, 27:1-7
- Brisson, Christine. 2003. ‘Plurals, All and the Non-uniformity of Collective Predication,’ *Linguistics and Philosophy*, 26.2: 129-184
- von Fintel, Kai. 1997. ‘Bare Plurals, Bare Conditionals and Only’ *Journal of Semantics*, 14.1:1-56
- von Fintel, Kai. 2004. ‘Would you believe it? The King of France is Back! Presuppositions and Truth-Value Intuitions’ in Anne Bezuidenhout and Marga Reimer (eds.) *Descriptions and Beyond: An Interdisciplinary Collection of Essays on definite and Indefinite Descriptions and other Related Phenomena*, Oxford University Press.
- Fodor, Janet Dean. 1970. *The Linguistic Description of Opaque Contexts*. Ph.D. Thesis MIT.
- Horn, Laurence. 1972. ‘Negative Transportation: Unsafe at Any Speed?’ CLS 7: 120-133
- Horn, Laurence. 1978. ‘Remarks on Neg-raising,’ in Peter Cole (ed.) *Syntax and Semantics 9: Pragmatics*. New York: Academic Press.
- Horn, Laurence. 1989. *A Natural History of Negation*. University of Chicago Press.
- Lakoff, Robin. 1969. ‘A Syntactic Argument for Negative Transportation,’ CLS 5: 149-157
- Löbner, Sebastian. 2000. ‘Polarity in natural language: Predication, quantification and negation in particular and characterizing sentences,’ *Linguistics and Philosophy*, 23.3: 213-308
- Schwarzschild, Roger. 1994 ‘Plurals, Presuppositions and the Sources of Distributivity,’

Natural Language Semantics, 2: 201-248
Schwarzschild, Roger. 1996 *Pluralities*. Dordrecht: Kluwer.

Jon Gajewski, MIT
Department of Linguistics & Philosophy
77 Massachusetts Avenue, 32-D808
Cambridge, MA 02139-4307
jrgajews@mit.edu

Why English and Korean Resultative Constructions Differ

Soo-Min Hong

University of Maryland, College Park

1. Introduction

This paper investigates intriguing differences in the Resultative Construction (RC) between English and Korean. The English RC is well known for the Direct Object Restriction (DOR): a resultative phrase may be predicated of a direct object but neither of a subject nor of an indirect object (Levin and Rappaport Hovav 1995). The Korean RC, in contrast, does not hold of the DOR. That is, a resultative phrase may be predicated of not only a direct object but also a subject and an indirect object. This distinction between English and Korean in the RC may be attributed to a different role of a Small Clause (SC) of the RC. In English a SC of the RC may be a VP complement while in Korean it may be a vP/VP adjunct instead.

2. Some Properties of RCs

The English RC does not pattern with the Korean RC. In essence, English allows the Object Resultative but not the Subject Resultative, whereas Korean permits both the Object Resultative and the Subject Resultative.

2.1 English RCs

English RCs come in the three varieties, as offered in (1) to (4). (1)b has the transitive verb *hammer* as a matrix verb and the resultative phrase *flat* which may only be predicated of the object *the metal*. It can mean that John hammered the metal so it became flat. Yet it cannot mean that John hammered the metal as a result he became flat.

- (1) Matrix verb: transitive verb
 a. John hammered the metal
 b. John hammered the metal flat

The instances in (2) have the unergative verb *run*. An unergative verb does not take the internal argument. In other words, the resultative subject *their Nikes* is not selected by the matrix verb *run* in (2)b.

- (2) Matrix verb: intransitive (unergative) verb
- a. *The joggers ran their Nikes
 - b. The joggers ran their Nikes threadbare
(Carrier and Randall 1992)

The examples in (3) have another kind of unergative verb *shout*. Interestingly, when the resultative predicate *hoarse* appears, the presence of the reflexive *herself* is obligatory. Simpson (1983) dubs this kind of reflexive in RCs a ‘fake reflexive’ as shown in (3)c. Levin and Rappaport Hovav (1995) employ a fake reflexive in support of the DOR. In section 3.1, we attempt to provide a new account for a requirement of a fake reflexive in the RC.

- (3) Matrix verb: intransitive (unergative) verb
- a. *Mary shouted herself
 - b. *Mary shouted hoarse
 - c. Mary shouted herself hoarse (fake reflexive)

Now in (4), the unaccusative verb *freeze* comes with the resultative phrase *solid*. The resultative phrase *solid* is predicated of its surface subject, which is generally assumed to be an underlying object of an unaccusative verb. So far the DOR seems to hold.

- (4) Matrix verb: intransitive (unaccusative) verb
- a. *The lake froze the fish
 - b. The lake froze solid

As can be seen in (5), *his hands* and *his eyes* are in the inalienable possession relation with the subject *John* respectively. Based on an availability of only a bound pronoun reading, Levin and Rappaport Hovav contend that a bound pronoun should be considered to be a fake reflexive. It is far from clear why we should give a special treatment to a bound pronoun in an inalienable possession relation. We will come back to this in section 4.2.

- (5) Inalienable Possession
- a. John_i cooked his_{i/*j} hands dry
 - b. John_i cried his_{i/*j} eyes red
(Bouldin 1990)

2.2 Korean RCs

The Korean data are presented in the same way as the English data in 1.1. Korean RCs come with various kinds of matrix verbs: transitive, ditransitive, unergative, and unaccusative verb.

(6) has the transitive verb *twutulki-* ‘pound’ as a matrix verb and the resultative predicate *napcakha-* ‘flat’. The resultative predicate *napcakha-* ‘flat’ is predicated of the object *kumsok* ‘metal’.

- (6) Matrix verb: transitive verb
 John-i [kumsok-ul napcakha-key] twutulki-ess-ta¹
 John-nom metal-acc flat-key pound-past
 ‘John pounded the metal flat’

The example in (7) with a ditransitive verb comes from S-W Kim and Maling (1997, 1998). Importantly, the resultative predicate *hwui-* ‘bent’ is predicated of the indirect object *sang* ‘table’ not the direct object *umsik* ‘food’. It is a glaring counterexample to the DOR.

- (7) Matrix verb: ditransitive verb
 John-i umsik-ul sang-ey [tali-ka hwi-key] chali-ess-ta
 John-nom food-acc table-on leg-nom bent-key put-past
 ‘John put food on the table, until/so that its legs_i became bent’
 (S-W Kim and Maling 1997)

Consider the below instance with the unergative verb *oychi-* ‘shout’. Unlike the English RC in (3)c, a so-called fake reflexive *caki* ‘self’ is not forced to occur. The absence of the reflexive *caki* by no means affects acceptability of (8).

- (8) Matrix verb: intransitive (unergative) verb
 John-i [mok-i swi-key] oychi-ess-ta
 John-nom throat-nom hoarse-key shout-past
 ‘John_i shouted himself_i hoarse’

(9) has the unaccusative verb *nok-* ‘melt’ along with the resultative phrase *cilpekha-* ‘slushy’. In stark contrast to English in (4), the resultative phrase *cilpekha-* ‘slushy’ is predicated not of the matrix subject, namely, an underlying object *nwun* ‘snow’ but of the resultative subject *kil* ‘road’. It straightforwardly shows a resultative subject can be an independent argument that the matrix verb *nok-* ‘melt’ does not take. This is not expected by the DOR.

- (9) Matrix verb: intransitive (unaccusative) verb
 Nwun-i [kil-i cilpekha-key] nok-ass-ta
 Snow-nom road-nom slushy-key melt-past

‘The snow melted until/so that the road became slushy’
 ‘*The snow melted the road slushy’

(10) demonstrates that an inalienable possession relation of a resultative subject can be established with a matrix subject. The Subject Resultative of (10)b directly goes against the DOR.

- (10) Inalienable Possession
- a. John-i [tali-ka apu-key] kel-ess-ta
 John-nom leg-nom achy-key walk-past
 ‘John_i walked until/so that his legs_i became achy’
- b. John-i Mary-lul [chim-i malu-key] chingchanha-yess-ta
 John-nom Mary-acc saliva-nom dry-key praise-past
 ‘John_i praised Mary_j until his saliva_{i/*j} became dry’

Thus far we have seen that the Korean RC behaves differently from the English RC. A resultative subject can be predicated of not only a direct object but also a subject and an indirect object. Here I pursue the question on why the Korean RC can sidestep a restriction like the DOR unlike English.

3. Availability of Selectional Restriction

It is a well-documented fact that a resultative phrase exhibits a tight connection with a matrix verb (Green 1982, Simpson 1983, Rothstein 1983, Carrier and Randall 1992, among others). But we will see that it is not the case in Korean.

3.1 Restrictive selection of a resultative phrase in English

The choice of a resultative predicate is quite restrictive as shown in (11).

- (11) a. The maid scrubbed the pot [_{Adjective} shiny/*shined/*shining]
 b. The chef cooked the food [_{Adjective} black/*blackened/*charred]
 c. The joggers ran themselves [_{Adjective} sweaty/exhausted/
 *sweating]
 d. The kids laughed themselves [_{Adjective} sick/*sickened]

Various attempts have been made to capture the restrictive selection of a resultative predicate for the RC. One of the common ways is to employ s-selection (semantic selection) since c-selection (category selection) does not play out in determining the class of possible XPs. All the resultative predicates in (11) are arguably adjectives. Yet only some of them are acceptable.

Consider the following paradigm in (12).

- (12) PP/NP Resultative Phrase
- a. She pounded the dough [_{PP} into a pancake]/ * [_{NP} a pancake]
 - b. She painted the barn * [_{PP} (in)to a weird shade of red]/ [_{NP} a weird shade of red]
- (Carrier and Randall 1992)

As for c-selection, the resultative predicates can be PPs and NPs. Although c-selection is met in (12), not all of them are permissible. This leads to a question. Can s-selection explain acceptability of a PP *into a pancake* and unacceptability of an NP *a pancake* in (12)a and conversely unacceptability of a PP *(in)to a weird shade of red* and acceptability of an NP *a weird shade of red* in (12)b? It seems really hard to generalize a semantic type so that it may characterize this idiosyncratic contrast. Along a similar vein, Dowty (1979, 303) notes the following: ... *research on this problem (Green 1972) has uncovered no general principle which predicts this difference in acceptability*. What we deduce from (11) and (12) is that it may not be plausible to explain the idiosyncratic selection of resultative predicates in terms of c-selection and s-selection. Thus we turn to l-selection (lexical selection) in the sense of Pesetsky (1991). L-selection fits well with the fact that only specific resultative predicates can co-occur with a particular matrix verb.

3.2 No restrictive selection of a resultative phrase in Korean

In English I have proposed that l-selection of resultative predicates should be in place. A question arises. Does the Korean RC need l-selection likewise?

As illustrated in (13), Korean is not subject to restrictive selection like English. As opposed to English, Korean allows *panccakkkeli-* ‘shiny, shining’ and *panccakkkelieci-* ‘shined’ for a resultative predicate.²

- (13) a. The maid scrubbed the pot [shiny/*shining/*shined]
 b. Hanye-ka sot-ul [panccakkkeli-key/panccakkkelieci-key]
 Maid-nom pot-acc shiny, shining/shined-key
 mwncile-ss-ta
 scrub-past

We compare the English and the Korean examples with respect to a range of resultative predicates in (14). The English verb *dye* permits exclusively the color adjective like *red* precluding other sorts of adjectives *pretty* and *damaged* in the RC. Yet Korean allows a diversity of adjectives beyond the color adjective *ppalkah-* ‘red’. Here *yeppu-* ‘pretty’ and *sonsangtoy-* ‘damaged’ are both possible resultative predicates in (14)b.

- (14) a. Sue dyed her hair red/*pretty/*damaged
 b. Sue-nun meli-lul ppalkah-key/yeppu-key/sonsangtoy-key

Sue-top hair-acc red-key/pretty-key/damaged-key
 yemsaykha-ess-ta
 dye-past
 ‘Sue dyed her hair red/*pretty/*damaged’

The selectional restriction of resultative predicates relaxes considerably in Korean. Then how can we account for this evident contrast in the degree of restrictiveness on selection of resultative predicates in English and Korean?

Selectional restriction including c-selection, s-selection, and l-selection are imposed through a head-complement relation. Here let us assume that selectional restriction can only be placed on a complement of a lexical head. English shows a highly restrictive selectional restriction of resultative predicates while Korean does not. The freedom in selection of resultative predicates seems to guide us to say that unlike English there may be no selectional restriction of resultative predicates for Korean. If this is true, we can take this one step further. Resultative predicates may not be a part of ν P/VP complement. Rather as for Korean they are hosted by a VP/ ν P adjunct. On this proposal, it is not surprising that the Korean RC does not exhibit as restrictive as selectional restriction of resultative predicates as English. In fact it naturally follows from the treatment of the Resultative predicates as a VP/ ν P adjunct

4. Reflexives and Bound Pronouns on Resultative Subject

Generally it is agreed that the RC contains a secondary subject-predication relation. Here we adopt a so-called Small Clause (SC) analysis following Stowell (1981, 1983), Chomsky (1981), Hoekstra (1988), *inter alia*.³

4.1 Reflexives on resultative subject

As can be seen in (3), in English the presence of a fake reflexive *herself* is required in the RC as repeated in (15).

- (15) a. *Mary shouted herself
 b. *Mary shouted hoarse
 c. Mary shouted herself hoarse

The intransitive verb *shout* can take neither an internal argument *herself* nor a resultative predicate *hoarse* separately. It needs both an internal and its predicate at the same time as presented in (15)c. It lends itself to a SC analysis. On the SC analysis, the necessity of a secondary subject, namely a fake reflexive naturally follows without a reference to the DOR.

4.2 Bound pronouns on resultative subject

As discussed in 2.1, Levin and Rappaport Hovav gives an impromptu treatment to a bound pronoun *his* in (5), as repeated in (16).

- (16) a. John_i cooked his_{i/*j} hands dry
 b. John_i cried his_{i/*j} eyes red

A bound pronoun is stipulated to be taken as a kind of reflexive only when a possessive pronoun is an inalienably possessed NP since both of them are bound by a matrix subject. It seems to be too restrictive on the empirical grounds. It cannot accommodate the following example.

- (17) The joggers_i ran their_{i/*j} Nikes threadbare

Evidently the DP *their Nikes* cannot be considered to be an inalienably possessed NP since it is not a body part. Nevertheless *their* should be a bound pronoun. Importantly it is not a deictic pronoun.

Here we attempt to derive this necessary bound reading following Hornstein's (2001) proposal that a reflexive and a pronoun are a residue of A movement. This is not a novel idea. The close tie between binding and movement has already been noted early on in mid-seventies. Hornstein argues that a reflexive is a residue of A movement and an NP trace can be spelled out as a pronoun when a movement is prohibited (see Hornstein 2001 for extensive discussion).

On the SC analysis in concert with a view of a reflexive as an NP-trace, we may assume that (15)c ((18)a here) starts like (18)b.

- (18) a. Mary shouted herself hoarse
 b. Mary shouted Mary hoarse

(19) shows how the derivation proceeds.

- (19) Mary T [_{VP} self [_{VP} Mary v [_{VP} shouted [_{TP} [Mary]self [_T [_{AP} [Mary]self
 θ/θ/Case Case θ/θ θ
 hoarse]]]]]]⁴

By assumption the *self* form is attached to Mary as a Case holder. The resultative subject [*Mary*]self merges with its resultative predicate *hoarse* getting a theta role. Then *self* checks the accusative Case. *Mary* raises to Spec of TP. It gets its nominative Case checked. It is reminiscent of a so-called Raising construction (a.k.a. ECMs). This technical implementation may be a little bit tricky to see it immediately. Yet the relevant point is that the surface subject *Mary* starts with the predicate *hoarse*. In its way to Spec of TP, *Mary* should stop at Spec of vP. *Mary* is manifested as a reflexive *herself* for a Case reason.

It is worth noting that we do not stipulate any special status for this reflexive as a fake reflexive in the sense of Simpson and Levin and Rappaport Hovav. It sounds pretty construction-specific and is not even independently motivated. On the present analysis, this fake reflexive is merely a by-product of derivation on a par with a regular reflexive in Raising as in (20).

- (20) a. Mary thinks herself to be kind
b. Mary thinks Mary to be kind

Now look at (5) with a bound possessive pronoun, as repeated as (21).

- (21) a. *John cried his eyes
b. *John cried red
c. John_i cried his_{i/*j} eyes red

Again an intransitive verb *cry* cannot occur with an internal argument *his eyes* and a resultative predicate *red* alone respectively in (21)a and (21)b. It should come with both of them together as shown in (21)c. Therefore, a verb *cry* takes a SC *his eyes red* as a whole rather than one at a time.

On the SC approach in conjunction with Kayne's (2001) doubling structure, building on Uriagereka (1995) where clitic and double start out together. Kayne assumes that the antecedent and the pronoun are merged together and the antecedent moves into a surface position out of a doubling structure leaving the pronoun behind. With this in mind, in (21)c *John* merges with the pronoun *his* first, thereby obtaining a coreferential reading between them. *John* moves out of the doubling structure [*John his eyes*] into a subject position getting an extra theta role from the matrix verb *cry* as given in (22):

- (22) a. John_i cried his_{i/*j} eyes
b. John_i cried [_i his_i eyes red]

To recap we have corroborated the SC analysis via presenting the examples of the RC with a reflexive and a bound pronoun where they must be bound by a matrix subject. On the SC analysis, the necessary bound reading of a reflexive and a pronoun by a subject ensues without relying on any additional stipulation.

5. Two Types of RC

Here I propose that the RC is structurally similar to Raising and Control (see S-M Hong forthcoming for further discussions). Depending on a matrix verb, the RC with an intransitive verb fits into Raising and the one with a transitive verb fits into Control (Dowty 1979, Simpson 1983, Carrier and Randall 1992, and Bowers 1997).

5.1 Raising RC

In the Raising RC, following Lasnik and Saito's (1991) raising account, the postverbal argument *their Nikes* in (23)a is assumed to get a theta role from the resultative predicate *threadbare* and get its Case checked by the matrix v the same way as the embedded subject *Mary* does in (23)b.

- (23) Raising
- a. The joggers ran their Nikes threadbare
 θ/acc
 - b. John believed Mary to be kind
 θ/acc

5.2 Control RC

In the case of control RC, in line with Hornstein's (2001) suggestion of Control as movement, the postverbal argument *the metal* in (24)a is believed to get two theta roles: one from the resultative predicate *flat* and the other from the verb *hammer* and get its Case checked by the matrix v in a similar fashion like *Mary* in (24)b.

- (24) Control
- a. John hammered the metal flat
 $\theta/\theta/\text{acc}$
 - b. John persuaded Mary to leave
 $\theta/\theta/\text{acc}$

6. Ambiguity between Subject Resultative and Object Resultative

In section 3.2, I have proposed that as for the Korean RC a SC should be considered as an adjunct rather than a complement grounded on the observation that it lacks selectional restriction. It enables us to assume that an SC is attached to a different position within the verbal domain. Logically it is possible to have an ambiguous RC with one surface form. The ambiguous example is given in (25).

- (25) John-un Mary-lul cilwuha-key ccochatani-ess-ta
John-top Mary-acc bored-key chase-past
'John_i chased Mary_j so that he_i/she_j became bored'
(Cormack and Smith 1999)

The resultative predicate *cilwuha-* ‘bored’ can be predicated of either a subject *John* or an object *Mary*. The difference in readings may be related to a different history of derivation as offered in (26).

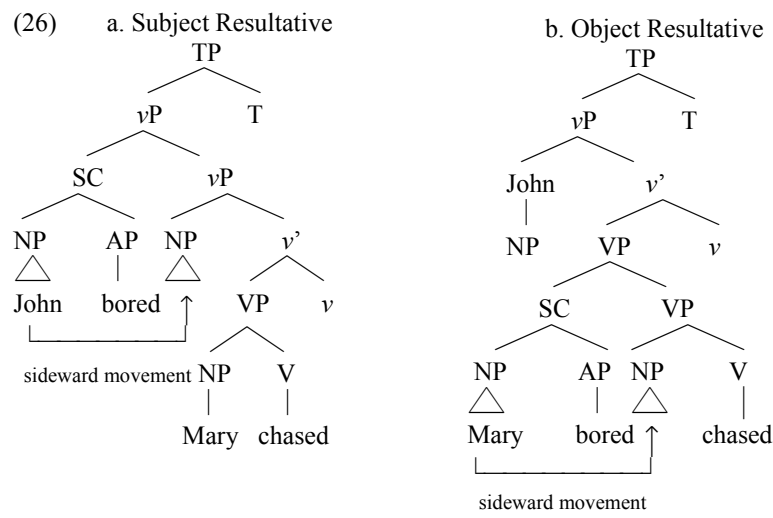

The Subject Resultative in (26)a engages a vP adjunction. The SC subject is *John*. *John* merges with the resultative predicate *cilwuha-* ‘bored’ getting a first theta role and sideward moves to Spec of vP receiving a second theta role, that is an agent role.⁵ Then it raises to Spec of TP getting its nominative Case checked. On the other hand, the Object Resultative in (26)b involves a VP adjunction. The SC subject is *Mary*. First *Mary* merges with the resultative predicate *cilwuha-* ‘bored’ receiving a first theta role and then sideward moves to an object of the verb *cocchatani-* ‘chase’ getting an extra theta role, namely the persuadee. Finally it moves to Spec of vP getting its accusative Case checked.

Depending on the attachment site, we can have either the Subject Resultative in (26)a or the Object Resultative in (26)b. However, as we have noted in section 2.1, English does not allow the Subject Resultative in (27).

- (27) *John hammered the metal tired
 ‘John hammered the metal so that he became tired’

Unavailability of the Subject Resultative may be tied up with a complement status of the SC in the English RC. The resultative subject cannot raise to a matrix subject position across an matrix object position since it causes a violation of the Shortest Movement Condition as shown in (28).

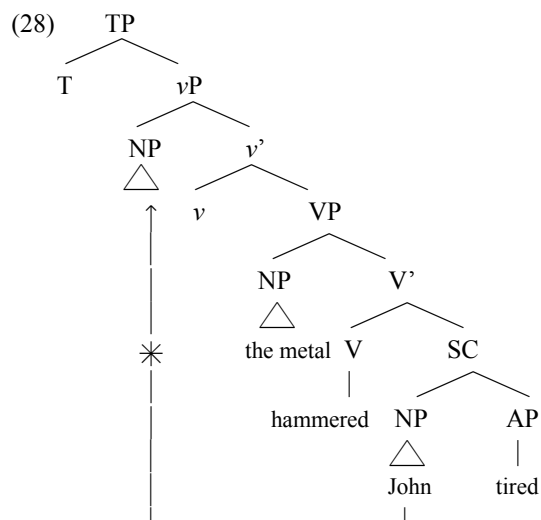

7. Conclusion

The analysis presented in this paper revolves around a different treatment of a SC in the RC in English and Korean. It is argued that a SC of the RC is a VP complement for English whereas it is a vP/VP adjunct for Korean because English demonstrates the selectional restriction of resultative predicates while Korean does not. Under this analysis, we can explain why English prevents the Subject Resultative while Korean allows both the Object and the Subject Resultative. English has only one attachment site of a SC, namely a VP complement and a resultative subject cannot raise to a subject position over an object position without a violation of minimality. On the other hand, Korean allows the Subject Resultative when a SC is attached to a vP and a resultative subject can raise to subject not violating minimality. This kind of account of analysis complies with the derivational approach to syntactic relations.

Notes

¹ The resultative subject *kumsok* 'metal' can be marked either with the accusative Case *-ul* or the nominative Case *-i*.

² It is an ongoing debate whether Korean has a distinct category of adjective or whether Korean lacks an adjective category in its entirety and hence should be classified as stative verb.

³ Williams (1980, 1983) claims that a secondary predication relation should be represented in a flat syntactic structure using a co-indexation mechanism.

⁴ The notation indicates that 'θ' means a theta role that an argument receives and 'Case' means that its Case feature is checked.

⁵ We adopt sideward (interarboreal) movement developed by Nunes (1995, 2001) and Hornstein (2001) (see Nunes 1995, 2001 and Hornstein 2001 for details).

References

- Carrier et al. 1992. The argument structure and syntactic structure of resultatives. *Linguistic Inquiry*, **23**. pp: 173-234.
- Chomsky, N. 1995. *The Minimalist Program*. Cambridge, Mass.:Blackwell.
- Dowty, D. 1979. *Word Meaning and Montague Grammar-The Semantics of Verbs and Times in Generative Semantics and in Montague's PTQ*. Dordrecht: Reidel Publishing Company.
- Hong, S-M. Forthcoming. "Exceptional" Case Marking and Resultative Constructions. Ph.D. Dissertation, University of Maryland, College Park.
- Hornstein, N. 2001. *Move! A Minimalist Theory of Construal*. Cambridge, Mass.:Blackwell.
- Hornstein et al. 1987. Predication and PRO. *Language*, **63**. pp. 23-52.
- Kim, J-B. 1999. The syntax and semantics of English and Korean resultatives. *NELS*, **31**. pp: 137-151.
- Kim et al. 1997. A crosslinguistic perspective on resultative formation. In R. Blight and M. Moosally, (eds.) *Texas Linguistic Forum*, **38**. pp: 189-204.
- Nunes, J. 1995. The Copy Theory of Movement and Linearization of Chains in the Minimalist Program. Ph.D. Dissertation, University of Maryland, College Park.
- Levin et al. 1995. *Unaccusativity; At the Syntax-Lexical Semantics Interface*. Cambridge, Mass.:MIT Press.
- Pesetsky, D. 1995. *Zero Syntax*. Cambridge, Mass:MIT Press.
- Simpson, J. 1986. *Resultative attributes*. ms., Lexicon Project Seminar, February, MIT Cambridge, Massachusetts.
- Tenny, C. 1994. *Aspectual Roles and the Syntax-Semantics Interface*. Kluwer Academic Publishers.
- Wechsler et al. On Resultative Predicates and Clauses: Parallels Between Korean and English. In *Language Sciences*, **23**. pp: 391-423.

Soo-Min Hong
 Department of Linguistics
 University of Maryland
 1401 Marie Mount Hall
 College Park, MD 20742
 USA
 smhong@umd.edu
 soomhong@hotmail.com

Cross-Category Phonological Contrast as a Result of Morphological Marking

Cristian Iscrulescu

University of Southern California

1. Introduction

Recent research on the phonological properties of lexical categories has revealed the existence of asymmetries between nominal and verbal categories. The asymmetries observed have been attributed to various factors, such as faithfulness properties intrinsic to the respective categories (Smith 1999, 2001) or paradigmatic effects (Cable 2003).

The present paper acknowledges the existence of the above asymmetries, with emphasis on forms inflected for morpho-syntactic categories. It is argued that phonological asymmetries that hold between categories (verbs and nouns) are attributable to a large extent to the properties of verbal and nominal inflections, in that the realization of the former in outputs can override phonological requirements that otherwise observed in the language and in nouns in particular. Thus it is verbal, rather than nominal inflection that resists neutralization processes and can lead to a larger number of contrasts.

To illustrate the issue at hand, consider the behavior of Old Saxon nouns and verbs. In Old Saxon (Gallée 1910, Holthausen 1921, Cathey 2000), the contrast between the singular and plural (expressed by the suffix $-u_{PL}$) in the nominative-accusative is preserved or neutralized function of the prosodic properties of the stem:

- | | | |
|--------------------------------------|---------|---------------------------------------|
| (1) $glas_{SG} \sim glas-u_{PL}$ | ‘glass’ | Contrast preserved in ‘light’ stems |
| $barn_{SG} \sim barn-\emptyset_{PL}$ | ‘child’ | Contrast neutralized in ‘heavy’ stems |

In verbs, however, the contrast between 1st person singular agreement ($-u_{AGR-1}$) and other members of the paradigm is always enforced, irrespective of stem type:

- | | | | |
|--|----------------|--------------|-----------------------------------|
| (2) $sih-u_{AGR-1} \sim sih-is_{AGR-2}$ etc. | ‘I/you see’ | ‘light’ stem | } Contrast
always
preserved |
| $u_{AGR-1} \sim wir\delta-is_{AGR-2}$ etc. | ‘I/you become’ | ‘heavy’ stem | |

The paper is organized as follows. Section 2 presents other instance of asymmetries between inflected outputs. The case discussed in detail is the one of Old Saxon nouns versus verbs, for which an optimality-theoretic account is offered in Section 3 using Morpheme Realization constraints. Finally, Section 4 discusses the results and states the conclusions of the paper.

2. Phonological asymmetries between inflected categories

Apart from the Old Saxon case, which will be discussed in detail in the following section of the paper, there are a number of other cases where inflected lexical categories display asymmetries with respect to their phonological expression in that nominal categories (nouns and adjectives) are more constrained phonologically than verbs. In this section I will review a few such cases, as evidence for the fact that the observed phenomenon is well-attested cross-linguistically.

In Tswana, (Coetzee 2003) underlying nasal segments are sometimes not parsed when they are the exponent of number in nouns (3), but are always parsed when they express verbal inflection such as first person singular object agreement (4):

(3) Underlying nasal inflection not parsed in nouns:

$/N_{SG,+peo}_{ROOT}/ \rightarrow peo$	‘seed’
$/N_{SG,+tl^hase}_{ROOT}/ \rightarrow tl^hase$	‘spark’
$/N_{SG,+ts^hipi}_{ROOT}/ \rightarrow ts^hipi$	‘iron/metal’

(4) Underlying nasal inflection parsed in verbs:

$/go_{INF,+N_{1ST.OBJ,+sega}_{ROOT}}/ \rightarrow [gonts^hega]$	‘to cut me’
$/go_{INF,+N_{1ST.OBJ,+direla}_{ROOT}}/ \rightarrow [gontirela]$	‘to do for me’
$/go_{INF,+N_{1ST.OBJ,+fenyha}_{ROOT}}/ \rightarrow [gomp^henya]$	‘to conquer me’

In Modern Hebrew (Ussishkin & Graf 2002), complex codas are generally disallowed, at least in native words, and in particular in nouns. However, complex codas do occur in the verbal domain in the second person feminine singular of the past tense, as a result of affixation:

(5) Complex codas attested in verbs:

$/baxa\gamma_{ROOT-PAST}+t_{2ND.SG.FEM.}/ \rightarrow [baxa\gamma t]$	‘you chose, 2 nd fem. sing.’
$/xalam_{ROOT-PAST}+t_{2ND.SG.FEM.}/ \rightarrow [xalam t]$	‘you dreamed, 2 nd fem. sing.’
$/katav_{ROOT-PAST}+t_{2ND.SG.FEM.}/ \rightarrow [katav t]$	‘you wrote, 2 nd fem. sing.’

On the other hand, complex codas are repaired by epenthesis in nouns:

(6) Complex codas repaired in nouns:

/film/ → [fɪlɪm], [fɪlem]	‘film’
/popkoɣn/ → [popkoɣen]	‘popcorn’
/mexanizm/ → [mexanizem]	‘mechanism’

Another type of contrast between inflected categories is found in Mandarin Chinese (Feng 2003), where adjective reduplication is more constrained than verb reduplication in that the latter allows for more (morphologically conditioned) patterns.

(7) Adjective reduplication: AB → AABB

/RED + kǎntçiq/ → [kǎnkǎntçiq̩tçiq̩]	‘clean – clean (intensified)’
/RED + m’ínpái/ → [m’ínm’ín páipái]	‘clear – clear (intensified)’

(8) Verb reduplication: AB → ABAB, AAB

/RED + tʃɪdian/ → [tʃɪtʃǎntʃɪtʃǎn]	‘comment – comment here and there’
/RED + tʃɪfan/ → [tʃɪtʃɪfan]	‘eat-meal – eat a little bit’

The examples given so far show that there are asymmetries between inflected verbal and nominal categories in point of phonological behavior, as summarized in (9):

(9) Examples of verbal-nominal phonological asymmetries

- (a) verbs preserve underlying segmental contrast better than nouns (Old Saxon, Tswana)
- (b) verbs preserve more marked structure (complex clusters in potential coda position) than nouns (Modern Hebrew)
- (c) verbs allow for more diverse, less constrained reduplication patterns than adjectives (Mandarin Chinese)

3. Inflected verb-noun asymmetries in Old Saxon

In Old Saxon nouns Gallée 1910, Holthausen 1921, Cathey 2000), the high vowel exponent of the plural nominative-accusative is realized with ‘light’ CVC stems (10a.), but deletes after ‘heavy’ CVCC or CV: stems (10b):

(10)

<i>Singular</i>	<i>Plural</i>	<i>Gloss</i>
a. glas /glas/	gla.su /glas-u _{Pl} /	'glass'
blad /blad/	bla.du /blad-u _{Pl} /	'leaf'
b. barn /barn/	barn *barnu /barn-u _{Pl} /	'child'
wi:f /wi:f/	wi:f *wi:fu /wi:f-u _{Pl} /	'wife'

} 'Light' stems
} 'Heavy' stems

However, in verbs the high vowel exponent of the first person singular agreement is retained in outputs irrespective of stem type:

(11)

<i>1st person singular</i>	<i>Gloss</i>
a. bi.ru /bir-u _{AGR-1} /	'I bear'
si.hu /sih-u _{AGR-1} /	'I see'
b. wir.ðu /wirð-u _{AGR-1} /	'I become'
bin.du /bind-u _{AGR-1} /	'I bind'

} 'Light' stems
} 'Heavy'

All the examples above crucially involve the expression of inflectional categories and are hard to attribute solely to properties of the verbal or nominal stem as such – it looks that in inflected forms it is verbs, and not nouns that can allow for more expression of categories in outputs.

Before we present an analysis of the Old Saxon phenomena, let us state some descriptive facts. Old Saxon, like West Germanic in general (and Old English in particular) is a weight-sensitive, moraic trochee system (Hayes 1995, Bermúdez-Otero 2001 etc.). As in moraic trochee systems in general, uneven (HL or H) trochees are avoided as a rule. Thus underlying high vowel suffixes (/u/) delete in nouns, as expected, whenever their presence in outputs threatens to lead to an HL or H trochee. Descriptively, /u/ is deleted after 'heavy' CVCC or CV: stems. This can be easily seen in the inflectional paradigm of nouns:

(6) Old Saxon nominal paradigm

a. 'Light' stems (neuter, a-declension)

<i>Singular</i>	<i>Plural</i>
N. A. glas 'glass'	N. A. glas-u
G. glas-es	G. glas-o
D. glas-e	D. glas-um

b. 'Heavy' stems (neuter, a-declension)

<i>Singular</i>	<i>Plural</i>
N. A. barn 'child'	N. A. barn /barn-u _{Pl} /
G. barn-es	G. barn-o
D. barn-e	D. barn-um

The verb-noun asymmetry can be clearly seen if we examine the two ('light' stem and 'heavy' stem) verbal paradigm, where the first person singular morpheme is faithfully parsed:

(7) Old Saxon verbal paradigm

a. 'Light' stems

<i>Singular</i>	<i>Plural</i>
1 st bir-u 'become'	1 st } ber-ad
2 nd bir-is	2 nd }
3 rd bir-id	3 rd }

b. 'Heavy' stems

<i>Singular</i>	<i>Plural</i>
1 st wirð-u 'become'	1 st } werð-ad
2 nd wirð-is	2 nd }
3 rd wirð-id	3 rd }

As a first step in the analysis, note that the inflectional high vowel suffix (-*u*) rescues the even trochee in 'light' stems (7a.), but can compromise it in 'heavy' stems (7b.):

(7)

- a. /glas-u/ → [(glá.su)] **(LL)**
 b. /barn-u/ → *[(bár.nu)] **(HL)**
 [(bárn)] **(H)**

In optimality-theoretic terms, the constraint that enforces the even trochee is EVEN-TROCHEE (Prince 1990, Hayes 1995):

- (8) EVEN-TROCHEE: (LL) › (HL), (H) 'Even (LL) trochees are more harmonious than uneven (HL, H) trochees'

Also, the (non)deletion of the underlying high vowel morphological exponent is indicative of the fact that we are apparently dealing with an interaction between prosody and phonotactics. The constraint militating for high vowel deletion is *PK/u (Prince & Smolensky 1993/2004, Iscrulescu 2003):

- (9) *PK/u 'No high vowel syllable peaks.'

If we consider the behavior of 'light' stem nouns, we can note that EVEN-TROCHEE has to dominate *PK/u, as can be seen from Tableau (10) below:

(10) EVEN-TROCHEE » *PK/u ('light' stem nouns)

/glas-u _{PL} /	EVEN-TROCHEE	*PK/u
a. \mathcal{C} (glá.su _{PL})		*
b. (glásØ _{PL})	*!	

On the other hand, in 'heavy' stem nouns the high vowel affix is not parsed. This means that the deletion constraint *PK/u has to dominate the faithfulness constraint that enforces parsing of high vowels MAX-u:

(11) *PK/u » MAX-u ('heavy' stem nouns)

barn-u _{PL} /	*PK/u	MAX-u
a. \mathcal{C} (bárnØ _{PL})		*
b. (bár.nu _{PL})	*!	
c. (bár).nu _{PL}	*!	

Tableaux (10) and (11) yield the constraint ranking in (12), which, as we shall see, will have to be revised so as to accommodate the behavior of verbs:

(12) Summary ranking for Old Saxon (to be revised):

EVEN-TROCHEE » *PK/u » MAX-u

If we now consider Old Saxon verbs, where the exponent of the first person Agreement (-u_{AGR-1}) is realized irrespective of prosodic properties, we note that MAX-u will have to be top-ranked:

(13) MAX-u, EVEN-TROCHEE » *PK/u ('heavy' stem)

/bind-u _{AGR-1} /	MAX-u	EVEN-TROCHEE	*PK/u
a. \mathcal{C} (bín.du _{AGR-1})		*	*
b. (bíndØ _{AGR-1}) ¹	*(!)	*(!)	

The results in (12) and (13) are contradictory, because MAX-u is ranked in two different places in the hierarchy (over *PK/u in verbs, but under *PK/u in nouns). In order to solve the puzzle, we have to take into account the morphological exponence of the high vowel /u/, which is different in nouns and verbs. In order to do that, I propose that Morpheme Realization² constraints be used. The definition of Morpheme Realization employed in this paper is based on the correspondence between the morphological and phonological structure of outputs:

(14) Morpheme Realization

REALIZE-MORPHEME: A morpheme present in the morphological structure of an output has a correspondent in the phonological structure of that output. (cf. Walker 2000, Walker & Feng to appear, Iscrulescu 2003)

Differences between the behavior of inflectional categories can be captured if we relativize Morpheme Realization in order to take into account the specificity of nominal and verbal inflection (number versus agreement):

(15) Category-specific Morpheme Realization

REALIZE-NUMBER: The number morpheme in the morphological structure of an output has a correspondent in phonological structure of that output.

REALIZE-AGREEMENT: The agreement morpheme in the morphological structure of an output has a correspondent in phonological structure of that output.

In (16) below it is shown how a specific Morpheme Realization constraint (REALIZE-NUMBER) is assessed:

(16) Assessing Morpheme Realization

REALIZE-NUMBER satisfied:

Morphological Structure NOUN-PL
 Phonological Structure NOUN-u_{PL}

REALIZE-NUMBER violated:

Morphological Structure NOUN-PL
 Phonological Structure NOUN-Ø_{PL}

Thus the generic I-O faithfulness constraint MAX-u is replaced by REALIZE-NUMBER in nouns and by REALIZE-AGREEMENT in verbs.

With these provisions, we can note that in verbs the realization of the first person singular (Agreement) suffix is more stringent than the need for even trochees, which can be seen in (17):

(17) REALIZE-AGREEMENT, EVEN-TROCHEE » *PK/u (verbs)

/bind-u _{AGR-1} /	REALIZE-AGREEMENT	EVEN-TROCHEE	*PK/u
a. φ (bín.du _{AGR-1})		*	*
b. (bíndØ _{AGR-1})	*(!)	*(!)	

In nouns however, the realization of the high vowel plural morpheme can be overridden by prosodic requirements:

(18) EVEN-TROCHEE » *PK/u » REALIZE-NUMBER

The final constraint ranking for Old Saxon thus emerges:

(19) REALIZE-AGREEMENT, EVEN-TROCHEE » *PK/u » REALIZE-NUMBER

To summarize, there is an asymmetry between the phonological behavior of inflected nouns and verbs in Old Saxon that manifests itself in that in verbs the high vowel exponent of agreement is always realized, irrespective of general prosodic properties, while the realization of the homophonous number affix in nouns is contingent upon prosody. More generally, it seems that the realization of verbal categories are more stringent than the realization of verbal categories, which can be captured by the constraint hierarchy in (20):

(20) REALIZE-VERB.CAT. » (PHONOCONSTRAINTS) » REALIZE-NOM.CAT.

In (20), REALIZE-VERB.CAT. and REALIZE-NOM.CAT. are the relevant Morpheme Realization constraints for verbal and nominal categories, respectively, and PHONOCONSTRAINTS is a cover label for the phonological markedness constraints active in the language.

4. Summary and conclusion

The results of our analysis support the view according to which in inflected verbs there is more faithfulness to morphologically specified affixes than in inflected nominals. In the particular case of Old Saxon, the high vowel first person agreement morpheme (/u_{AGR-1}/) is faithfully parsed irrespective of the consequences on the general prosodic properties of the language (even trochees), whereas the homophonous number morpheme in nouns (/u_{PL}/) deletes if its presence in outputs would lead to uneven trochees.

We have proposed that the observed effects can be attributed to the activity specific morpheme realization constraints, and in the case under analysis verbal agreement is more stringent than nominal number. Old Saxon (and other languages with similar noun-verb morphologically conditioned asymmetries) provide an example of cross-category (noun-verb) morpheme realization hierarchy of the type:

(21) REALIZE-VERB.CAT. » (PHONOCONSTRAINTS) » REALIZE-NOM.CAT.

This result is at first blush different from other accounts of verb-noun asymmetries, in particular the ones of Smith (1999 and 2001), who finds that it is nouns, and not verbs that qualify as a strong position and allow for more faithfulness and less neutralization. Nevertheless, our results are not necessarily

a counterargument to Smith's claims, because while Smith considers primarily uninflected forms, our account focuses on inflected categories and attributes the asymmetry to specific realizational properties of the inflectional categories in question.

The question remains open as to the source of the inflected noun-verb asymmetry. In a study of Tswana, Coetzee (2001) speculates that referential categories, like verbal agreement, are more stringent than non-referential ones, like nominal number. Therefore the former must not be left unparsed in outputs (which requirement is enforced by MAXREF, a constraint that states that categories specified in the input with a referential index must have a correspondent in outputs).

Although Coetzee's hypothesis may seem stipulative to a certain extent, we believe that the observed asymmetries can indeed be accounted for from a functional, yet different perspective. As concerns agreement in verbs, one can note that this category is relational from a syntactic point of view as is not inherent in verbs in the same way number is inherent in nouns. If left unparsed in nouns, the category of number can still be recovered in discourse by means of other members of the nominal projection, such as determiners or adjectives, that can provide the relevant morpho-syntactic information although number is not realized in the noun due to phonological requirements. In contrast, due to its relational, cross-phrasal nature (in the sentence the verb functions as the central, obligatory element that relates the subject and the object) verbal agreement is more resilient, especially in a pro-drop language like Old Saxon. This potentially translates into more faithfulness in verbal inflected forms than in the nominal counterparts.

The present paper represents a step towards a research program aimed at studying and accounting for phonological asymmetries between inflected lexical categories. While such asymmetries can be shown to exist, more work remains to be done to offer a general account of their causes.

Notes

¹ A third candidate with final syllable extrametricality like (*bín*).*du*_{AGR-I} is ruled out by PARSE-SYLL: Syllables are parsed by feet (Prince & Smolensky 1993/2004). For simplicity, since it is low-ranked, PARSE-SYLL and the candidate that violates it are considered.

² Morpheme realization constraints have been stated and employed, in some form or another, by Samek-Lodovici (1992, 1993), Gnanadesikan (1997), Kurisu (2001) etc.

References

- Bermúdez-Otero, Ricardo. 2001. Underlyingly nonmoraic consonants, faithfulness, and sympathy. Manuscript. University of Manchester
- Cable, Seth. 2003. Optimal Paradigms and Phonological Noun-Verb Dissimilarities. Manuscript. MIT.

- Coetzee, Andries W. 2001. Nasal-only syllables in Tswana. In Graham Horwood and Se-Kyung Kim (eds.) *RuLing Papers 2: Working Papers of Rutgers University*. New Brunswick: Department of Linguistics, Rutgers University. 1-20.
- Feng, Guanjun Bella. 2003. Verb versus Adjective Reduplication in Mandarin. Paper presented at 2003 Linguistic Society of American Annual Meeting, Atlanta.
- Gallée, Johan Hendrik. 1910. *Altsächsische Grammatik*. Halle: Max Niemeyer.
- Gnanadesikan, Amalia E. 1997. *Phonology with Ternary Scales*, Doctoral Dissertation. Amherst: University of Massachusetts [ROA-195]
- Hayes, Bruce. 1995. *Metrical Stress Theory*. Chicago and London: Chicago University Press.
- Holthausen, Ferdinand. 1921. *Altsächsisches Elementarbuch*. Heidelberg: Carl Winter's Universitätsbuchhandlung.
- Iscrulescu, Cristian. 2003. Realize-Morpheme: One Constraint, or a Family? In Brian Agbayani et al. (eds.) *Proceedings of WECOL 2003*. Fresno, California: California State University. 61-71.
- Kurisu, Kazutaka. 2001. *The Phonology of Morpheme Realization*, Doctoral Dissertation, University of California, Santa Cruz [ROA-490]
- McCarthy, John J. 2002. Optimal Paradigms. Manuscript. Amherst: University of Massachusetts
- Prince, Alan. 1990. Quantitative Consequences of Rhythmic Organization. In M. Ziolkowski, M. Noske & K. Deaton (eds.) *Papers from the Chicago Linguistic Society* 26:2. 355-398.
- Prince, Alan; Smolensky, Paul. 1993/2004. *Optimality Theory: Constraint interaction in generative grammar*. London: Blackwell [Originally published as Technical Report CU-CS-696-93, Department of Computer Science, University of Colorado at Boulder, and Technical Report TR-2, Rutgers Center for Cognitive Science, Rutgers University, New Brunswick, NJ, April 1993]
- Samek-Lodovici, Vieri. 1992. Universal Constraints and Morphological Geminatio: A Crosslinguistic Study. Manuscript. Brandeis University.
- Samek-Lodovici, Vieri. 1993. A Unified Analysis of Crosslinguistic Morphological Geminatio. *CONSOLE Proceedings*.
- Smith, Jennifer L. 1999. Noun faithfulness and accent in Fukuoka Japanese. In Sonya Bird, Andrew Carnie, Jason D. Haugen, and Peter Norquest, eds., *Proceedings of WCCFL XVIII*. Somerville, MA: Cascadilla Press. 519-531.
- Smith, Jennifer L. 2001. Lexical category and phonological contrast. In Robert Kirchner, Joe Pater, and Wolf Wikely, eds., *Papers in Experimental and Theoretical Linguistics 6: Workshop on the Lexicon in Phonetics and Phonology*. Edmonton: University of Alberta. 61-72.
- Ussishkin, Adam; Graf, Dafna. 2002. Loanword Phonology in Modern Hebrew. Paper presented at the Workshop on The Integration of Foreign Words, *Deutsche Gesellschaft für Sprachwissenschaft*, Mannheim, Germany.
- Walker, Rachel 2000. Nasal reduplication in Mbe affixation. *Phonology* 17. 65-115.
- Walker, Rachel; Feng Guanjung (Bella). To appear. A ternary model of morphology-phonology correspondence. To appear in *Proceedings of WCCFL 23*.

Cristian Iscrulescu
 University of Southern California
 Department of Linguistics
 iscrules@usc.edu

The Interpretation of Pronouns and Reflexives in Picture Noun Phrases: Effects of Non-structural Factors

**Elsi Kaiser, Jeffrey T. Runner,
Rachel S. Sussman & Michael K. Tanenhaus**
University of Rochester

1. Introduction*

We discuss three psycholinguistic experiments that investigate the interplay of syntactic and semantic/discourse factors on the interpretation of pronouns and reflexives in picture NPs in English. These experiments form part of a larger project investigating the contributions of syntactic, pragmatic and semantic information to the interpretation of pronouns and reflexives in English (see e.g. Runner, Sussman & Tanenhaus 2002, 2003, to appear), with plans to extend the research into other structures in English as well as into other languages. As a whole, this research aims to provide a window into the interactions among structural, pragmatic and semantic factors in language processing.

The experiments we describe test the hypotheses (i) that “source-of-information” referents can antecede BT-incompatible reflexives in picture NPs (Kuno 1987), and (ii) that “perceiver-of-information” referents can antecede BT-incompatible pronouns (see Tenny 2003). The results of two off-line studies and an eye-tracking experiment support both of these hypotheses. The results show that discourse/semanticⁱ factors interact with Binding Theory, but affect pronouns with local antecedents more than reflexives with non-local antecedents.

The structure of the paper is as follows. In this section, we will review the basics of Binding Theory and discuss some well-known areas where Binding Theory runs into trouble, in particular so-called picture noun phrases, which are the main focus of this paper. Sections 2 and 3 present the results of two ‘off-line’ experiments that investigate the effects of the source/perceiver manipulation on the antecedents chosen for pronouns and reflexives. In Section 4, we present the results of the eye-tracking study, and we discuss the results and their implications in Section 5.

1.1 Binding Theory

Pronominal and reflexive noun phrases in English have a nearly complementary distribution (ex. (1)), and Principles A and B of classic Binding Theory aim to provide a structural account of this complementarity (e.g. Chomsky 1981, 1986).

- (1) a. Julius_i saw him_{*i/j} / himself_{i/*j}.
 b. Julius_i saw a picture of him_{*i/j} / himself_{i/*j}.
- (2) A: An anaphor is bound in a local domain (roughly, a sentence or a possessed NP).
 B: A pronoun is free in a local domain.

However, it is well-known that there are certain areas that traditional Binding Theory is unable to account for. Reflexives can be grammatical without being locally bound (ex. (3)), and pronouns can be grammatical even with local antecedents (ex. (4)). In light of these kinds of data, a number of researchers have argued that the interpretation and acceptability of pronouns and reflexives can be modulated by semantic and discourse factors (e.g. Cantrall 1974, Kuno 1987, Zribi-Hertz 1989, Pollard & Sag 1992, Reinhart & Reuland 1993, Tenny 1996, Tenny 2003).

- (3) a. Bismarck's impulsiveness has, as so often, rebounded against **himself**. (quoted in Zribi-Hertz 1989)
 b. Warren says it's a good time to be an astrophysicist. Fifteen years ago, "we were starved for observations," he says. Now it's the opposite: Theorists like **himself** are drowning in data from modern telescopes. (from The New Mexican newspaper in Santa Fe, NM, 6/28/04)
- (4) a. Poor John. Now he's got an ambitious little snake next to **him**. (www.freerepublic.com/~regulator/in-forum)
 b. Except he could not throw the ball because he was getting tackled. He was about to hit the ground. He had to do something else. He saw someone behind **him**. He flipped the ball in desperation. (www.wildbillschiefs.com/news/data/604.txt)

1.2 Picture noun phrases

Picture NPs (e.g. *picture of her/herself*) constitute one of the best-known cases showing clear discourse/semantic effects for both pronouns and reflexives (e.g. Kuno 1987, Pollard & Sag 1992, Reinhart & Reuland 1993, Keller & Asudeh 2001, Tenny 2003). Let us first consider reflexives. Examples such as (5a) and (5b) illustrate the impact of discourse/semantic factors. No purely structural theory of binding can capture the fact that the antecedent of a reflexive can occur in another sentence, yet (5a) is acceptable. The unacceptability of (5b)

indicates that point of view is relevant: (5a), with an acceptable free reflexive, is from John's point of view, whereas (5b) is not. (We follow Reinhart & Reuland (1993) in using the term 'logophor' for reflexives in picture NPs, but remain agnostic on the question of how similar picture NP reflexives are to true logophors in African languages such as Ewe, see Clements 1975, Hagège 1974).

(5) [examples from Pollard & Sag 1992]

- a. John_i was going to get even with Mary. [That picture of him_i/himself_i] in the paper would really annoy her, as would the other stunts he had planned.
- b. Mary was quite taken aback by the publicity John_i was receiving. [That picture of him_i/*himself_i] in the paper would really annoy her, as would the other stunts he had planned.

More generally, Kuno (1987) argues that factors like point of view, awareness and semantic roles influence whether a given entity can act as the antecedent for a logophoric reflexive (see also Pollard & Sag 1992, Reinhart & Reuland 1993). In this paper, we focus on the hypothesis in (6a), based on Kuno's claims (see his example (6b)) and drawing on Sells (1987)'s definition of *source* as the one who is the intentional agent of the communication.

- (6) a. BT-incompatible reflexive can refer to sources.
- b. John heard from Mary about a damaging rumor about [?]herself/[?]her (that was going around). (Kuno 1987:175)

The hypothesis in (6a) provides an interesting counterpart to claims that have been made regarding BT-incompatible pronouns. Let us start by considering the examples in (7). From the perspective of standard BT, the pronouns in (7a,c) (examples based on Reinhart & Reuland 1993) should not be grammatical since they are c-commanded by a local antecedent.

- (7) a. Lucie_i saw the picture of her_i. b.* Lucie_i took the picture of her_i.
- c. Max_i heard the story about him_i. d. * Max_i told the story about him_i.

Tenny (2003) calls these kinds of pronouns short-distance pronouns (SDPs) and notes that "verbs that provide a sentient, perceiving antecedent are especially conducive to SDPs" (Tenny 2003:42). She also observes that SDPs "in representational contexts [...] are especially felicitous with perceiving subjects" (Tenny 2003:42). So, for pronouns we test the hypothesis in (8).

- (8) BT-incompatible pronouns can refer to perceivers.

Although Kuno and Tenny do not comment on this, the hypotheses in (6a) and (8) are ‘two sides of the same coin’, since verbs like *tell/hear* involve both a source-of-information and a perceiver-of-information. This brings up the possibility that BT-violating pronouns and reflexives will turn out to have a complementary distribution. In other words, it might be the case that these pronouns and reflexives are in complementary distribution—like their ‘regular’ BT-compatible counterparts in non-picture NP constructions—but that the distribution is a different one, and guided by discourse/semantic factors, not the structural configuration of the sentence.

We investigate these issues from an experimental perspective for two main reasons. First, it is well-known that judgments concerning these kinds of constructions are notoriously variable. With an experimental approach, we can manipulate the structural and pragmatic/semantic variables that we want to test, and we collect a set of data from a large group of speakers that can be statistically analyzed to ascertain whether there are any reliable patterns. Second, by using eye-tracking methodology (Experiment 3), we can obtain incremental, real-time information about interpretation. In other words, we get information not only about participants’ final referential choices, but also about what possible referents they consider before they make a choice. These kinds of data can shed further light on the relation between syntactic and semantic/pragmatic factors in anaphora resolution.

2. Experiment 1: Picture Verification

Participants listened to sentences like (9) while looking at scenes containing the two mentioned referents as well as a picture of one of the referents (see Figure 1 below). The task was to indicate whether or not the sentence they hear matches the visual scene, by pressing ‘y’ or ‘n’ on the computer keyboard. By crossing verb type (*told/heard*), anaphoric form (*himself/him*), and visual scene (*picture of subject/picture of object*), we created eight conditions. There were 32 critical items and 32 fillers. Half of the items contained two male referents and half contained two female referents. Twenty-four native English speakers from the University of Rochester community participated in this experiment.

- (9) Peter {told/heard from} Andrew about the picture of {him/himself} on the wall.

2.1 Predictions

Standard BT alone predicts that differences in verb semantics do not lead to differences in binding patterns. More specifically, reflexives are predicted to refer to subjects whereas pronouns are predicted to refer to non-subjects.ⁱⁱ In contrast, according to Kuno and other discourse/semantic approaches, source-of-information influences whether a given entity can act as the antecedent for a

logophoric reflexive, and thus we predict that we should see more non-subject/logophoric responses with *heard* than with *told*. In other words, participants will be more likely to accept non-BT compatible responses (scenes where the picture portrays the character who is in object position) in the *heard* condition than in the *told* condition, since the object is the source-of-information in the *heard* condition.

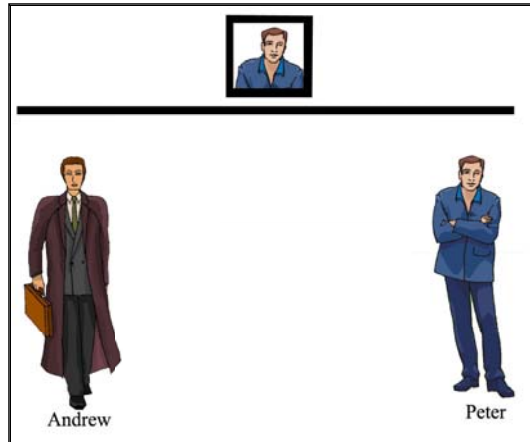

Figure 1. Sample scene for Experiment 1

As for pronouns, according to Tenny, ‘perceiving subjects’ are good antecedents for SDPs, and thus we predict that there will be more subject responses with *heard* than with *told*. In other words, participants will be more likely to accept non-BT compatible responses (scenes where the picture portrays the subject) in the *heard* condition than in the *told* condition, since the subject is the perceiver-of-information in the *heard* condition.

2.2 Results

Let us start by considering the results for reflexives. As Figure 2 shows, there is a general preference to interpret the reflexive as referring to the subject: overall, there are more *yes* answers when the subject is pictured than when the object is pictured. However, especially when the visual scene supports a non-BT compatible interpretation (i.e. when the object is pictured), the verb manipulation seems to influence participants’ responses: There are numerically more non-BT compatible answers (*yes* answers) for reflexives when the object is the source-of-information (with *heard from*) than when the object is the perceiver-of-information (with *told*). Overall, for the reflexive conditions, the effect of the verb manipulation is almost statistically reliable.

Now, turning to the pronoun results, we see that there is a clear effect of the verb manipulation in the predicted direction. More specifically, when presented with a picture of the subject, participants are more likely to accept a non-BT

compatible interpretation of the pronoun when the subject is the perceiver of information (with *heard from*) than when it is the source (with *told*). There are over 50% subject choices with perceiver subjects, but with source subjects, less than a third of the responses are subject choices.

Percentage of 'yes' answers

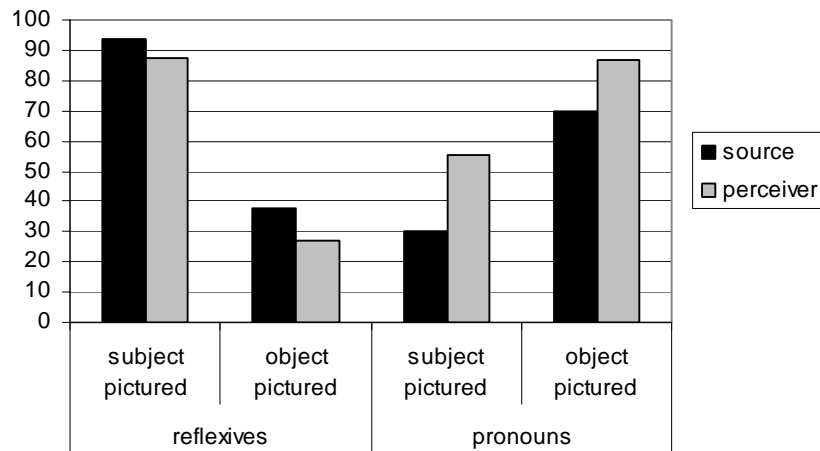

Figure 2. Results of Experiment 1, percentage of 'yes' answers

If we put together the reflexive and pronoun results, we see that the verb manipulation has an effect on both anaphoric forms,ⁱⁱⁱ with reflexives preferring sources and pronouns preferring perceivers. However, there is a difference in the strength of the effects, with pronouns being more sensitive to this kind of information than reflexives.^{iv} These results are consistent with the results of psycholinguistic eye-tracking research (Runner, Sussman & Tanenhaus 2003) testing a simple discourse manipulation which had a much greater effect on pronouns than on reflexives.

3. Experiment 2: Picture-choosing Task

This experiment addresses a question left open by Experiment 1, namely: do the effects of verb type persist in a context where people need to choose between a BT-compatible and a BT-incompatible interpretation? In other words, if we explicitly pit BT and discourse/semantic factors against each other, which is a more powerful influence on antecedent choice? To investigate this question, we used the same kinds of auditorily-presented sentences as Experiment 1, but instead of being shown a scene consisting of the two mentioned characters and a

picture of one of the characters, participants saw (on a sheet of paper) a scene with two characters and a picture of each character (Fig 3) and had to select one of the pictures (simply by circling it). Since the visual scene always included a BT-compatible picture choice, participants were always forced to choose between a BT-compatible choice and a non-BT compatible choice. We crossed verb type (*told/heard*) and anaphoric form (*himself/him*) to create four conditions. There were 20 critical items, and half contained two male referents and half contained two female referents. Twenty-four native English speakers from the University of Rochester community participated in this experiment.

(9) Peter {told/heard from} Andrew about the picture of {him/himself} on the wall.

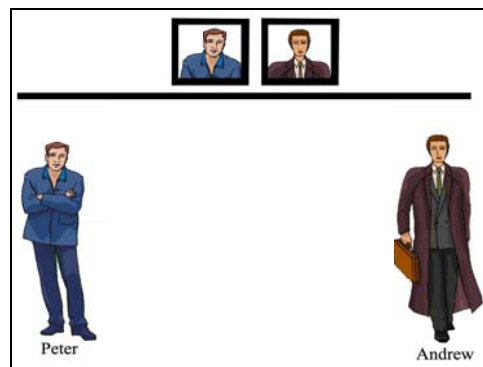

Figure 3. Sample scene for Experiment 2

3.1 Predictions

As for Experiment 1, we predict that if source-of-information influences whether a given entity can act as the antecedent for a logophoric reflexive, we should see more non-subject/logophoric responses with *heard* than with *told*. If ‘perceiving subjects’ are good antecedents for short-distance pronouns, we predict that there will be more subject responses with *heard* than with *told*.

3.2 Results

As Figure 4 shows, for reflexives we again see an overall preference to interpret the reflexive as referring to the subject. Although there is a slight numerical effect of the verb manipulation in the direction predicted by Kuno’s claims, it is not significant. For pronouns, there is a strong effect of the verb manipulation in the predicted direction. In other words, there are more subject choices in the *heard* condition than in the *told* condition, i.e. pronouns have a perceiver preference. People are more likely to interpret the pronoun in the picture NP as a

BT-exempt pronoun^v referring to the subject when the subject is the perceiver than when the subject is not the perceiver.

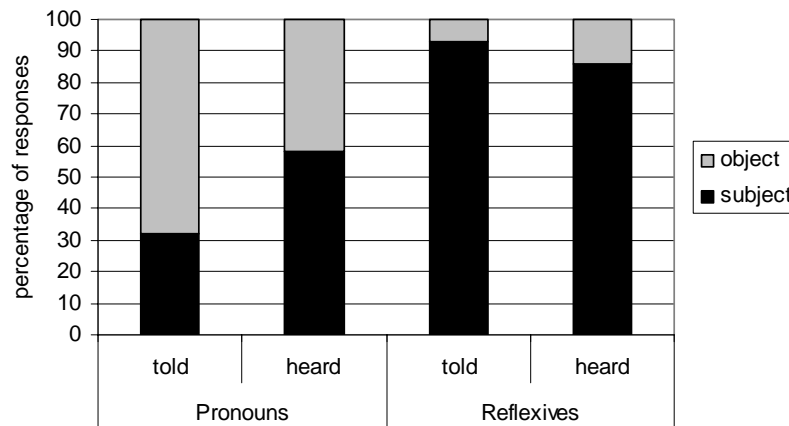

Figure 4. Results of Experiment 2, percentage of subject and object choices

As a whole, Experiment 2 shows that when we force participants to choose between a BT-compatible and BT-incompatible interpretation, we still see strong effects of verb type for pronouns but weaker effects for reflexives (though numerically still in the predicted direction). The differences between the reflexive results of Experiments 1 and 2 suggest that a forced-choice task may mask, to some degree, the effects of the source/perceiver manipulation. This suggests that a picture verification task with one-picture scenes (Experiment 1) allows participants to consider interpretations they might not immediately pursue in a forced-choice task with a two-picture scene (Experiment 2), and thus the one-picture verification task is a more sensitive diagnostic for the interpretations available to an anaphor.

4. Experiment 3: Eye-tracking

To gain a better understanding of the incremental, real-time processing of pronouns and reflexives in picture NPs, we conducted an eye-tracking experiment. Experiments 1 and 2 showed that pronouns prefer perceivers and reflexives prefer sources, but that the effects are stronger for pronouns. In order to find out how the source/perceiver effects are reflected in real-time processing, we investigated the time-course of interpretation. We used a light-weight head-mounted eye-tracker (ISCAN EC-501) to record participants' eye movements in real time as they saw scenes displayed on a computer monitor and listened to

sentences similar to those in Experiments 1 and 2. The participants' task was to click (using the computer mouse) on the picture mentioned in the sentence. With this design, we obtain both off-line picture selection data as well as incremental eye movement data. Previous research has shown that eye movements to objects/pictures are closely time-locked to the potential referents that a listener considers as language unfolds over time (Cooper et al. 1974, Tanenhaus et al. 1995, Arnold et al. 2000), and thus participants' eye movements should closely reflect the time course of their anaphor resolution process.

There were 36 critical items and 54 fillers, half with two male referents and half with two female referents. Sixteen native English speakers from the University of Rochester community participated in this experiment. Similar to Experiment 2, we crossed verb type and anaphoric form (*himself/him*) to create four conditions. In the eye-tracking experiment, in addition to *told* and *heard*, we also used two other *told*-type verbs (*informed*, *notified*) and two other *heard*-type verbs (*learned from*, *found out from*). However, to make the eye-tracking results comparable to the findings from the first two experiments, in this paper we only discuss the results for *told* and *heard*.

4.1 Results

Let us start by considering the off-line picture choice responses. As Figure 5 shows, the results closely resemble the data from Experiment 2. With reflexives, there is an overall preference for the subject of the sentence, with a weak numerical effect in the predicted direction. In the pronoun conditions, we see a perceiver preference. There are more subject-interpretations with *heard* than *told*, as predicted.^{vi}

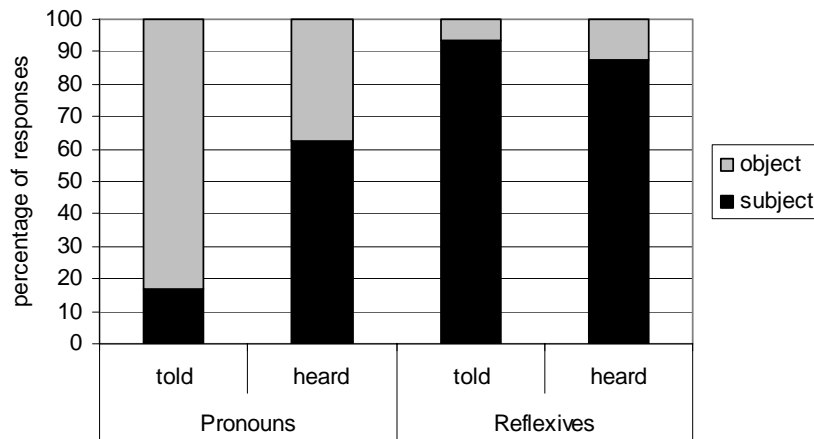

Figure 5. Off-line results for Experiment 3, percentage of subject and object choices

The eye movement data from 200ms to 600ms after the onset of the anaphor are shown in Figure 6. Given the time it takes to program an eye movement, the start of this time window is the earliest point at which one would expect to see signal-driven eye movements (Matin, Shao & Boff 1993). The graph shows the 'subject picture advantage', which was calculated by taking the proportion of time that participants spent looking at the picture of the subject in a given time slice and subtracting off the proportion of time spent looking at the picture of the object during that same time slice. Thus, a positive 'subject picture advantage' means that participants spent more time looking at the subject's picture than the object's picture. A negative 'subject picture advantage' means they spent more time looking at the object's picture than the subject's picture.

The data show that, with pronouns, participants look more at the object picture when the object is the perceiver of information (with *tell*) than when the object is the source (with *hear from*). For reflexives, the eye movement data also reveal a verb effect; the fine-grained information provided by participants' eye movements shows that reflexives are sensitive to source-of-information. Starting 200ms after the onset of the reflexive, there is a reliable difference in the proportion of looks to the picture of the object when the object is the source and when it is the perceiver of information. In other words, participants spend more time considering BT-incompatible interpretations with sources than perceivers.

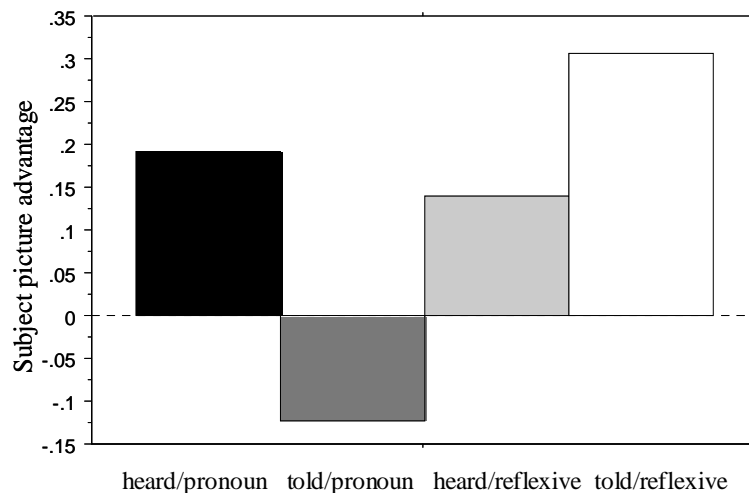

Figure 6. Subject picture advantage for the time window from 200ms to 600ms after the onset of the anaphor

5. Discussion, Conclusions

Taken as a whole, the off-line data presented in this paper show that pronouns are strongly influenced by verb type. Short-distance pronouns occur more often when the antecedent is the perceiver of information. For reflexives, Experiment 2 shows that source-of-information antecedents do trigger somewhat more logophoric readings than non-source antecedents, but reflexives are not as sensitive to the verb manipulation as pronouns. The eye movement data for pronouns support the perceiver preference observed in the off-line findings. Furthermore, the eye movement patterns for reflexives reveal that they, too, are influenced by verb type; participants look more at the picture of the object when the object is the source of information.

An important question for future work is, why is the verb effect stronger for pronouns than reflexives? Why are pronouns more influenced by a potential antecedent being the perceiver of information than reflexives are by sources of information? One possible account hinges on the fact that pronouns are also used as discourse anaphors in free/non-bound positions (e.g. *Lisa called Alice yesterday. She wanted to ask if Alice could help her with something*), where their interpretation has been found to be guided by discourse salience (e.g. Ariel 1990, Givón 1983, Gundel, Hedberg & Zacharski 1993), verb semantics (e.g. Stevenson, Crawley & Kleinman 1994) as well as other factors. In light of such uses, one could argue that it is not surprising that pronouns would turn out to be susceptible to discourse/semantic factors in picture NP contexts as well. A related approach builds on the idea that dispreferred interpretations are easier to influence than preferred interpretations. The sentences we tested are asymmetrical in that they permit reflexives to achieve their preferred interpretation (subject) but do not give pronouns the possibility of achieving their preferred interpretation, namely a referent mentioned in a preceding sentence (Runner, Sussman & Tanenhaus 2003). Thus, the idea is that reflexives exhibit a strong subject preference and are able to satisfy this preference, but pronouns are unable to achieve their preferred interpretation. Therefore, if dispreferred interpretations are easier to influence, it is not surprising that pronouns are more susceptible to verb information. In future work, we hope to investigate these questions in more depth.

Notes

* We thank Rebekka Puderbaugh for her invaluable help in running the participants for Experiment 3 and coding the eyetracking data. This research was partially supported by NSF grant BCS-010776 and NIH grant HD-27206.

ⁱ We often use the hybrid label 'discourse/semantic factors' when discussing the effects of non-structural factors on pronouns and reflexives. One could argue that the source/perceiver manipulation is a semantic, theta-role manipulation. However, it could also be argued that

source/perceiver is related to perspective-taking, which can be regarded as a discourse-related factor. The semantics/discourse distinction is an important question for future work.

ⁱⁱ Depending on what is assumed to be the syntactic position of the direct object, one could argue that the direct object of a verb like *tell*—unlike the object of a preposition, as with *hear from*—c-commands the picture NP (see Contreras 1984, *inter alia*) and the direct object is therefore a possible antecedent for a reflexive pronoun and not a possible referent for a pronoun. However, as will become clear later, this alternative account for differences between *tell* and *hear from* does not receive support from the empirical data.

ⁱⁱⁱ These results argue against the potential alternative account mentioned in footnote ii, namely that differences between *tell* and *hear from* could be a result of direct objects c-commanding picture NPs and objects of prepositions failing to do so. If a direct object c-commands the picture-NP, then *himself* should be better than *him* for referring to the object with *tell*. However, this is clearly not supported by our results. Moreover, according to the alternative account, the object of a preposition cannot c-command the picture NP, and thus *himself* should never be able to refer to it. However, contrary to this prediction, we found more object interpretations with *heard from* than with *told*. Ultimately, it is not this aspect of the structure that seems to make the difference, but rather the discourse/semantic role of the constituent.

^{iv} Further details regarding the designs and results of the experiments discussed in this paper are available from the first author and will be presented in an article in preparation.

^v Note that Tenny (2003) proposes point-of-view/sentence-based binding domains and argues that pronouns must be free in their local point-of-view domains. Our use of the term ‘BT-exempt’ in this paper refers to being exempt from the requirements of standard BT (as outlined in (2)), which predicts examples like those in (7) to be ungrammatical.

^{vi} Interestingly, the two new verbs introduced in this experiment, *informed* and *notified*—which are factive—prompt a surprisingly high proportion of non-BT compatible object interpretations for reflexives. Observing a connection between factivity and non-BT compatible reflexives is not new: Factivity has been noted as being relevant for long-distance reflexives in Icelandic and Norwegian (Thráinsson 1976, Strahan 2001). See Kaiser, Runner, Sussmann & Tanenhaus (in prep) for more detailed discussion regarding the connection between factivity, the notion of source-of-information and *de se*/awareness interpretations.

References

- Ariel, Mira. 1990. *Accessing NP antecedents*. London: Routledge, Croom Helm.
- Arnold, Jennifer E., Janet G. Eisenband, Sarah Brown-Schmidt & John C. Trueswell. 2000. “The rapid use of gender information: evidence of the time course of pronoun resolution from eye-tracking”, *Cognition*, **76**:B13-B26.
- Cantrall, William R. (1974) *Viewpoint, Reflexives, and the Nature of Noun Phrases*. The Hague: Mouton.
- Chomsky, Noam. 1981. *Lectures on Government and Binding*. Dordrecht: Foris.
- Chomsky, Noam. 1986. *Barriers*. Cambridge, Mass.: MIT Press.
- Clements, G. N. 1975. “The logophoric pronoun in Ewe: its role in discourse”, *Journal of West African Languages*, **10.2**:141-177.
- Contreras, Heles. 1984. “A Note on Parasitic Gaps”, *Linguistic Inquiry*, **15**:698-701.
- Cooper, R.M. 1974. “The control of eye fixation by the meaning of spoken language: a new methodology for the real-time investigation of speech perception, memory and language processing”, *Cognitive Psychology*, **6**:84-107.

- Givón, Talmy. 1983. *Topic continuity in discourse: A quantitative cross-language study*. Amsterdam: John Benjamins.
- Gundel, Jeanette K., Nancy Hedberg & Ron Zacharski. 1993. "Cognitive status and the form of referring expressions in discourse", *Language*, **69**:274-307.
- Hagège, C. 1974. "Les pronoms logophoriques", *Bulletin de la Societe de Linguistique de Paris* **69**:287-310.
- Keller, Frank & Ash Asudeh. 2001. "Constraints on linguistic coreference: Structural vs. pragmatic factors", in Johanna Moore & Keith Stenning, eds., *Proceedings of 23rd Annual Conference of the Cognitive Science Society*, 483-488. Mahwah: L. Erlbaum.
- Kuno, Susumu. 1987. *Functional Syntax: Anaphora, discourse & empathy*. Chicago: University of Chicago Press.
- Matin, Ethel, Shao, K.C. & Boff, K.R. 1993. "Saccadic overhead: information processing time with and without saccades", *Perception & Psychophysics*, **53**.4:372-380.
- Pollard, Carl & Sag, Ivan. 1992. "Anaphors in English and the scope of Binding Theory", *Linguistic Inquiry*, **23**:261-303.
- Reinhart, Tania & Eric Reuland. 1993. "Reflexivity", *Linguistic Inquiry*, **24**:657-720.
- Runner, Jeffrey T., Rachel S. Sussman & Michael K. Tanenhaus. to appear. "The Influence of Binding Theory on the On-Line Reference Resolution of Pronouns," in *Proceedings of North Eastern Linguistic Society* 34.
- Runner, Jeffrey T., Rachel S. Sussman & Michael K. Tanenhaus. 2003. "Assignment of reference to reflexives and pronouns in picture noun phrases: evidence from eye movements", *Cognition*, **89**.1:B1-B13.
- Runner, Jeffrey T., Rachel S. Sussman & Michael K. Tanenhaus. 2002. Logophors in Possessed Picture Noun Phrases. In Line Mikkelsen and Chris Potts, eds., *WCCFL 21 Proceedings*, 401-414. Somerville, MA: Cascadilla Press.
- Sells, Peter. 1987. "Aspects of Logophoricity", *Linguistic Inquiry*, **18**.3:445-479.
- Stevenson, Rosemary J., Rosalind A. Crawley, & David Kleinman. 1994. "Thematic roles, focus, and the representation of events", *Language and Cognitive Processes*, **9**:519-548.
- Strahan, Tania. 2001. *Long-distance reflexives in Norwegian*. Ph.D. dissertation, University of Melbourne, Australia.
- Tanenhaus, Michael K., Michael J. Spivey-Knowlton, Kathleen M. Eberhard & Julie E. Sedivy. 1995. "Integration of visual and linguistic information in spoken language comprehension", *Science*, **268**:632-634.
- Tenny, Carol. 1996. *Short distance pronouns and locational deixis*. LinguistList on-line conference.
- Tenny, Carol. 2003. *Short distance pronouns, argument structure, and the grammar of sentience*. Ms.
- Tenny, Carol. 2004. *Short Distance Pronouns in Representational NPs and a Grammar of Sentience*. Ms.
- Thráinsson, Höskuldur. 1976. "Reflexives and subjunctives in Icelandic." In A. Ford, J. Reighard, R. Singh, eds., *Papers from the Sixth Meeting of the North Eastern Linguistics Society*, Montreal Working Papers in Linguistics, 225-239, McGill University, Université de Montréal and Université de Québec á Montreal.
- Zribi-Hertz, Anne. 1989. "Anaphor Binding and Narrative Point of View English Reflexive Pronouns in Sentence and Discourse", *Language*, **65**.4: 695-727.

The Syntactic Visibility of Intentionality: Evidence from Dyadic Unaccusatives

Dalina Kallulli
University of Vienna

1. Unaccusatives with Overt Causers and Experiencers¹

In several Balkan languages a passive core may combine with a dative DP, yielding among other possible interpretations an involuntary state reading, rendered through ‘feel like’ in English, as for the Albanian sentence in (1).² (‘Nact’ in the glosses stands for non-active voice.³)

- (1) a. Benit i ndërto-hej (një shtëpi).
Ben.the_{dat} him_{dat.cl} build-Nact,P,Imp3S a house_{nom}
‘Ben felt like building (a house)’

On the other hand, according to Rivero (2004) all Balkan languages share the construction in (2), in which a dative/genitive combines with an anticausative core, yielding among other possible interpretations (discussed most recently in Kallulli 2006a,b) a reading best described in terms of unintended causation. This reading obtains also in other languages, e.g. German and Spanish, as in (2b,c).

- (2) a. Albanian: Benit i-u thye dritarja.
Ben.the_{dat} him_{dat.cl}-nact.Aor broke.3S window.the_{nom}
‘Ben unintentionally broke the window’
b. German: Dem Ben ist das Fenster zerbrochen.
the_{dat} Ben is the_{nom} window broken
‘Ben unintentionally broke the window’
c. Spanish: A Pedro se le rompió el coche.
To Pedro REFL cl.dat broke the car
‘Pedro unintentionally broke the car’

In spite of the interpretive differences between the sentences in (1) on the one hand and those in (2) on the other, the dyadic predicates in (1) and (2) qualify as unaccusative by several criteria, as discussed in Kallulli (2006a,b). The

sentences in (1), (2) may then be described as dative unaccusative constructions (DUCs).

While the unintended causation reading is missing in (1), both the involuntary state reading and the unintended causation reading may obtain with one and the same predicate, as illustrated through the Albanian examples (3a) vs. (3b), which differ in terms of their grammatical aspect only. As revealed in the glosses in (3a,b), Albanian has two forms for simple past tense (P) that differ in their aspectual value: aorist (Aor), which is perfective, and imperfective (Imp). Only the perfective sentence in (3a) but not the imperfective in (3b) can get an unintended causation reading. On the other hand, with imperfective aspect only the involuntary state reading but not the unintended causation reading obtains.

- (3) a. Benit i-u thye dritarja.
 Ben.the_{dat} him_{dat.cl}-nact.Aor break.3S window.the_{nom}
 (i) ‘Ben unintentionally broke the window’
 (ii) *‘Ben felt like breaking the window’
- b. Benit i thy-hej dritarja.
 Ben.the_{dat} him_{dat.cl} break-Nact,P,Imp3S window.the_{nom}
 (i) ‘Ben felt like breaking the window’
 (ii) *‘Ben unintentionally broke the window’

The semantic complementarity observed in (3) does not obtain with a non-external causation verb. The sentences in (4a) and (4b) differ morphologically exactly in the same way in which (3a) and (3b) differ. However, the unintended causation reading of (3a) does not obtain in (4b).

- (4) a. Benit i ndërto-hej (një shtëpi).
 Ben.the_{dat} him_{dat.cl} build-Nact,P,Imp3S a house_{nom}
 (i) ‘Ben felt like building (a house)’
 (ii) *‘Ben unintentionally built (a house)’
- b. Benit i-u ndërtua (një shtëpi).
 Ben.the_{dat} him_{dat.cl}-nact.Aor build-3S a house_{nom}
 (i) ‘Ben felt like building (a house)’
 (ii) *‘Ben unintentionally built (a house)’

Why doesn’t the pattern in (3) replicate in (4)? The explanation must be that non-active morphology interacts differently with different (feature) primitives. That is, the lexical (and consequently syntactic) feature composition make-up of (the root of) *eat* is different from that of *break*. For the purposes of this article, abstracting away from state-denoting verbs, I will simply assume that activity verbal roots (e.g. *build*) differ from causative roots (e.g. *break*) lexically (and syntactically) in that the former project an [+act] feature and the latter a [+cause] feature in *v*. That is, I will assume that [+act] and [+cause] are primitives.

The main goal of this paper is to uniformly derive the involuntary state and the unintended causation reading of the DUC, as well as monadic unaccusatives (i.e. passives, anticausatives, middles, reflexives), which share the same morphology.

2. Predicate Structure

2.1 The structure of causative predications

Davis and Demirdache (1995) and Demirdache (1997) argue that agentive and causative predications are universally derived from distinct frames. The basic idea here is that an event participant identifying the instigation of a causative event is an agent if and only if that participant *intentionally* brings about such an event. To illustrate, paraphrasing Demirdache (1997), *Rosa* in (5) is an agent iff Rosa performs some action of melting which causes the ice to be melted. In contrast, *Rosa* is a causer (but not an agent) when there is no intentionality involved – e.g. Rosa accidentally turns off the fridge and the ice melts.

(5) Rosa melted the ice.

In this spirit, I contend that the two types of causative predications (agentive and non-agentive) differ in their feature composition make-up. While agentive causatives can be defined as an **ordered tuple** consisting of the features [+intent] (for *intentionality* or agency) and [+cause] in little *v*, as depicted in (6), non-agentive causatives lack the feature [+intent], as shown in (7). Accordingly, the tuple <[+intent],[+cause]> in *v* makes an agent in Spec of *v*P, as shown in (6). In contrast, the tuple <[+cause]> makes a causer, but not an agent, as in (7).

(6) The structure of agentive causatives

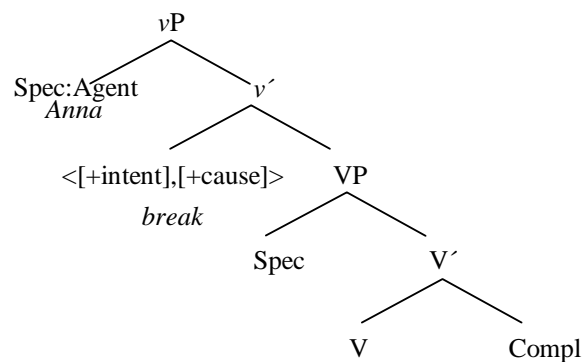

(7) The structure of non-agentive causatives

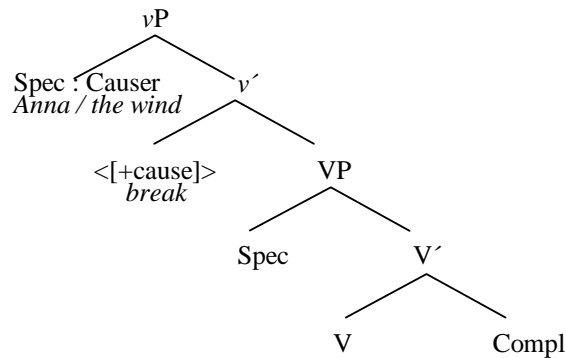
**2.2 The structure of activity (or process) predications**

I claim that, like causatives, activity predications fall into two different types: agentive and non-agentive. Agentive activities differ from non-agentive activities in terms of their feature composition: agentive activity predicates are ordered tuples consisting of the features $[+intent]$ and $[+act]$ in little v , as in (8), whereas non-agentive activities are ordered tuples consisting of the feature $[+act]$ only, as in (9). The tuple $\langle [+intent],[+act] \rangle$ makes an agent in Spec of vP , as in (8). In contrast, the tuple $\langle [+act] \rangle$ makes an actor, not an agent, as in (9).

(8) The structure of agentive activities

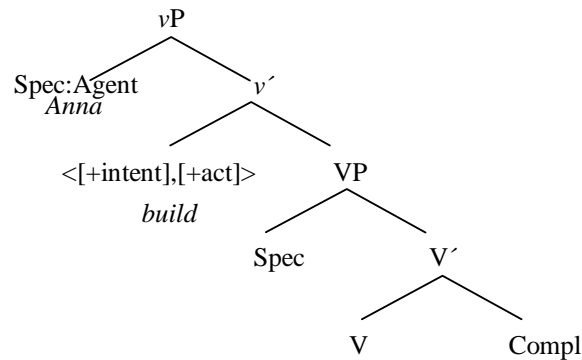

(9) The structure of non-agentive activities

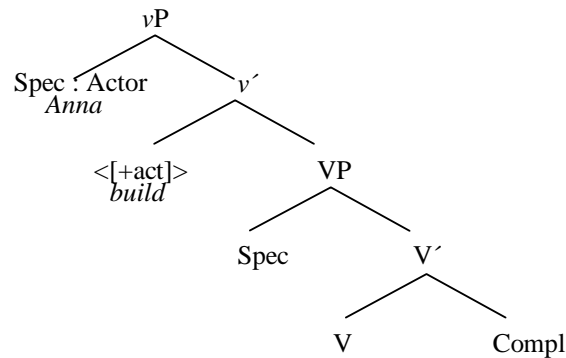

In other words, I contend that a sentence containing an activity predicate as in (10) is ambiguous between an agentive and a non-agentive reading.

(10) Rosa screamed.

Rosa in (10) is an agent iff she intends her action, i.e. she could stop screaming if she so willed. In contrast, *Rosa* in (10) is an actor but not an agent if she does not intend her screaming activity (e.g. she is on drugs that make her scream and possibly even unaware of her screaming).

3 Analysis

3.1 Defining non-active morphology

Much research has maintained that certain morphological operations apply either in the lexicon, or in the syntax. To wit, passivization, and/or reflexivization have commonly been treated as operations that suppress either an argument position (external or internal), a theta role in the thematic grid of the verb, or some element in the lexical-semantic structure of a predicate (depending on the theory) (cf. Grimshaw 1990, Levin and Rappaport Hovav 1995, Rappaport Hovav and Levin (1998), among others). In this spirit, also here I will analyse non-active morphology as a suppression operation. However, unlike the types of suppression just cited, I believe that non-active morphology operates in the syntax solely and purely in a linear fashion fully ignoring the content of the element that it affects. Specifically, I define non-active morphology as in (11).

(11) *Definition of non-active/reflexive (and other unaccusative) morphology*

Non-active (and other unaccusative) morphology suppresses the first feature in a predicate structure.

3.2 Deriving the unintended causation reading

I contend that the unintended causation reading of the dative unaccusative constructions in (2) is derived from (dyadic) agentive causative predications, the structure of which was given in (6). Specifically, if the definition in (11) is applied to the structure in (6), the outcome is the representation in (12), since the first feature in (6) is [+intent].

(12)

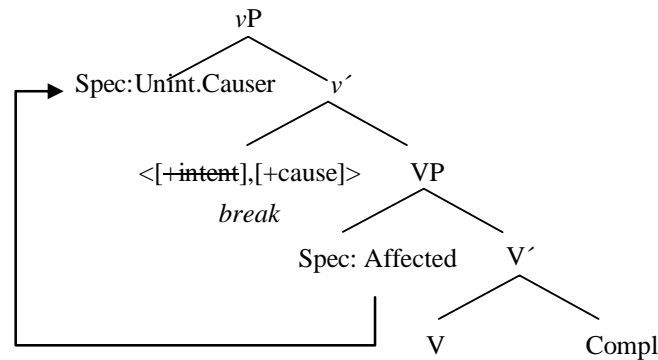

Due to the suppression of [+intent], no agent will be projected in Spec of vP. The feature [+cause] on the other hand is too little to assign a theta-role since the integrity of the tuple has been affected due to suppression of a feature, the idea being that assignments are tuples. On the other hand, for the derivation to converge the feature [+cause] has to be saturated. The only way for this feature to be licensed is by another argument moving to the specifier of vP. I claim that the dative argument projected in the Spec of VP is the one that fulfils this role. Let us assume that the feature that licenses the projection of the dative argument in Spec, VP is [+affected], which is why the dative here will be interpreted as an affected participant. When non-active morphology suppresses the feature [+intent], the dative argument moves from Spec of VP to Spec of vP so that the [+cause] feature is licensed. Consequently, once in Spec of vP, the theta-role of the dative will be something like an affected causer, which I argue is identical to unintentional causer. Precisely because of this syntactic (and semantic) composition, the dative argument in an unaccusative construction will always be ambiguous between an affected and a causer interpretation, unless pragmatic considerations (dis)favour one of these readings.

3.3 Deriving the involuntary state reading (ISR)

3.3.1 The simple(r) case: 'build'-type verbs and the ISR

Paralleling the discussion on the derivation of the unintended causation reading from dyadic agentive causatives, I claim that the involuntary state reading of the sentence in (1) is derived from (dyadic) agentive activity predications. The structure of dyadic agentive activities was given in (8). If the definition in (11) is applied to this structure, the outcome is the representation in (13), since the first feature in the structure in (8) is [+intent].

(13)

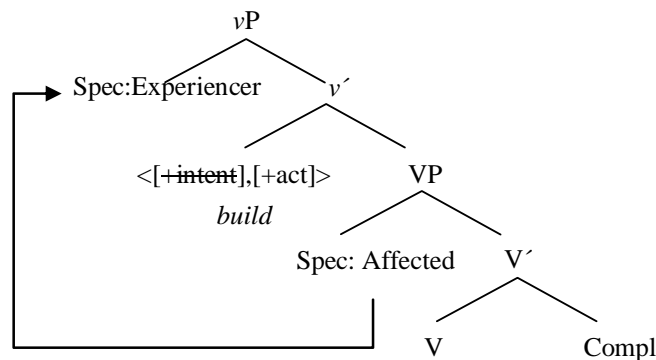

Again, the suppression of [+intent] here eliminates the possibility of the projection of an agent argument in Spec of vP. On the other hand, the remaining feature [+act] in v is not enough to make an actor since theta-role assignments are tuples. However, the derivation can be saved if the remaining feature in v, namely [+act] can be saturated in another way. As in the previous case, the only way for this feature to be checked off is by another argument moving to the Specifier of vP. Again, I claim that the dative argument introduced in the Spec of VP by the feature [+affected] of the root under V moves to Spec of vP to license the [+act] feature. Due to the bundling of the features [+affected] and [+act] upon movement of the dative argument to Spec of vP its resulting theta role will be something like an *affected actor*, which, metaphysically speaking, comes rather close to *experiencer*, which is how the dative argument is interpreted in the sentence in (1).

3.3.2 The hard(er) case: 'break'-type verbs and the ISR

While this analysis accounts for data like (1), the question arises whether and how the semantic complementarity in terms of the unintended causation vs. involuntary state reading between (3a) and (3b) can be captured by this analysis.

Both (3a) and (3b) contain the same verbal root. As discussed earlier, formally (3a) and (3b) differ only with regard to aspectual morphology. While the unintended causation reading of (3a) is straightforwardly derived under the analysis in 3.2, this cannot explain how the involuntary state reading of (3b) comes about. On the other hand, recall that as a causative root, the ontological event type of *break* is not [+act] but [+cause]. As such, it is expected to project a [+cause], not a [+act] feature in the syntax. However, if it does not project a [+act] feature the analysis in the previous section cannot readily account for the involuntary state reading of (3b).

I suggest that though the root *break* is causative rather than process-like, i.e. it is expected to project the feature [+cause] and not [+act], due to a procedure such as event composition (Pustejovsky 1991), it projects a [+act] (not a [+cause]) feature in the syntax. Specifically, I assume that imperfective morphology is an event functor that invariably shifts the event type of a root into a process. That is, when imperfective morphology quantifies over telic event types it yields atelic events, which will be projected as such in syntax.

3.4 Deriving the anticausative, passive and middle

I argue that the anticausative, passive and middle formations are derived from non-agentive predications, the structure of which was given in (7) and (9) for causative and activity verbs, respectively. Non-active/reflexive morphology was in (11) defined as an operation that suppresses the first feature in a predicate structure. Note that the first feature in the structures in (7) and (9) is [+cause] and [+act], respectively, so when this feature is suppressed by non-active/reflexive morphology, the outcome of this operation will be basically a monadic unaccusative structure, as in (14) and (15).

(14)

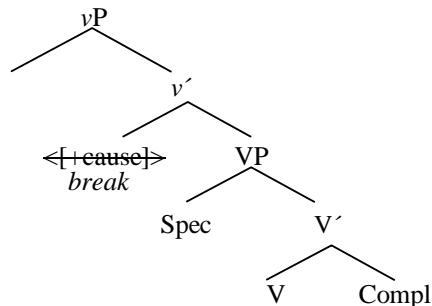

(15)

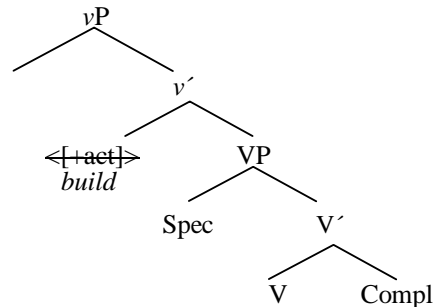

Anticausatives are derived when non-active/reflexive morphology operates on the structure of an aspectually telic non-agentive causative (recall the semantic complementarity between the perfective (3a) and the imperfective (3b)).

The distinction between a passive and a middle is, I believe, due to the difference between different aspectual operators. Specifically, the middle construction is derived when the verb in the structures in (14) and (15) is under the scope of a dispositional operator, such as the imperfective (though the notion ‘imperfective’ does not seem to be semantically homogenous). In contrast, passive obtains when the verb in (14) and (15) is under the scope of a non-dispositional aspectual operator (such as generic-habitual or episodic).

Space limitations prevent me from discussing the irrelevance of arguments bearing on facts such as the sanctioning of *by*-phrases or control into purpose clauses and/or adverbs of intentionality in passives vs. their impossibility in anticausatives and middles in English for the analysis that I have outlined here. However, I have discussed these issues in detail elsewhere, so the interested reader is referred to Kallulli (to appear).

3.5 Deriving reflexives

I claim that reflexives are derived from transitive agentive activities (i.e. basically the structure in (8)) when Spec, VP is empty (alternatively, not there). That is, as different from the dative unaccusative construction, reflexives are *not* derived from di-transitive agentive activities. By the definition in (11), when non-active morphology operates on a transitive agentive activity shell it suppresses the feature [+intent] in the tuple in *v* since this is the first feature. Since the only way for the remaining feature in the tuple, namely [+act] to get saturated is by another argument moving to its specifier position (recall the discussion in section 3.3), the internal argument (i.e. the theme) will move to Spec of *vP*, becoming therefore an actor theme, which is exactly how the surface subject of reflexives is interpreted.

(16)

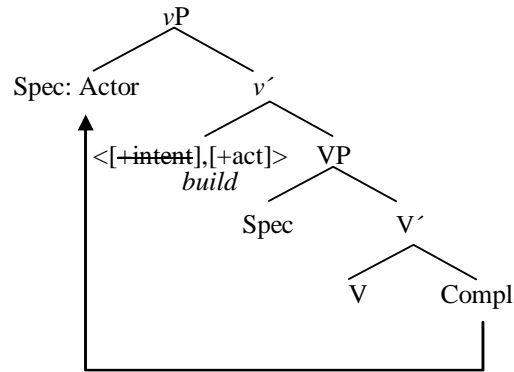

4 Conclusion and open questions

A range of unaccusative constructions across languages (to wit the dative unaccusative construction and its various interpretations, as well as anticausatives, passives, middles and reflexives) can be formally and uniformly derived by combining the idea that agentive (both causative or activity) predications and non-agentive (both causative or activity) predications are universally derived from distinct frames (i.e. feature tuples) and that unaccusative morphology is a feature-suppression operation in the syntax that invokes linearity, a well-supported principle of cognitive processing.

Several other conclusions can be drawn. For instance, sentences such as in (1) show that telicity is not a semantic determinant of argument expression (in the sense that it does not determine grammatical function, which following Marantz (1984) and Levin (2000), I take to be the core of argument expression). Also, the data presented here support the claim in Rappaport Hovav and Levin (2002) that although argument expression is not determined entirely on the basis of its lexical feature composition make-up, a verb's (alternatively, a verbal root's) lexicalized meaning is important to determining or constraining its argument expression options, a view also maintained in Hale and Keyser (1993, 1998).

Another important conclusion is that theta roles are not primitives in the theory, but derived from the featural content of syntactic heads. In this respect, the analysis here is reminiscent of Reinhart's (2002), though there are several important differences, which due to space considerations, cannot be addressed here, but see Kallulli (2006a,b).

The analysis that I have proposed makes several clear predictions. First, it predicts that non-agentive verbs of internal causation (e.g. *blush*, *tremble*, etc.) cannot appear in the dative unaccusative construction. Second, the analysis outlined here predicts that verbs of emission cannot appear in the dative unaccusative construction, either. Third, it predicts that extrinsic instigators

cannot appear in the dative unaccusative construction. All three predictions hold across all the languages cited.

I have glossed over some aspects which need to be dealt with in the framework of an integrated theory of the syntactic projection of unaccusatives. First, I haven't gone into issues concerning the inability of accusative case assignment, but this specific aspect can in general be dealt with along the lines of Bennis (2004). Another open question is why the involuntary state reading which obtains in the rest of the Balkan languages does *not* obtain in Greek and Rumanian, which further scrutiny notwithstanding, seem to have the formal ingredients necessary for the licensing of this interpretation.

Notes

¹ I would like to thank Hubert Haider and Edwin Williams for invaluable feedback. Research for this paper was funded by the Austrian Science Fund, grant T173-G03.

² In Kallulli (2006a,b) I have argued contra Rivero (2004) that constructions such as (1) (and (2)) are truly ambiguous, not vague. Space limitations prevent me from presenting these arguments here.

³ Active vs. non-active voice correspond roughly to the distinction unergative/unaccusative. This correspondance is rough by virtue of the fact that while unergatives are always active morphologically, some unaccusative verbs appear in this voice (i.e. are morphologically unmarked), too. For details, see Kallulli (1999, 2006b) on Albanian, Alexiadou and Anagnostopoulou (2004) on Greek. Crucially, however, unergatives cannot be formally non-active, just as passives, lexical reflexives and middles cannot be formally active.

References

- Alexiadou, Artemis, Elena Anagnostopoulou and Martin Everaert. 2004. *The Unaccusativity Puzzle*. Oxford: Oxford University Press.
- Alexiadou, Artemis and Elena Anagnostopoulou. 2004. Voice morphology in the causative-inchoative alternation: evidence for a non-unified structural analysis of unaccusatives. In A. Alexiadou et al. (eds.) *The Unaccusativity Puzzle* 114-136. Oxford: Oxford University Press.
- Bennis, Hans. 2004. Unergative adjectives and psych verbs. In A. Alexiadou et al. (eds) *The Unaccusativity Puzzle* 84-113. Oxford: Oxford University Press.
- Davis, Henry and Hamida Demirdache 1995. *Agents and Events*. Paper presented at the GLOW Colloquium, University of Tromsø, Norway.
- Demirdache, Hamida. 1997. Out of control in St'at'imcets Salish and event (de)composition. *Theoretical Issues on the Morphology Syntax Interface: Supplements of the International Journal of Basque Linguistics and Philology*.
- Grimshaw, Jane. 1990. *Argument Structure*. Cambridge, MA: MIT Press.
- Hale, Ken and Jay Keyser. 1998. The basic elements of argument structure. *MIT Working Papers in Linguistics* 32: 73-118.
- Kallulli, Dalina. 1999. Non-active morphology in Albanian and event (de)composition. In Istvan Kenesei (ed.) *Crossing Boundaries* 263-292. Amsterdam: John Benjamins.
- Kallulli, Dalina. 2006a. Unaccusatives with overt causers and experiencers: a unified account. In D. Hole, A. Meinunger and W. Abraham (eds.) *Datives and Other Cases*:

- Between argument structure and event structure* 271-301. Amsterdam: John Benjamins.
- Kallulli, Dalina. 2006b. Unaccusative morphology in syntax. Manuscript, University of Vienna.
- Kallulli, Dalina. To appear. Argument demotion as feature-suppression. In B. Lyngfeldt and T. Solstad (eds.) *Demoting the Agent: Passive and other Voice-related Phenomena*. Amsterdam: John Benjamins.
- Levin, Beth and Malka Rappaport Hovav. 1995. *Unaccusativity*. Cambridge, MA: MIT Press.
- Levin, Beth. 2000. Aspect, lexical semantic representation, and argument expression. *Berkley Linguistic Society*.
- Marantz, Alec. 1984. *On the Nature of Grammatical Relations*. Cambridge, MA.: MIT Press.
- Pustejovsky, James. 1991. The syntax of event structure. *Cognition*, **41**: 47-81.
- Rappaport Hovav, Malka and Beth Levin. 1998. Morphology and lexical semantics. In Arnold Zwicky and Andrew Spencer (eds.) *Handbook of Morphology* 248-71. Oxford: Blackwell.
- Rappaport Hovav, Malka and Beth Levin. 2002. Change of State Verbs: Implications for Theories of Argument Projection. In *Proceedings of BLS 28*.
- Reinhart, T. 2002. The Theta System: an Overview. *Theoretical Linguistics*, **28**, 3: 229-290.
- Rivero, Maria-Luisa. 2004. Datives and the non-active voice: Reflexive clitics in Balkan languages. In O. Tomic (ed.) *Balkan Syntax and Semantics* 237-267. Amsterdam: John Benjamins.

Dalina Kallulli
 Department of Linguistics
 University of Vienna
 Berggasse 11
 A-1090 Vienna, Austria
 dalina.kallulli@univie.ac.at

Phonological Systems in Bilinguals: Age of Learning Effects on the Stop Consonant Systems of Korean-English Bilinguals

Kyung-Ho Kang & Susan G. Guion

University of Oregon

1. Introduction

The general consensus in second language (L2) acquisition research is that the earlier the age at which one learns an L2, the more likely it is that one will produce and perceive the L2 in a nativelike way. With regard to bilinguals who have been exposed to two languages, this effect of age of L2 learning could be stated such that “early” bilinguals who were first exposed to their L2 in early childhood are more likely to be “successful” learners than “late” bilinguals who were first exposed to the L2 in adolescent or adulthood. In addition to the factor of age of learning, learning process may be affected by the nature of the interaction between the L1 and the L2 of bilinguals. The current study is a phonetic investigation of the interaction of two phonological systems in Korean-English bilinguals as a function of age of L2 learning.

The age of learning effect in L2 acquisition has been investigated at various phonological levels. At one level, degree of foreign accent in L2 speech production has been investigated. The general consensus is that degree of foreign accent is determined by the age at which a learner first arrived in a L2-speaking country (e.g., Piske *et al.*, 2001). At another level, segment-based studies of L2 production have also shown age of learning effects (e.g., for consonants, Flege, 1991; Mackay *et al.*, 2001, and for vowels, Munro *et al.*, 1996; Harada, 2003). The proposal that the L2 learning process may be influenced by the nature of interaction between the L1 and L2 of bilinguals, as well as the age of L2 learning, has also been considered by several studies (e.g., Khattab, 2002; Flege *et al.*, 2003; Guion, 2003; Kehoe *et al.*, 2004; Sundara *et al.*).

2. The Stop Consonants of Korean and English

The consonant system of the Korean language contrasts three types of stops: aspirated, lenis, and fortis. These are phonetically all voiceless except for lenis stops in intervocalic position. Aspirated stops are generally described as strongly aspirated, lenis stops as lax, breathy and slightly aspirated, and fortis stops as tense, laryngealized and unaspirated. Also, these stops occur at three places of articulation: bilabial, alveolar, and velar. In contrast, English stop consonants contrast in two categories: voiceless and voiced stops. Along with this general description, acoustic characteristics of these stops have been well documented in numerous studies¹ (e.g., Lisker & Abramson, 1964; Kagaya, 1974; Klatt, 1975; Kim, 1994; Shimizu, 1996; Ahn, 1999; Cho *et al*, 2002; Kim, *et al*, 2002). Table 1 below shows acoustic-phonetic description of Korean and English stop consonants.

Table 1. Acoustic properties of Korean and English stop consonants

	VOT	H1-H2	f_0
EngVls	long-lag	more breathy voice	higher
EngVd	short-lag	more creaky voice	lower
KorAsp	long-lag	more breathy voice	higher
KorLen	long-lag	more breathy voice	lower
KorFor	short-lag	more creaky voice	higher

(The description for H1-H2 and f_0 is based on within-language comparisons. EngVls: English voiceless stops, EngVd: English voiced stops, KorAsp: Korean aspirated stops, KorLen: Korean lenis stops, KorFor: Korean fortis stops)

3. Cross-Linguistic Mapping Relations between Korean and English Stops

With regard to the issue of the nature of the phonological systems in bilinguals, as considered in cross-language mapping studies (e.g., Schmidt, 1996; Guion *et al*, 2000), conceiving the specific patterns of interaction between the L1 and L2 phonological systems will require discussion of perceived similarity/dissimilarity relationships between sounds in L1 and L2. Among the theoretical models that addressed the role of perceptual similarities/dissimilarities between L1 and L2 sounds is included the Speech Learning Model (SLM) proposed by Flege (1995). According to SLM, bilinguals struggle to maintain contrast between L1 and L2 phonetic categories that are in a shared phonological space. However, if ‘equivalence classification’ (Flege, 1991, 1995) occurs between L1 and L2 sounds, category formation for L2 sounds may be impeded and one category will represent the relevant L1 and L2 sounds. Whether or not equivalence classification occurs is assumed to depend on the perceived phonetic distance between the associated L1 and L2 sounds. In other words, the greater the perceived phonetic distance between the

L1 and L2 sounds is, the more likely it is that the phonetic differences between the sounds will be discerned and in turn, L2 learners will be more likely to establish new L2 phonetic categories.

Similarly, the Perceptual Assimilation Model (PAM) (Best, 1995a, 1995b) addresses the role of phonetic-articulatory details in cross-language speech perception. By comparison with SLM, the PAM is more oriented toward the initial state of the cross-linguistic speech perception. It posits that the perceptual assimilation of non-native sounds to the native phonological system by non-native listeners is affected by the phonetic-articulatory similarities/dissimilarities between the non-native and native sounds.

Whereas these theoretical models addressing the role of perceptual similarity/dissimilarity in cross-linguistic speech perception provide a theoretical ground to the present study, acoustic-phonetic findings on Korean and English stops and a study conducted by Schmidt (1996) provide practical predictions about Korean listeners' cross-linguistic mapping of English stops with Korean stops. As described earlier, English voiceless stops and Korean aspirated stops reside in a similar acoustic space. Above all, both have positive VOT values and are strongly aspirated stops, especially in an utterance-initial position. In H1-H2, vowels following both are characterized as having relatively breathy voicing. And, both are followed by a vowel produced with higher f_0 compared with English voiced stops and Korean lenis stops, respectively. In addition, the result of a perception task conducted by Schmidt (1996), which tested Korean speakers' identification of English consonants in terms of Korean consonant categories, indicated that native Korean speakers consistently labeled English aspirated voiceless stops as Korean aspirated stops. Thus, English voiceless stops and Korean aspirated stops seem very comparable in terms of phonetic acoustic properties and perceptual correspondence.

The comparability between English voiced stops on the one hand and Korean lenis and fortis stops on the other seems to be less clear. Schmidt (1996) reported that native Korean speakers labeled English voiced stops as both Korean lenis stops and fortis stops with roughly equal frequency. And, similarity ratings were lower than those between Korean aspirated stops and English voiceless stops. This labeling behavior seems to originate from the shared acoustic properties between these stop categories. Both Korean fortis stops and English voiced stops are characterized with short-lag VOT, and vowels following these stops are characterized with a relatively more creaky phonation compared with Korean lenis and stops and English voiceless stops, respectively. The mapping relation found between English voiced stops and Korean lenis stops also seems plausible². Although the mean VOT ranges are different from each other, English voiced stops are commonly realized as voiceless unaspirated stops in utterance-initial position. In addition, English voiced stops and Korean lenis stops condition a relatively lower f_0 at the onset of the following vowel than English voiceless stops and Korean aspirated and fortis stops do.

To summarize, the present study deals with two research topics, age of learning effect: if one learns an L2 at earlier age, s/he is more likely to produce the L2 in a more nativelike way, and the nature of the phonological systems in bilinguals: how two phonological systems in bilinguals are organized, separately or in relation to each other. Thus, the study investigates how Korean and English stop systems in Korean (L1)-English (L2) bilinguals interact with each other as a function of age of English learning. Two predictions were made to be tested: First, early bilinguals are more nativelike in their production of English stop consonants and more likely to establish L2 phonetic categories. Second, early bilinguals show less cases of merger of Korean stops with English stops and thus, maintain to greater extent independence between the English and Korean stop systems.

4. Methods

4.1 Participants

The data were collected from 40 adult participants. The participants were divided into four groups: 10 native speakers of English (English monolingual group, hereafter 'NE' group), 10 native speakers of Korean (Korean near-monolingual group³, hereafter 'NK' group), and 20 Korean-English bilinguals. The NK and the bilingual groups were all consisted of 7 female and 3 male participants, and the NE group was consisted of 6 female and 4 male participants. The English monolinguals were students or affiliates of the University of Oregon. The Korean monolinguals were all students at the American English Institute at the University of Oregon who stated that at the time of the experiment they had lived in an English-speaking country for less than 3 months except one participant with 5 months of residence.

The Korean-English bilinguals were divided into two groups based on their age of arrival (AOA) in the United States: 10 'early' bilinguals immigrated to the US with their Korean parents between the ages of 0 – 6 years (mean = 2.2 years, s.d. = 2.3, hereafter 'Early' group), and 10 'late' bilinguals arrived between the ages of 15 – 34 years (mean = 20.3 years, s.d. = 6.4, hereafter 'Late' group).

4.2 Speech material

Due to the cross-linguistic nature of this study, the target sounds, English voiceless and voiced stops, and Korean voiceless aspirated, lenis, and fortis stops were matched in terms of phonological environment where they occur: utterance initial, and preceding a low vowel /a/. This vowel was selected because the first formant has a high frequency, clearly above the first harmonic. This was important for the acoustic measurement of H1-H2 to be described below. Each target word was written on a flashcard in the orthography of each language. To help facilitate the understanding the meaning of the words and thus,

to record production of known words, a sentence contextualizing the target word was presented on the card (Refer to Appendix to see contextualizing sentences for English and Korean words). Also, in order to locate the target words in a constant prosodic environment, each word was embedded in a carrier sentence in an utterance initial position. The English carrier sentence was “_____ is the word.”, and the Korean one was “_____ haseyo.” (‘Say _____’). Three tokens were produced for each of the target words. The context sentences were used to identify the target words during the analysis process. Tables 2 and 3 below show the word lists in a phonemic transcription.

Table 2. Korean stops recorded for acoustic measurements

Aspirated	Lenis	Fortis
p ^h ata ‘to dig’	pata ‘sea’	p [*] ata ‘to grind’
t ^h ata ‘to ride’	tato ‘tea ceremony’	t [*] ata ‘to pick’
k ^h adi ‘card’	kata ‘to go’	k [*] ata ‘to peel’

Table 3. English stops recorded for acoustic measurements

Voiceless	Voiced
p ^h at ‘pot’	bat ‘bot’
t ^h at ‘tot’	dat ‘dot’
k ^h at ‘cot’	gat ‘got’

4.3 Procedure

Each of the participants was recorded using a high quality, head-mounted microphone and a Sony DAT recorder in the Phonetics Lab at the University of Oregon. The speakers read the cards in randomized blocks, three for each language (stop types were mixed for each block). The two groups of Korean-English bilinguals (Early and Late) read both the English and the Korean cards, and this was to examine how L1 (Korean) and L2 (English) interact with each other in bilinguals. As a control group, the English monolingual and the Korean near-monolingual participants read the English and the Korean cards, respectively.

4.4 Measurements

Voice onset time (VOT): The VOT of the initial stop in each target word was measured to the nearest 1 ms from the beginning of the stop release burst to the onset of the periodic portion of the waveform. The onset of the vowel in the waveform was determined by the onset of the first full glottal pulse of the vowel. The onset of the voicing energy in the second formant shown in a time-locked spectrogram was used to help determine voicing onset in conjunction with the wave form.

Fundamental frequency (f_0): F_0 was measured both at the onset and the temporal midpoint of the vowel using the first harmonic values from FFT

spectra with a 32 ms analysis window. A cursor was placed at zero-crossing point in the waveform after the first full glottal pulse for the onset measurement and at the temporal midpoint of the vowel for the midpoint measurement. Arithmetic calculations of frequency ($f = 1/t$) (where f is frequency and t is time) were made as supplementary checks when the value from the spectral view seemed noticeably high or low. The vowel onset was determined by the first full glottal pulse of the vowel corresponding to visible second formant energy in the spectrogram. Because f_0 varies according to each individual, especially across age and gender groups, the measured raw f_0 values were normalized by subtracting the values at the midpoint from the values at the onset of the vowel. Thus, a positive value means a falling f_0 contour across the onset and midpoint of the vowel, and a negative value means a rising f_0 contour. The f_0 values used in the statistical analyses below were these subtracted values, and this normalization allowed direct comparisons between participant groups.

H1-H2 difference: Energy values (dB) for the first (H1) and the second (H2) harmonics were measured at the onset of the vowel, using FFT spectra with a 32 ms window (31 Hz bandwidth). A cursor was placed after the first full glottal pulse in the waveform. The difference in intensity between H1 and H2 is frequently referred to as distinguishing breathy and creaky voicings of the vowel. Breathily voicing is characterized by most energy near f_0 (H1), with a steep falling-off in spectral slope. On the other hand, creaky voicing is produced with more energy in H2 and the higher harmonics. Thus, a greater H1-H2 difference would indicate a more breathy voicing quality, and a smaller or negative H1-H2 difference would indicate a more creaky quality of the voicing. The values submitted for the statistical analyses were ones obtained from the subtraction of values for H2 from values for H1.

5. Results

5.1 Age of learning effects on the production of stop categories: between-group analysis on Korean and English stops

In this section, the extent to which the Early and the Late bilinguals produced a given stop category in a native-like way was examined by comparing these bilingual groups with the relevant monolingual group.

5.1.1 Age of learning effects on the production of English stops

The results of a two-way, Group (NE, Early, Late) by Stop Type (English voiceless, voiced) multivariate repeated measures analysis with the dependent measures of VOT, H1-H2, and f_0 contour returned significant main effects for Group [$F(6, 312) = 8.143, p < .05$] and Stop Type [$F(3, 156) = 249.544, p < .05$]. There was no interaction between these factors ($p > .05$). These results indicate that the groups differed from one another in a consistent manner across stop type.

Further investigation of the main effect of Group using Tukey's HSD tests (p

< .05) on each of the three dependent measures (VOT, H1-H2, f_0 contour) revealed differences between the bilingual and English monolingual groups. As can be seen in Figure 1, the Late bilinguals were different from the English monolinguals in the production of English stops for VOT, H1-H2, and f_0 contour: VOT was longer for both the voiceless and voiced stops, the vowel following a voiceless stop was more breathy, the vowel following a voiced stop was less creaky, and f_0 contour was flatter for the voiceless stops and more rising for the voiced stops. In contrast, the Early bilinguals were not different from the English monolinguals for both English voiceless and voiced stops.

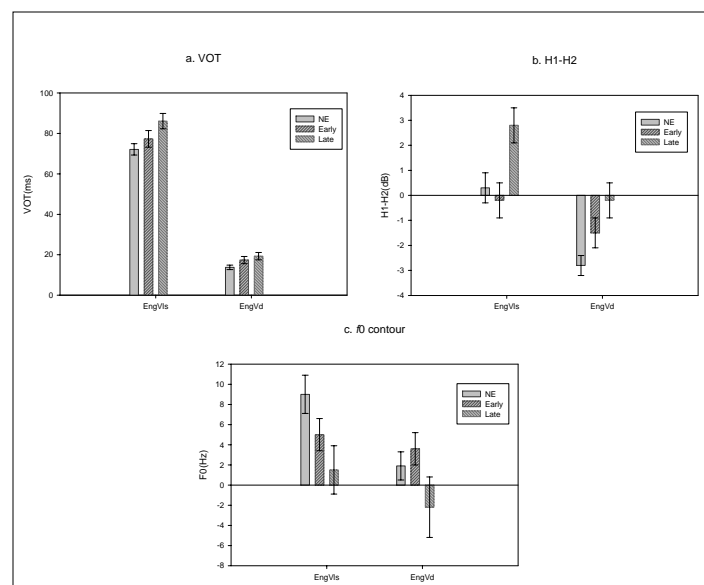

Fig.1 Mean values with standard errors for the production of English stops (voiceless and voiced) for three acoustic parameters (VOT, H1-H2, f_0 contour) by three groups (NE, Early bilinguals, and Late bilinguals)

5.1.2 Age of learning effects on the production of Korean stops

The results of a two-way, Group (NK, Early, Late) by Stop type (Korean aspirated, lenis, fortis) multivariate repeated measures analysis with dependent measures of VOT, H1-H2, f_0 contour returned significant main effects for Group [$F(6, 514) = 3.529, p < .05$], Stop Type [$F(6, 514) = 107.32, p < .05$], and an interaction between Group and Stop Type [$F(12, 680.25) = 2.369, p < .05$]. The results indicate that the group effect depended on stop type. MANOVAs on each stop type ($\alpha = .16$) returned significant group effects for Korean aspirated stops [$F(6, 166) = 2.825, p < .016$] and for fortis stops [$F(6, 170) = 2.728, p < .016$], but not for lenis stops. Pairwise comparison tests on Korean aspirated

and fortis stops revealed that the Early and the Late bilinguals produced the aspirated stops with longer VOT values (Fig. 2a). The Late bilinguals produced the fortis stops with longer VOT values (Fig. 2a) and a less rising f_0 contour (Fig. 2c) than the Korean monolingual group (Tukey's HSD, $p < .05$).

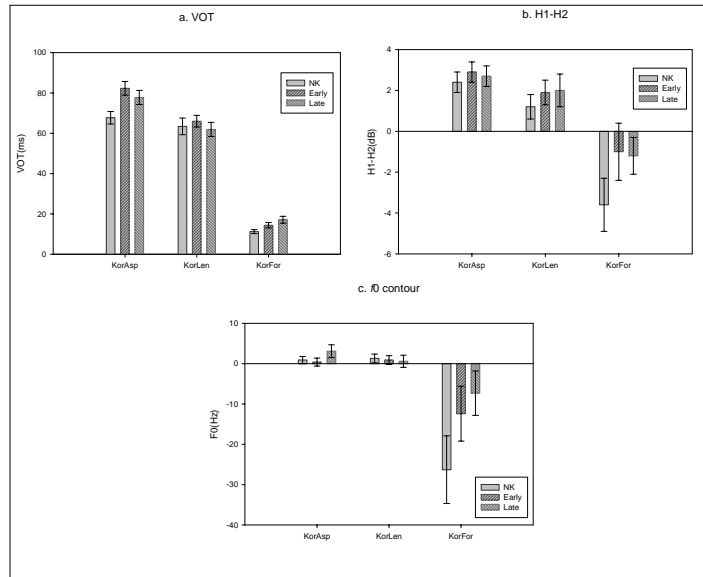

Fig.2 Mean values with standard errors for the production of Korean stops (aspirated, lenis and fortis) for three acoustic parameters (VOT, H1-H2, f_0 contour) by three groups (NK, Early bilinguals, and Late bilinguals)

5.2 Age of learning effects in the degree of independence between two stop systems: within-group analysis on English and Korean stops

In this section, answers to the second question of this study were pursued: do age of learning effects exist between early and late bilinguals in the extent to which two phonological systems are held independent from each other. To this end, the grouping patterns of the five stop categories of Korean and English were examined. An overall repeated measures MANOVA on VOT, H1-H2, and f_0 contour with factors of Stop type (Korean aspirated, lenis, and fortis stops and English voiceless and voiced stops), Group (Early, Late) revealed a main effect of stop type [$F(12, 47) = 158.105, p < .05$] and an interaction of stop type and group [$F(12, 47) = 3.953, p < .05$]. These results indicate that the effect of stop type varied depending on group. Then, to further investigate, within each group, how the five stop categories were separated in relation to one another, 10 pairwise comparisons were made: one comparison of English stop types, three

comparisons of Korean stop types, and six combined comparisons of English and Korean stop types.

5.2.1 *Early group*

The results of the multivariate pairwise comparisons with the dependent variables of VOT, H1-H2, and f_0 contour revealed significant differences for the 10 comparisons ($p < .005$). The Early bilingual group had five distinct stop types in their combined Korean-English systems. English voiceless, English voiced, Korean aspirated, Korean lenis stops, and Korean fortis stops formed a group by themselves.

5.2.2 *Late group*

The multivariate pairwise comparisons with the dependent variables of VOT, H1-H2, f_0 contour returned results of no significant differences for the English voiced and Korean fortis stop comparison and the English voiceless and Korean aspirated stop comparison. The other eight comparisons showed significant differences between the two stop types ($p < .005$). The Late bilingual group had three distinct stop types in their combined Korean-English systems. English voiceless and Korean aspirated stops formed one group. English voiced and Korean fortis stops formed another group. And, the Korean lenis stops formed a group by themselves.

In summary, the results of within-group suggested age of learning effects in the extent of independence between the two stop systems. The Early bilinguals maintained a greater extent of independence between the Korean and English stop systems: the Early bilinguals maintained a separation between English voiceless and Korean aspirated stops and also, between English voiced and Korean fortis stops, whereas the Late bilinguals did not.

6. Discussion: combined results of between- and within-group analyses

In this section, by integrating results of the between-group analysis (to test the extent of nativelikeness of stop production) and the results of the within-group analysis (to test the extent of independence between two stop systems) and looking into the details of production of the stops by the bilinguals, whether L2 categories were formed independently from L1 categories or two L1 and L2 categories merged with each other is considered.

As the between- and within-group analyses showed, the Early bilinguals was not different from the English monolinguals for both English voiced and voiceless stops and at the same time, they maintained five distinct stop types in their stop systems. Thus, the Early bilinguals seem to have established English voiced and voiceless stop categories independently from the Korean stop categories.

In contrast to these results for the Early bilinguals, integrated examination of

the results suggests a merger of English voiceless stops with Korean aspirated stops in the Late bilinguals' stop systems. The between-group analysis showed that the Late group's English voiceless stops were different from those of the NE group in VOT, H1-H2, and f_0 contour, and Korean aspirated stops were different from the NK group in VOT. At the same time, in the within-group analysis, their English voiceless stops and Korean aspirated stops grouped together. Together with these overall results, considering of the specifics of production of these stops shows the sign of merger of the two stop categories. For H1-H2, the Late group's mean value for English voiceless stops was 2.8 dB and this mean value is significantly different from that of the NE group, 0.3 dB. This mean value is also very close to the mean value for Korean aspirated stops: 2.7 dB for the Late and 2.4 dB for the NK group. Thus, these results indicate that the Late bilinguals produced vowels following English voiceless stops with a similar breathy quality to Korean aspirated stops. Also, for f_0 contour, the Late group's mean value for English voiceless stops was 1.5 Hz and this was significantly lower than that of the NE group, 9.0 Hz. This far more flat contour pattern was also found for Korean aspirated stops: 3.1 Hz for the Late group, and 0.9 Hz for the NK group.

This inclination to values of Korean aspirated stops is affirmed in VOT values as well. The Late group's mean value for English voiceless stops was 86.1 ms, and this was significantly greater than that of the NE group, 72.1 ms. This greater VOT value is also found in the Late group's own production of Korean aspirated stops, 77.8 ms: the Late group's production of Korean aspirated stops was greater than that of the NE group (mean = 67.7 ms). Thus, examination of the specifics of Late group's production of English voiceless and Korean aspirated stops suggests that English voiceless stops have become similar to Korean aspirated stops in the stop systems of the Late bilinguals.

The combined examination of the between- and within-group analyses suggests another case of merger. In the results of the between-group analysis, the Late group's English voiced stops were different from those of the NE group in H1-H2, and Korean fortis stops were different in VOT and f_0 contour from the NK group. And, the within-group analysis showed that English voiced stops and Korean fortis stops were not separated from each other ($p > .005$). Together with these overall results, considering of specifics of production of English voiced and Korean fortis stops suggests that in the stop system of the Late bilinguals, Korean fortis stops and English voiced stops merge with each other. Examination of the specifics of production of these stops indicates that the mean values have become similar to each other between the voiced stops and fortis stops. The Late group's VOT for English voiced stops (mean=19.3 ms) was greater compared with that of the NE group (mean= 13.8 ms). And, its VOT for Korean fortis stops (mean=17.1 ms) was also greater than that of the NK group (mean= 11.2 ms). For H1-H2, the mean for the Late group's English voiced stops (mean = -0.2 dB) indicated more modal voicing than that of the NE group

(mean = -2.9 dB), and its mean for Korean fortis stops (mean = -1.2 dB) also represented more breathy voicing than the NK group's fortis stops (mean = -3.6 dB). And, for f_0 contour as well, the mean values were similar to each other. The Late group's negative mean value for English voiced stops (mean = -2.2 Hz) indicated a rising contour in contrast to the falling contour of both the NE group (mean = 1.9 Hz) and the Early group (mean = 3.6 Hz). The Late group's mean for Korean fortis stops was -7.3 Hz, and this mean represented a far more similar value to the -2.2 Hz of the voiced stops in contrast to the NK group's -26.3 Hz. Thus, examination of the specifics of production suggests that English voiced stops and Korean fortis stops have become similar to each other in the stop systems of the Late bilinguals.

To summarize, the results of the combined examination of the between- and within-group analyses suggested that the Early bilinguals have formed English voiced and voiceless stop categories. In contrast, the Late bilinguals seem to have merged English voiceless stops with Korean aspirated stops and English voiced stops with Korean fortis. Their English voiceless stops were similar to Korean aspirated stops, and English voiced stops and Korean fortis stops were similar to each other.

7. General discussion

This study investigated the interaction of Korean and English stop systems in Korean-English bilinguals as a function of age of L2 learning. The results of the between- and within-group analyses suggested that the Early bilinguals established L2 phonetic categories for English voiceless and voiced stops independently from the Korean stop categories, whereas the Late bilinguals merged Korean aspirated stops with English voiceless stops and Korean fortis stops with English voiced stop.

These findings can be interpreted within the framework of the SLM. According to the SLM, a language interaction model, interaction of L1 and L2 sounds can be described with two distinctive mechanisms of category assimilation or dissimilation. Category assimilation is assumed to operate when category formation for a new L2 sound is blocked by the presence of a similar L1 sound. Instances of L2 category continue to be identified as instances of an L1 category and thus, a "merged" category develops over time. The second mechanism, category dissimilation is thought to operate when category formation for a new L2 sound is successful. Category dissimilation occurs because bilinguals strive to maintain phonetic contrast between the newly formed L2 category and the nearest L1 category that reside in a shared phonetic space.

Also, the SLM posits that age of learning effects derive primarily from how the interaction of L1 and L2 phonetic system changes as age of L2 learning increases. Thus, it is predicted that early bilinguals will be more likely to form new phonetic categories for L2 sounds than late bilinguals will be. However,

what remains to be explained is why such changes in “how L1 and L2 systems interact” occur as a function of age of learning. With respect to this, another hypothesis of the SLM, “the likelihood of L2 category formation varies inversely according to the degree of perceived dissimilarity from the closest L1 sound” seems to provide some insight into this question. In other words, it is posited that the greater the perceived phonetic distance between the L1 and L2 sounds is, the more likely it is that the phonetic differences between the sounds will be discerned and in turn, L2 learners will be more likely to establish new L2 phonetic categories.

The discrepancy between the Early and the Late groups regarding the category formation for English voiceless stops can be interpreted in terms of difference in degree of perceived phonetic distance between the associated categories of English voiceless stop and Korean aspirated stops. That is, the Early bilinguals may have perceived a greater distance than the Late bilinguals. In contrast, the Late bilinguals may have identified instances of the category of English voiceless stops as Korean aspirated stop and thus a merged category may have developed for these two stop types. To borrow terminology from the SLM, the “category assimilation” mechanism may have operated. This interpretation is partially supported by the findings of Schmidt’s (1996) experimental study: listeners who had longer exposure to English showed an overall lower mean similarity rating for English sounds to Korean sounds.

The production results of Korean stops also suggest an interaction of the two stop systems in the bilinguals. As reported earlier, the Late bilingual group showed difference from the Korean monolinguals for the fortis stops in VOT and f_0 contour and for the aspirated stops in VOT values. The Early bilingual group showed a difference for the aspirated stops in VOT values. Evaluation of the specifics of the production of the fortis stops by the bilinguals seems to suggest that the Late bilinguals’ production of the fortis stops is more likely to have been influenced by the interaction with English voiced stops than the Early bilingual’s production was. The Late group’s production of the fortis stops was more deviant from the monolingual Koreans’ production than the Early group in terms of mean values in VOT, H1-H2, and f_0 contour: 16.6 ms vs. 14.2 ms for the 11.2 ms of the monolinguals, -1.2 dB vs. -2.2 dB for the -3.6 dB of the monolinguals, and -6.8 Hz vs. -12.4 Hz for -26.3 Hz of the monolinguals. The results may be attributed to lower degree of independence of the fortis stops with the English voiced stop category for the Late bilinguals. When considering the higher L1 (Korean) use of the Late bilingual group (see section 4), more deviant production from native Korean norms by this group may be surprising. However, if we assume that interaction of two sub-phonetic/phonological systems is affected by age of L2 learning, we may predict that the Early bilinguals maintain a higher degree of independence between the systems. Thus, the Late group’s more deviant production of the fortis stops may be a result of reduced independence between the L1 and L2 systems.

Regarding the perceptual mapping relations reported in Schmidt (1996) between English voiced stops and Korean lenis and fortis stops, an emerging question is why only the fortis stops, not the lenis stops were deviant from the monolinguals in the production of the Late bilinguals. Some of the possible answers to this question may include markedness. Kehoe *et al* (2004) hypothesizes that marked phenomena in a language may require considerable amount of time to be consolidated but once they are automatized, they are resistant to the influence of a foreign language. Thus, considering the fact that the lenis stops are on the sort of ‘low-long lag’ in VOT values on the continuum of the extremely short lag fortis stops and long-lag aspirated stops for the instances of individual values, it could be speculated that this category may be relatively hard to be established and in turn, the lenis stops are less permeable to the influence of English than the fortis stops are. In fact, although anecdotal, it is commonly observed that American English learners of Korean experience the greatest difficulties with the lenis stops for the distinctive production of the three types of Korean stops. To summarize, the interpretations discussed so far support the position (e.g. Flege *et al*, 2003; Grosjean, 1989) that the L1 and L2 phonetic/phonological subsystems of a bilingual cannot be completely separated.

What should be noted additionally from the results of the present study is that early bilinguals who began to learn an L2 from early childhood seem to distinguish two phonological categories in L1 and L2 with fine-grained phonetic differences. That is, the Early bilinguals seem to maintain two separate categories of English voiceless stops and Korean aspirated stops, whereas the Late bilinguals who began to learn an L2 after adolescent failed to do this. As described earlier, English voiceless stops and Korean aspirated stops are highly alike phonetically and perceptually. This result supports Guion’s (2003) proposal that fine-grained phonetic information is key to a rigorous, empirical investigation of bilingual phonological systems. It also supports Khattab’s (2002, p. 3) statement that how bilingual children manage to learn language specific phonetic level details of their languages has been the focus of many studies on bilingual children.

In summary, the present study showed that age of learning effects are observed in the interaction of phonological systems of bilinguals. In this observation, the role of perceptual similarity/dissimilarity in L2 speech learning was affirmed. Also, the observed differences in L2 category formation between the Early and the Late bilingual groups supported the proposal made by the SLM. That is, the ability to learn L2 speech remains intact throughout the life, but the likelihood of perceiving phonetic differences between L1 and L2 sounds decreases as age of learning increases, and thus, early bilinguals will be more likely to establish new phonetic categories for L2 speech sounds than late bilinguals. In addition, the results of the Early bilinguals ‘distinctive’ production of English voiceless stops from Korean aspirated stops and the Late bilinguals’ merger of these categories suggested that developmental changes should occur in ability to acquire L2

sounds and that some aspect of L2 speech may not be able to be acquired even with a considerable amount of exposure to the L2.

Notes

1. These studies excluded the occasional prevoiced stops in the means for voiced VOT values. The current study also did not include negative VOT values for comparing the total mean VOT of English voiced stops for monolingual and bilinguals participants.
2. This mapping pattern may also be related to Romanization convention in Korea of English voiced stops being transcribed with Korean lenis stops.
3. The speakers learned English in middle school and high school. However, they never used English on daily basis and did not have a functional command of English.

References

- Ahn, H. 1999. *Post-release phonatory processes in English and Korean: acoustic correlates and implications for Korean phonology*. Doctoral dissertation, University of Texas at Austin.
- Best, C. T. 1995a. 'Learning to perceive the sound pattern of English,' In Rovee-Coller (Ed.), *Advances in infancy research*. Vol. 9, (pp. 217-304). Hillsdale, NJ: Ablex Publishers.
- Best, C. T. 1995b. 'A direct realist perspective on cross-language speech perception,' In Strange (Ed.), *Speech perception and linguistic experience: issues in cross-language research* (pp. 171-204). Timonium: York Press.
- Cho, T., S.-A., Jun, and P., Ladefoged. 2002. 'Acoustic and aerodynamic correlates of Korean stops and fricatives,' *Journal of Phonetics*, Volume. 30: 193-228.
- Flege, J. 1991. 'Age of learning affects the authenticity of voice-onset time in stop consonants production in a second language,' *Journal of the Acoustical Society of America*, Volume. 89: 395-411.
- Flege, J. 1995. 'Second-language speech learning: theory, findings, and problems' In Strange (Ed.), *Speech perception and linguistic experience: issues in cross-language research* (pp. 233-277). Timonium: York Press.
- Flege, J., C., Schirru, and R. A., MacKay. 2003. 'Interaction between the native and second language phonetic systems,' *Speech Communications*, Volume. 40: 467-491.
- Flege, J., I., Mackay, and D., Meador. 1999. 'Native Italian speakers' perception and production of English vowels,' *Journal of the Acoustical Society of America*, Volume. 106: 2973-2987.
- Grosjean, F. 1989. 'Neurolinguistics, beware! The bilingual is not two monolinguals in one person,' *Brain and Language*, Volume. 36: 3-15.
- Guion, S. 2003. 'The vowel system of Quichua-Spanish bilinguals: Age of acquisition effects on the mutual influence of the First and second language,' *Phonetica*, Volume 60: 98-128.
- Guion, S., J., Flege, R., Akahane-Yamada, and J., Pruitt. 2000. 'An investigation of current models of second language speech perception: The case of Japanese adults' perception of English consonants,' *Journal of the Acoustical Society of America*, Volume. 107: 2711-2724.
- Harada, T. 2003. 'L2 influence on L1 speech in the production of VOT.' *Proceedings of 15th International Conference of Phonetic Sciences at Barcelona*, 1085-1088.

- Kagaya, R. 1974. 'A fiberoptic and acoustic study of Korean stops, affricates, and fricatives,' *Journal of Phonetics*, Volume. 2: 161-180.
- Kehoe, M., C., Lleó, and M., Rakow. 2004. 'Voice onset time in bilingual German-Spanish children,' *Bilingualism: Language and Cognition*, Volume. 7: 71-88.
- Khattab, G. 2002. 'VOT production in English and Arabic bilingual and monolingual children,' In D. E. Parkinson & E. Benmamoun (Eds.), *Perspectives on Arabic Linguistics XIII-XIV* (pp. 1-38). Amsterdam: John Benjamins.
- Kim, M. -R. Cho. 1994. *Acoustic characteristics of Korean stops and perception of English stop consonants*. Doctoral dissertation, University of Wisconsin at Madison.
- Kim, M. R., P. S., Beddor,., and J., Horrocks, 2002. 'The contribution of consonantal and vocalic information to the perception of Korean initial stops,' *Journal of Phonetics*, Volume. 30: 77-100.
- Klatt, D. H. 1975. 'Voice onset time, frication and aspiration in word-initial consonant clusters,' *Journal of Speech and Hearing Research*, Volume. 18: 686-705.
- Lisker, L., and A. S., Abramson. 1964. 'A cross-language study of voicing in initial stops: acoustical measurement,' *Word*, Volume. 20: 384-422.
- Mackay, I., J., Flege, T., Piske, and C., Schirru. 2001. 'Category restructuring during second-language acquisition,' *Journal of the Acoustical Society of America*, Volume. 110: 516-528.
- Munro, M., J., Flege, and I., Mackay. 1996. 'The effects of age of second-language learning on the production of vowels,' *Applied psycholinguistics*, Volume. 17: 313-334.
- Piske, T., I., Mackay, and J., Flege. 2001. 'Factors affecting degree of foreign accent in an L2: a review,' *Journal of Phonetics*, Volume. 29: 191-215.
- Piske, T., J., Flege, I., Mackay and, D., Meador . 2002. 'The production of English vowels by fluent early and late Italian-English bilinguals,' *Phonetica*, Volume. 59: 49-71.
- Schmidt, A. 1996. 'Cross-language identification of consonants. Part 1. Korean perception of English,' *Journal of Acoustical Society of America*, Volume. 99: 3201-3211.
- Shimizu, K. 1996. *A cross-language study of voicing contrasts of stop consonants in Asian languages*. Tokyo: Seibido Publishing.
- Sundara, M., L., Polka, and S., Baum. Production of coronal stops by adult bilingual first language learners of Canadian English and Canadian French: Language-specific and language-general constraints (unpublished manuscript)

Appendix

1. English target words and context sentences
- 'pot': We made soup in the pot.
- 'bot': bot is short for robot.
- 'tot': The child was such a cute tot.
- 'dot': There was a small dot of ink on the paper.
- 'cot': She slept on the foldout cot.
- 'got': He got many presents for his birthday.

2. Korean target words and context sentences

파다 /p^hata/ ‘to dig’

민지가 구덩이를 팠어요.

/Mincika kudengilul p^hasseyo/ ‘Minji dug a hole’

바다 /pata/ ‘sea’

민지가 어제 바다에 갔어요.

/Mincika ece patae kasseyo/ ‘Minji went to sea yesterday’

빨다 /p^{*}ata/ ‘to grind’

엄마가 고추를 빨았어요.

/Emmaka koc^hulul p^{*}ahasseyo/ ‘Mom ground peppers’

타다 /t^hata/ ‘to ride’

민지가 택시를 탔어요.

/Mincika t^haeksilul t^hasseyo/ ‘Minji took a taxi’

다도 /tato/ ‘tea ceremony’

민지가 지난 여름에 다도를 배웠어요.

/Mincika cinan yelume tatolul paewesseyo/ ‘Minji learned tea ceremony last summer’

따다 /t^{*}ata/ ‘to pick’

민지가 사과를 따했어요.

/Mincika sagwalul t^{*}asseyo/ ‘Minji picked an apple’

카드 /k^hadi/ ‘card’

민지가 어제 생일 카드를 샀어요.

/Mincika ece saengil k^hadulul sasseyo/ ‘Minji bought a birthday card yesterday.’

가다 /kata/ ‘to go’

민지가 어제 서울에 갔어요.

/Mincika ece Seoule kasseyo/ ‘Minji went to Seoul yesterday.’

까다 /k^{*}ata/ ‘to peel’

민지가 엄마와 밤을 껐어요.

/Mincika Emmawa pamul k^{*}asseyo/ ‘Minji peeled nuts with her mom’

A Case-study on the Accusative Case in Turkish

F. Nihan Ketrez

University of Southern California

1. Introduction

This is a case-study conducted on a monolingual Turkish child's accusative case omission errors recorded before the age 2;0. The goal of the study is to show that the absence of obligatory object case morphology in the subject's speech does not result from a syntactic deficiency. In contrast, the errors have a pattern that shows that the child's grammar is governed by syntactic constraints that are similar to the ones in operation in adult speech.

1.1 The accusative morphology, specificity and word order

In Turkish, specific objects (definite and specific indefinite) which include pronouns and proper names, obligatorily bear overt case morphology, and scramble freely; while non-specific objects do not have overt case morphology and occur in the immediately preverbal position (Erguvanlı 1984, Enç 1991, Kural 1992 among others). The sentences in (1), (2) and (3) exemplify specific and non-specific objects respectively. Bare object+verb constructions, which are analyzed as incorporation, pseudo-incorporation or lexical compounding cases (See Öztürk (2004) and the references therein) appear in the immediately preverbal position without case marking and do not scramble (4).¹

- (1) Definite
- | | | |
|----|----------------------------------|-----|
| a. | Alex elma-yı ye-di. ¹ | SOV |
| | Alex apple-acc eat-past | |
| | 'Alex ate the apple.' | |
| b. | Alex ye-di elma-yı. | SVO |
| c. | Elma-yı Alex ye-di. | OSV |
- (2) Indefinite, specific
- | | | |
|----|-------------------------------|-----|
| a. | Alex bir elma-yı yedi. | SOV |
| | Alex a/one apple-acc eat-past | |

- 'Alex ate one of the apples.'
- b. Alex ye-di bir elma-yı. SVO
c. Bir elma-yı Alex ye-di. OSV
- (3) Indefinite, non-specific
- a. Alex bir elma-Ø ye-di SOV
Alex a/one apple eat-past
'Alex ate an apple.'
- b. *Alex ye-di bir elma-Ø. SVO
c. *Bir elma-Ø Alex ye-di. OSV
- (4) Bare object
- a. Alex elma-Ø ye-di SOV
Alex apple eat-past
'Alex apple-ate.'
- b. *Elma-Ø Alex ye-di SVO
c. *Alex ye-di elma-Ø. OSV

Common nouns can appear with or without case and have specific or non-specific interpretation depending on the absence or presence of case morphology. The types of (specific) objects that obligatorily get case are pronouns (5), wh-words (6), proper names that are the names of specific people or places (7), common noun phrases with relative clauses (8) and demonstratives (9), and those that bear possessive morphology (10).

- (5) Alex o-nu/*-Ø gör-dü.
Alex he-acc see-past
'Alex saw him.'
- (6) Alex kim-i/*-Ø gör-dü.
Alex who-acc see-past
'Whom did Alex see?'
- (7) Alex Hasan-ı/*-Ø gör-dü.
Alex Hasan-acc see-past
'Alex saw Hasan.'
- (8) Alex Hasan-ın al-dığı arabayı / *-Ø gör-dü.
Alex Hasan-gen buy-rel-poss&3S car-acc see-past
'Alex saw the car that Hasan bought.'
- (9) Alex bu arabayı / *-Ø gör-dü.
Alex this car-acc see-past

'Alex saw this car.'

- (10) Alex arabası-**m**/*-Ø gör-dü.
 Alex car-poss&3S-acc see-past
 'Alex saw his car.'

In the literature, proper names are reported as object types that are obligatorily case marked. However, in natural speech they can have a non-specific interpretation in sentences such as *listening to Mozart* (11) or *watching Mickey Mouse* (movie) (12) and occur without case. In such examples, the reference of the proper name is not the actual person, but any piece composed by Mozart or any member of the Mickey Mouse series. When the intended meaning is the actual person, listening to the actual person talking, for example, the object has to bear overt case morphology, or when 'Mozart' is one of the alternatives, thus a member of a set, it has to have overt case morphology.

- (11) Alex Mozart-Ø dinli-yor.
 Alex Mozart-Øacc listen-prog
 'Alex is listening to Mozart.'
- (12) Alex Miki Fare-Ø seyred-iyor.
 Alex Mickey Mouse-Ø watch-prog
 'Alex is watching Mickey Mouse.'

Another exception to the case-realization generalization is the wh-word 'what,' which can appear without overt case morphology when it substitutes objects that have a non-specific interpretation. It can appear with case morphology as well, when the intended reference is a specific object, similar to 'which one'.

- (13) Alex ne-Ø / ne-yi seyred-iyor?
 Alex what-Ø / what-acc watch-prog
 'What/which one is Alex watching?'

There is a close relationship between the realization of case morphology and the specificity of the object. Objects that have a non-specific reference do not bear the accusative case. Specific objects bear case morphology and scramble freely. Generics, which are not necessarily case marked, and which can scramble without case morphology are the only exceptions.

1.2 Children's case

Turkish is known to be one of those languages whose morpho-syntax is acquired very early (Aksu-Koç & Slobin 1985, among others). Children acquiring Turkish syntax have strikingly less number of errors in their speech when

compared to children acquiring other languages (Slobin, 1985). Accusative case morphology is among the earliest acquisitions. Children master the case morphology in obligatory (*i.e.*, scrambled) contexts before the age 1;6, *i.e.*, no omission is seen in scrambled positions (Ekmekçi, 1986). Earlier studies also showed that children use the accusative case as a cue to detect the grammatical function (subject vs. object) of words (Bever & Slobin 1982).

Earlier studies done on children's case marking focused on the question of whether or not children marked objects in *scrambled* positions, and they showed that they did at a very early age. Children's early mastery of scrambling/case marking is considered an early evidence for configurationality (Kornfilt, 1994). No study has concentrated in detail on the case omission errors, which are considered to be rare and highly exceptional.

In more recent studies on the acquisition of indefinite objects, Ketrez (2004a, b,c) showed that children could not differentiate case marked versus non-case-marked objects and they did not necessarily have a specific interpretation of the accusative marked objects. *i.e.*, in around 80% of the instances they interpreted accusative marked objects as non-specific (Ketrez 2004c).

In summary, earlier studies showed that children could produce the accusative case in obligatory contexts, but they did not have adult-like interpretation of the case marked objects. In other words, the child grammar allowed accusative-marked non-specific objects. In the present study, I address to the question of whether or not they can have non-case-marked specific objects as well. I discuss the findings in relation to the early syntactic representations in child grammar.

2. Method

Spontaneous speech samples of a monolingual Turkish child was recorded longitudinally between the ages 1;3-2;0 with 20 days intervals³. All multi-word utterances that contained a verb and a direct object were targeted for analysis. Object+Verb combinations were studied with a particular focus on the accusative case omission errors and the position of the object with respect to the verb. The three positions that were analyzed were 1- preverbal adjacent to verb (PreV-Adj), 2- preverbal non-adjacent to verb (PreV-NonAdj) and 3-postverbal (PostV). Proper names, pronouns and contextually specific common noun objects were included in the analysis.

3. Results

The accusative case was recorded at the age of 1;3, which was the first session recorded, but the productive use of nominal morphology took place only around the age of 1;6. (Ketrez 1999 and subsequent work). The first two-word utterances contained a subject/a vocative and a verb and were recorded before 1;6. The first object+verb utterance was observed at 1;6. In total, 528

object+verb utterances were recorded during the period analyzed. 465 of these objects (89%) occurred in the PreV-Adj position, 13 of them (2.4%) were in PreV-NonAdj positions and 48 of them (9%) occurred postverbally. 283 of the preverbal objects (55%) were not case-marked. Therefore the majority of the objects occurred in the preverbal position, which is the canonical position for an object². Scrambling to postverbal position was more common than scrambling in a preverbal non-adjacent position.

22 (8%) of the case omissions were recorded in contexts where case morphology was obligatory. In other words, they were clearly ungrammatical. The others were analyzed as grammatical omissions if the intended meaning could be interpreted as non-specific, as in the case of the example in (14). In this example, the sentence without a case reads as 'I did doll covering' and it is grammatical with this intended meaning. However, contextually it would be more appropriate to use an accusative marked version of the object because there was only one definite doll she has in her hand. It is also possible that the child was intending a specific reference, the particular doll that she was playing with rather than a general doll-covering event and omitting the case. Because such examples are hard to evaluate, they were not included in the ungrammatical category and the discussion focused on the clear cases where the omission is clearly ungrammatical.

(14) A grammatical case omission (common noun):

CHI: **bebek** ö:t-tü-m.
doll-Øacc cover-PAST-1S
'I covered (a/the?) doll'

MOT: aa bebek ört-müs kız-ım.
oh doll-ØACC cover-PERF daughter-poss&1S
'oh my daughter covered (a/the?) doll'

A similar kind of ambiguity is seen in the use of proper names. In (15), she wants her mother to draw a picture of Būdū, a Sesame Street character. The sentence is grammatical without a case marker with the intended meaning 'draw a (picture of) Būdū' or 'any picture of Būdū.' Such examples, too, are analyzed as grammatical case omission cases although they could be ungrammatical omissions. Only 13% of the proper names were marked with the accusative case in the preverbal position and had a specific interpretation. Majority of the proper names was produced without a case marker, and had a non-specific interpretation. These examples, too, as it is the case with the common nouns, are hard to evaluate in terms of the child's real intention. It is possible that she had a specific reading of the non-case marked object. The possibility of examples such as (17), where the case omission is ungrammatical on proper names, suggest that she might be omitting the case although the intention was a specific reading.

- (15) A grammatical case omission (proper noun)
 CHI: Būdū yap.
 Būdū make (=draw)
 'Draw Būdū'

The examples for the utterances that were clearly ungrammatical are given in (16), (17), (18) and (19). In (16), she produces the accusative case in the post-verbal position, and omits it when the object occurs pre-verbally. In (17), she omits case in another obligatory position: a proper noun. Similarly in (18), a demonstrative pronoun lacks case in the preverbal position and in (18) another specific object lacks case morphology.

- (16) İtti-yoy-um **bu-nnay-ı**, **bu-nnay-Ø** vey [age: 1;10,3]
 want-prog-1S **this-plu-acc this-plu*-Øacc** give.
 'I want these, give these (to me)'
- (17) **Lale-Ø** anlat. [age: 1;10,3]
Lale-*-Øacc tell/narrate
 'Talk about Lale (literally: Tell Lale)'
- (18) Ayı-cık **bu-Ø** deyred-iyo [age: 1;11,23]
 bear-dim **this-*-Øacc** watch-prog
 'The little bear is watching this'
- (19) **Du kıymtı-Ø** vey-iy mi-tin? [age: 1;10,3]
 That **red-*-Øacc** give-aorist que-2S
 'Could you give (me) that red (one)?'

Thus the specific or definite objects were not necessarily case marked in the child's speech. Even those grammatical utterances that have a non-referential interpretation may be case omission instances. When objects (specific or non-specific) were not case marked, they occur in the preverbal position, i.e., no case omission error is observed in scrambled positions (post-verbal or preverbal). Table 1 summarizes the use and omission of the accusative case in three positions.

Table 1: Grammatical production and omission of the accusative case

	PreV-Adj			PreV-NonAdj			PostV		
	Ø	*Ø	acc	Ø	*Ø	acc	Ø	*Ø	acc
CN	192	7	39	0	0	3	2 ⁵	0	13
PN	17	3	2	0	0	2	0	0	11

PRO	0	12	78	0	0	5	0	0	23
Wh	46	0	49	0	0	0	0	0	0
QNP	5	0	0	0	0	0	0	0	0
N+poss	0	0	15	0	0	3	0	0	1
Total	260	22	183	0	0	13	2	0	48

4. Analysis

In adult speech, object case can be omitted in the immediately preverbal position. In other words, preverbal position is a legitimate position for case omissions. However, in adult speech, only the non-specific objects are allowed without overt case morphology in this position. As seen in the ungrammatical examples, in this child's speech, pronouns, proper names, and other specific objects can appear without case as well.

I propose that children and adults have the same syntactic structures and their production is restricted by the same syntactic principles. In adult speech, however, specific objects obligatorily bear case morphology. In child speech, the requirements are more flexible: Specific objects can lack overt case. What is deficient, then, is the language specific constraint that the specific objects have to be case-marked overtly. In many languages such as English, specificity is not marked overtly and the specificity interpretation is heavily based on the contextual cues. In this child's speech too, we see an example of a lack of overt marking.

Such a proposal predicts that the omission errors are seen at a later developmental phase, when the child's speech already provides evidence for adult-like syntactic operations and when the child can produce other nominal or verbal morphology correctly. The evidence comes from a study that analyzes the same child's nominal morphology development. Ketrez & Aksu-Koç (2004) shows that the child's morphological development reaches a stability period around the age 1;9. The case omission errors reported in this study are observed after 1;8, as predicted by the proposal, at a later developmental stage.

Another evidence for the proposal is that her speech provides evidence that she can produce case morphology correctly, as well, in preverbal and non-preverbal positions. Case omission errors are observed in 8% of the obligatory contexts, as discussed above. So she can produce case morphology in 92% of the cases. As also predicted by the proposal, omission of other nominal morphology, which is not necessarily associated with specificity, is less common during the period analyzed especially after 1;9. As predicted, Dative, Locative, Instrumental and Comitative case omissions are less frequent, Ablative and plural morpheme omissions are never recorded. Moreover, as seen in Table 2, the number of omissions in other nominal morphology decreases in the period between 1;9 and 2;0 (the second half of the table) while an increase is observed in the accusative omissions.

Table 2: Grammatical use and omission of nominal morphology

		acc ⁶	dat	loc	abl	ins / com	gen	poss	plu
GramUse	1	112	50	83	7	3	47	37	10
*Ø		4	8	2	0	2	13	11	0
*Ø%		3.4%	14%	2.3%	0%	40%	13%	22	0%
GramUse	2	202	190	153	45	26	114	197	6
*Ø:		21	8	0	0	0	3	2	0
*Ø%		9.4%	4%	0%	0%	0%	2.5%	%1	0%

In summary, the omission pattern the child follows suggests that she is omitting case in positions that are possible case omission positions. The properties of the case omissions and her morpho-syntax during the period analyzed suggest that her non-adultlike behavior with respect to the accusative case morphology is not due to her syntactic development.

5. Discussion and Conclusion

I argued that the accusative case omission errors observed in a Turkish child's speech did not result from a syntactic deficiency. In contrast, I proposed that the pattern of the errors shows that the child's grammar was very similar to the adult grammar. The evidence was based on the observation that the omission errors were observed in a position where caseless objects could occur in adult speech. Based on the grammatical use of the case morphology in scrambled positions in early child speech, Kornfilt (1994) already argued for an early configurational grammar for Turkish. In the present study, I suggested that the absence of case in this particular position, just as its grammatical production in scrambled positions, provided evidence for an early adult-like syntactic structure. In this way, the present study presented a case where a child's systematic omission errors, rather than the systematic use of morphemes, present evidence for their existence in the representation (*c.f.* Borer & Rohrbacher, 2003).

The present findings are similar to the arguments in Gürel (2002) and Haznedar (2003), who study adult and child SLA of case morphology in Turkish and argue that the absence of case does not result from a syntactic deficiency. The findings reported here are similar to the findings reported in other scrambling languages such as Japanese as well. Japanese children, too, drop case (accusative and nominative) only in positions that are legitimate for case omission in adult speech. The only difference is that children omit case more frequently (Otsu 1994; Miyamoto et al. 1999, among others).

I proposed that what was non-adult-like in child grammar was the absence of specificity marking through case morphology. The strongest evidence for this was the omission of the accusative case on the obligatory contexts (e.g.,

pronouns, which are specific by definition). Such a proposal is in line with the arguments for the acquisition of the specific objects and direct object scrambling in Dutch. According to Schaeffer (1997, 2000), for example, specificity *marking* is optional in young children acquiring Dutch. Children, around the age 2;0 years do not scramble specific/definite objects, including pronouns, although scrambling of specific objects is obligatory in adult grammar. Schaeffer attributes the children's behavior to a late acquisition of a 'discourse rule' which obligates specificity *marking*. In the present study, too, I argued that the Turkish child that I studied did not necessarily mark specificity, just as children acquiring Dutch.

Finally, the findings of the present study are in line with the findings of Ketrez (2004a,b,c), which are based on experiments that tested children's comprehension of the accusative marked versus non-case marked objects. In these studies I argued that children did not differentiate case marked from non-case marked indefinite objects. The omission of the accusative case in specific contexts in the present study complements the earlier findings.

Notes

¹Scrambling is possible when the bare object have generic interpretation, which is a kind of a specific interpretation, or when they refer to "an entity or category that has been mentioned (or implied) in the immediately preceding discourse" (Göksel & Kerslake, in press)

²Abbreviations (based on MacWhinney (2000), adapted to Turkish): acc: accusative, dat: dative, gen: genitive, loc: locative, abl: ablative, poss: possessive, ins: instrumental, com: commutative, plu: plural, 1S: first person singular, past: past tense, prog: progressive, plu: plural, Ø: omission, *Ø: ungrammatical omission, CM: common noun, PN: proper noun, PRO: pronoun, QNP: quantifier NP.

³The data analyzed in this study were collected for the project "The Longitudinal Study of the Acquisition of Turkish", which was supported by a grant from the Bogazici University Research Fund. I am grateful to Ayhan Aksu-Koç, the project director, for providing me with the access to the data.

⁴Bever & Slobin (1982) report that the SOV order is the most common word order in both adult and early child speech and in the absence of any morphological evidence children treat the second nominal as the object.

⁵Two generic uses.

⁶The accusative tokens in this table include one-word utterances or utterances that do not contain a verb so that a more efficient comparison can be made with the other cases which do not necessarily occur in utterances that contained a verb. Therefore the number of tokens is not the same as the numbers discussed above or reported in Table-1, which included the utterances that contained both a verb and an object only.

References

- Aksu-Koç, A. and Slobin, D. I. 1985. "The acquisition of Turkish," In Slobin, D.I. (Ed.) *Cross-linguistic Study Language of Language Acquisition*, 1. New Jersey: Lawrence Erlbaum Associates. 839-878.
- Aksu-Koç, A. & Ketrez, F. N. 2003. "Early verbal morphology in Turkish: Emergence of inflections." In D. Bittner, W.U. Dressler & M. Kilani-Schoch (Eds.) *Mini-paradigms and the emergence of verb morphology*. Berlin: M. De Gruyter 27-52.

- Borer, H. & B. Rohrbacher 2003. "Minding the absent," *Language Acquisition*, **10**. 123-176.
- Ekmekçi, O. 1986. "Significance of word order in the acquisition of Turkish," In D. Slobin & K. Zimmer (Eds.) *Studies in Turkish Linguistics*. Amsterdam: John Benjamins. 265-272.
- Enç, M. 1991. "The Semantics of Specificity." *Linguistic Inquiry*, **22**. 1-25.
- Erguvanlı, E. E. (1984) *The Function of Word Order in Turkish Grammar*. Berkeley: University of California Press.
- Göksel, A. & Kerslake, C. in press. *Turkish: A comprehensive grammar*. London: Routledge.
- Gürel, A. 2000. "Missing case inflection: Implications for second language acquisition." In C. Howell, S. A. Fish & T. Keith-Lucas (Eds.). *Proceedings of the 24th Annual Boston University Conference on Language Development*, Somerville, MA: Cascadilla Press, 379-390.
- Haznedar, B. 2004. "Missing surface inflection in adult and child L2 acquisition." In Juana M. Liceras et al. *Proceedings of the 6th Generative Approaches to Second Language Acquisition Conference (GASLA 2002)*. Somerville, MA: Cascadilla Proceedings Project, 140-149.
- Ketrez, F. N. 1999. *Early Verbs and the Acquisition of Turkish Argument Structure*. MThesis, Boğaziçi University, Istanbul.
- Ketrez, F. N. 2004a. "Children's accusative case and indefinite objects." *Dilbilim Araştırmaları 2004*, 63-74.
- Ketrez, F. N. 2004b. "Children's accusative marked indefinites." In Csirmaz, A. Lee, Youngjoo Lee & M. A. Walter (Eds.). *Proceedings of the Workshop on Altaic Formal Linguistics I*. Cambridge, MA: MIT Working Papers in Linguistics, Volume 46. 243-257.
- Ketrez, F. N. 2004c. "Children's scope of indefinite objects and negation." Paper presented at ICTL 2004: 12th International Conference on Turkish Linguistics. Dokuz Eylül University, Izmir, Turkey. August 11-13, 2004
- Ketrez, F. N. & Ayhan Aksu-Koç. 2004. "Early Nominal Morphology: Emergence of Case and Number." Ms. Under Review.
- Kornfilt, J. 1994. "Some remarks on the interaction of case and word order in Turkish: Implications for Acquisition," In Lust, B., Suñer, M. and Whitman, J. (Eds.) *Syntactic Theory and First language Acquisition: Cross-linguistic Perspectives*, **1**: Heads, Projections and Learnability New Jersey: Lawrence Earlbaum Associates. 171-199.
- Kural, M 1992. "Properties of Scrambling in Turkish." Ms., UCLA.
- MacWhinney, B. 2000. *The CHILDES Project*. New Jersey: Lawrence Earlbaum Associates.
- Miyamoto, E.T., K. Wexler, T. Aikawa & S. Miyagava 1999. "Case dropping And Unaccusatives in Japanese Acquisition." *Proceedings of the 23rd Annual Boston University Conference on Language Development*. Cascadilla Press 443-452.
- Otsu, Y. 1994. "Case-marking Particles and Phrase structure in Early Japanese Acquisition." In Lust, B., Suñer, M. & Whitman, J. (eds.) *Syntactic Theory and First language Acquisition: Cross-linguistic Perspectives*. Vol.1: Heads, Projections and Learnability. New Jersey: Lawrence Earlbaum Associates. 159-169.
- Öztürk, B. 2004. *Case, referentiality, and phrase structure*. Unpublished Ph.D. Dissertation. Harvard University.

- Schaeffer, J. 1997. *Direct object scrambling in Dutch and Italian child language*. Ph.D. Thesis.UCLA.
- Schaeffer, J. 2000. *The acquisition of direct object scrambling and clitic placement syntax and pragmatics*. Language Acquisition and Language Disorders. Vol. **22**. Amsterdam Philadelphia: John Benjamins Publishing Company.
- Slobin, D. I. 1985. *Cross-linguistic Study of Language Acquisition*. Vol:1. New Jersey: Lawrence Earlbaum Associates.

Comp-trace Effects are EPP-driven: The Role of Anti-locality

George Kotzoglou
The University of Reading

1. Introduction

This paper examines the **Comp(lementizer)-t(race)** effect, i.e. the asymmetry in (1-3), whereby a subject cannot be extracted from a clause headed by an overt complementizer, but an object and an adjunct can:

- (1) a. *Who did you think [_{CP} that ____ hated Nick]?
- b. Who did you think [_{CP} Ø ____ hated Nick]?
- (2) a. Who did you think [_{CP} that Nick hated ____]?
- b. Who did you think [_{CP} Ø Nick hated ____]?
- (3) a. When did you think [_{CP} that Nick hated Mary ____]?
- b. When did you think [_{CP} Ø Nick hated Mary ____]?

Comp-t effects have received great attention in the literature, but they remain problematic for the theory of locality, as they define a domain in which extraction of an adjunct gives better results than extraction of an argument (subject) (3a vs. 1a). Moreover, they involve an unprecedented asymmetry in extractability [subject vs. non-subject], while the usual case is [object vs. non-object] in non-null subject languages and [argument vs. non-argument] in null subject languages. Finally, they seem to correlate quite interestingly with *pro*-drop (the absence of Comp-trace effects has been one of the defining properties of the *pro*-drop parameter since Perlmutter 1971 and Rizzi 1982).

2. GB Accounts of Comp-trace

Leaving aside the filter approach to Comp-t (Chomsky & Lasnik 1977), most of the GB literature provided ECP accounts (5) for the ungrammaticality of (4).

- (4) *Who did you think [_{CP} t₃ that [_{TP} t₂ hated [_{VP} t₁ Nick]]]?
- (5) The trace (t₂) in [Spec, TP] fails to be...

- i) antecedent-governed, due to the intervention of the overt Comp (rigid minimality) (Lasnik & Saito 1984, Chomsky 1986).
- ii) head-governed, since t_2 cannot agree with the overt Comp and turn it into a proper head governor for t_1 (Relativized Minimality) (Rizzi 1990).

Licit subject extraction in null subject languages is then assumed to take place directly from the VP-internal position (t_3), or even from [Spec, TP] if T-to-C licenses the preverbal position:

- (6) The trace (t_2) in [Spec, TP] fails to be...
 - iii) head-governed by the verb in languages which lack T-to-C (Law 1991).

The core assumption of these works is that in languages which do not exhibit Comp-t effects the subject can move from a governed position (either the base one (Rizzi 1982), or the derived one after T-to-C (Law 1991)).

A first problem¹ for ECP accounts is the resort to government, which has been abandoned in minimalism, as it does not follow from interface considerations.

Secondly, proposals which rely on T-to-C movement as the means of licensing the intermediate trace fail to explain the lack of Comp-t effects in some languages which do not exhibit overt verb movement to C: Spanish and Catalan do not move T to C in interrogatives (Ordóñez 2000), but they do *not* have the Comp-t effect, either. The same applies to Greek, which does not exhibit T-to-C in obligatory inversion contexts (Anagnostopoulou 1994, Kotzoglou 2003, among others), possibly due to the blocking effects of preverbal particles.

A third argument against the ECP analyses of Comp-trace derives from the fact that extraction from the postverbal position might not be the only factor ameliorating Comp-trace effects. Hausa is a *pro*-drop language that bans postverbal subjects but escapes Comp-trace violations (examples from Tuller 1986: 152-154):

- (7) a. Waa_i kikee tsammaanii (wai) t_i yaa tafi Kanoo?
Who 2-sing-fem think that 3-sing-masc go Kano
'Who did you think that went to Kano?'
- b. Waa_i Aabu ta tambayaa koo t_i yaa tafi Kanoo?
Who Aabu 3-sing-fem ask whether 3-sing-masc go Kano
'Who did Abu ask whether went to Kano?'

It seems, therefore, that traditional ECP analyses cannot provide an adequate explanation for Comp-t phenomena. Let us now turn to some minimalist analyses of the Comp-t effect.

3. Recent Analyses

Ishii (2004) argues that Comp-t effects due to the Vacuous Movement Hypothesis (George 1980). *Wh*-subjects do not need to move to [Spec, CP]. So, subordinate interrogative clauses with *wh*-subjects are simple TPs.

(8) [TP who hates Peter]

The TP in (8) is selected by the verb of the superordinate clause and *wh*-movement proceeds without troubles, since the *wh*-element is at the edge (or since there is no CP-phase). When an overt Comp is present, CP is projected, but the *wh*-subject again does not move to [Spec, CP] due to the fact that it can check its features against C by being in its local domain.

(9) [CP that [TP who hates Peter]]

But now *who* is no longer at the edge of the CP-phase. As a consequence, it cannot move further due to the Phase Impenetrability Condition (since *who* is not at the (phonological) edge of CP).

(10) [CP do [TP you think [CP that [TP who hates Peter]]]]

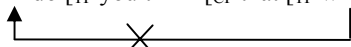

However, Ishii's proposal faces some problems. First of all, if phases are *propositional* (Chomsky 2000), then the embedded clause must be a CP and not a TP². Secondly, this account cannot accommodate the data from Hausa, presented in (7). Preverbal subjects of null subject languages may not occupy [Spec, TP] but are nevertheless hosted in a Spec in the Minimal Domain (in Ishii's terminology) of C. So, their extraction is predicted to give rise to Comp-t effects (if it cannot take place from within *vP*). However no such effects are observed.

According to Pesetsky & Torrego (2001), C bears an uninterpretable Tense feature (*uT*) with EPP properties. This feature can be satisfied either by T-to-C movement or by merger of a nominative subject to [Spec, CP] (due to the authors' assumption that 'Nominative case is *uT* on D' p.361). In other words, an interrogative nominative subject can check both the *uEPP_C* and the *uT* feature on C when merged in [Spec, CP]:

(11) [CP [who_{+wh,uT}] C_{-wh,uT} ...]

Moreover, the presence of the complementizer *that* on C is taken to be a reflex of T-to-C movement. This kind of movement, is blocked in the presence of an interrogative subject which is equally close to C and can check not only *uT* but

also *uWh* on C. So T-to-C movement (and, therefore, the realization of the complementizer *that* in Comp-t clauses) is blocked by economy.

However, if the declarative Comp is a reflex of T-to-C, it is unclear what explains cases where both T and C are realized (or even separated by rich functional structure, as in Greek, with preverbal particles intervening between C and T, see Kotzoglou 2003).

Roussou (2002) pursues an alternative account, according to which the overt Comp blocks T-to-C movement, which is possible then Comp is absent. With *wh*-elements directly inserted in their surface positions (in the spirit of Manzini & Roussou 2000), T-to-C movement is required so that T is brought to the edge of its phase (as in Chomsky 2001) and becomes visible to the *wh*-phrase for feature valuation.

(12) [CP which author do you think [CP C-Agr-T [VP won the prize]]]?
 ↓-----↑

T-to-C movement checks the *uEPP_T* feature (understood, in this context, as a requirement or PF-realization of T), and the relation between the *wh*-phrase and the T-Agr heads (raised to C) contributes the interpretation of Agr.

However, even this approach faces a number of problems. The EPP that is checked by T-to-C in examples like (12) is claimed to be a requirement for PF realization of the feature content of T. It is not evident why PF consideration would drive movement in a case where both the probe (C) and the goal (T) are phonologically null (as in Comp-less clauses). Moreover, it is not evident how the *wh*-phrase can value the features of its corresponding Agr from its derived positions via the operation *Agree*, when a number of phases intervene (as in the case of cyclic *wh*-movement with intervening vPs/CPs).

We conclude that a successful analysis of Comp-t effects should: i. Explain the correlation with *pro*-drop (possibly with subjects moving from their base positions –which is not necessarily postverbal (see 7)). ii. Single out subjects. iii. Build on the idea that the relation between the C head and the subject is relevant to the effect, but without necessarily forcing T-to-C movement.

4. Proposal

The proposal that we will put forth is based partly on Rizzi's (1982) intuition that in successful cases of *wh*-subject extraction (those of *pro*-drop languages) movement does not pass through the canonical EPP position.

(13) chi credi [che [venga t]]?
 who think-2SG that come-SUBJ
 'Who do you think is coming?' (Italian)

Let us suppose, therefore, that an extracted *wh*-phrase can skip its corresponding [Spec, TP] even in non-*pro*-drop languages.³ Leaving aside the reason for the time being, let us examine what this would mean for the Comp-t effect in English:

Suppose that the derivation of (14a) reaches the embedded TP-level:

- (14) a. Who did you think hated Nick?
 b. [TP T_{uEPP}T_{uφ} [vP who_{uCase, iφ, uWh} [hated Nick]]]

T seeks a goal that can check of its uninterpretable φ -features and finds the in-situ *wh*-subject, visible due to its *uCase* feature. Long distance *Agree* is induced which results in valuation of the φ -features of T and the Case feature of *who*. Let us now assume that pied-piping *who* to [Spec, TP] for the elimination of the *uEPP*_T feature does not take place (for reasons to be explained soon).

However, the *uEPP*_T feature cannot remain unchecked within its phase. So, when the next functional head is merged (and that is C, we assume) the *uEPP*_T-feature percolates⁴ up to C (which is already endowed with its own *uEPP*_C feature (P-feature) for attracting A'-elements). Movement of *who* to [Spec, CP] will now check both EPP feature at once and the derivation will converge:

- (15) [CP who_{uCase, iφ, uWh} [C_{uEPPC, uEPP}uWh] [TP T_{uφ} [vP ~~who~~ [hated Nick]]]

Now, the derivation of (16), with the overt Comp

- (16) *Who did you think that hated Nick

would involve a first step similar to the previous one:

- (17) [TP T_{uEPP}T_{uφ} [vP who_{uCase, iφ, uWh} [hated Nick]]]

Let us suppose again that *who* does not raise to [Spec, TP] (so, EPP is not always a direct reflex of Match and Agree). The derivation proceeds as follows:

- (18) *merge* [C that_{uEPPC}] and [TP [T_{uEPP}T] [vP [who_{uWh}] [vP hated Nick]]] ⇒
 [CP [C that_{uEPPC}] [TP [T_{uEPP}T] [vP [who_{uWh}] [vP hated Nick]]]]

spell-out VP (but [who_{uWh}] on the edge of vP remains active)

match [who_{uWh}] and [C that_{uEPPC}], check *uWh* on *who*

move [who] to Spec of [CP that [TP [T_{uEPP}T] [vP [vP hated Nick]]]] ⇒
 [CP who [C' [that_{uEPPC}] [TP [T_{uEPP}T] [vP ~~who~~ [vP hated Nick]]]]]

check $uEPP_C$ feature against the moved DP \Leftrightarrow
 [CP who [C' [that _{$uEPP_C$}] [TP [T * $uEPP_T$] [_{VP} who [_{VP} hated Nick]]]]]]

The presence of the overt complementizer blocks EPP-feature percolation from T to C, and therefore the $uEPP_T$ ⁵ remains on T in (18) and the CP-phase crashes.

The question that arises now is what blocks the derivation according to which the subject passes through the ‘canonical’ [Spec, TP] position. Several answers have been proposed in the recent literature: Rizzi (2004) argues that the subject position is a ‘criterial (freezing) position’, corresponding to a peripheral semantic interpretation. Chomsky (2004) claims that chain uniformity forces the subject to move to an A’-position without passing through an A-position.

Let us take an alternative route and capitalize on the fact that [Spec, TP] is a position which accommodates a moved element without being a phase-edge position in Chomsky’s (2000, 2001) system. Any moved argument that passes through this Spec on its way to [Spec, CP] will therefore end up with three copies active (non-spelled-out) in the CP-phase, the copies being the one in [Spec, vP], the one in [Spec, TP] and the one in [Spec, CP].

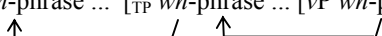
(19) *_{[CP wh-phrase ... [TP wh-phrase ... [vP wh-phrase ...]]}

Two of these copies must be phonologically silenced. PF-deletion of unpronounced occurrences of a moved constituent (copies) has been termed ‘Chain reduction’ in work by Nunes (1999, 2004):

(20) **Chain reduction** (Nunes 2004: 27)
 Delete the minimal number of constituents of a nontrivial chain CH that suffices for CH to be mapped into a linear order in accordance with the LCA.

Nunes proposal predicts that all but one copy in a movement chain will be deleted at PF to ensure convergence (linearization according to Kayne’s LCA).

But, movement may also not be too local (Grohman 2000). Given the postulated existence of three *prolific domains* (θ -domain (vP), φ -domain (IP) and ω -domain (CP)), Grohmann claims that the following condition holds, which prohibits movement within these domains:

(21) **Condition on Domain Exclusivity (CDE)** (Grohmann 2000:23)
 An object O in a phrase marker must have an exclusive Address Identification per Prolific Domain $\Pi\Delta$, unless duplicity yields a drastic effect on the output.
 i. An AI of O in a given $\Pi\Delta$ is an occurrence of O in that $\Pi\Delta$ at LF.
 ii. A drastic effect on the output is a different realization of O at PF.

Let us now suppose that the anti-locality condition holds, but it does not apply to prolific domains but to phases. Then we suggest that chain reduction cannot delete two copies of a moved element within a single phase:

(22) **Revised chain reduction axiom**

Chain reduction (deletion of the phonetic content of the lower parts of a chain) can apply to at most one pair of occurrences of an element in each phase.

This would force movement to target the edge of phases in order to proceed further up, and it would also render all non-edge target positions ‘criterial positions’ in Rizzi’s (2004) terminology, that is positions that -when reached by a moving element- disallow further movement.

However, contra Rizzi, (22) predicts that an element base-generated in a criterial position will be able to move upwards, as we will see in the case of CLLDed subjects of *pro*-drop languages (and as is the case in (7) from Hausa).

Let us return to a potentially problematic aspect of the current analysis. Consider the point in the derivation of (14b) where Agree between T and the in-situ *wh*-subject has been established:

(23) $[_{TP} T_{uEPPT\#} [_{VP} \text{who}_{uCase, i\phi, uwh} [\text{hated Nick}]]]$

The question that arises is why is merge to [Spec, TP] banned in subject extraction contexts, although the subject and T agree, and although T has an EPP_T feature to discharge.

The obvious answer would be that such a movement would prevent further movement of the subject due to our (22) [or Rizzi’s (2004) *criterial freezing*, or Chomsky’s (2004) *chain uniformity*]. However, in a locally economic system, such as that argued for in Collins (1997), Frampton & Gutmann (2002) look-ahead is banned. However, if we assume with Chomsky (2001) that derivations are evaluated at the phase-level, we can permit a small look-ahead in the relevant cases forced by the need for convergence. In other words, we assume that (i) phase-internal comparison of alternative derivations is permitted, and (ii) strict local economy is observed only when it leads to convergent derivations. So, at the CP level the alternative derivations (with and without subject movement to [Spec, TP]) would be:

(24) a. $[_{CP} \text{who}_{i\phi, uwh} [_{TP} T_{uEPPT\#} [_{VP} \text{who}_{\#Case, i\phi, uwh} [\text{hated Nick}]]]]$
 b. $*[_{CP} \text{who}_{i\phi, uwh} [_{TP} \text{who}_{i\phi, uwh} T_{uEPPT\#} [_{VP} \text{who}_{\#Case, i\phi, uwh} [\text{hated Nick}]]]]$

(24b) observes local economy, but crashes due to (22). So, at the phase-level (24a) wins over (24b).

Note that local economy can be ignored only in cases where it leads to non-convergent outputs. In all other cases locally economic derivations are to be preferred:

- (25) a. * $[_{XP}$ without a doubt $[_{TP}$ will $[_{vP}$ Maria [like apples]]]
 b. $[_{XP}$ without a doubt $[_{TP}$ Maria will $[_{vP}$ Maria [like apples]]]

At the TP level Merger of the subject to [Spec, TP] is the locally economic option and wins over EPP-feature percolation to X.

5. Consequences of the Analysis

5.1. The null subject parameter

Null subject languages are exempt from the Comp-t effect (Perlmutter 1971):

- (26) pjos nomizis $[_{CP}$ **oti** elise to provlima]?
 who-nom think-2sg **that** solved-3sg the problem-acc
 ‘Who do you think solved the problem?’ (Greek)

It has been claimed in the literature that preverbal subjects in *pro*-drop languages do not occupy the [Spec, TP] position but are left-dislocated elements⁶. It has also been argued (McCloskey 1996)⁷ that the EPP requirement on T might be altogether suspended in (some) null subject languages. If any of these alternatives is true, then the Comp-t effect, being an EPP-requirement, is correctly predicted to be absent in null-subject languages. Therefore, subject extraction in null subject languages can take place directly from the *vP*-internal position without passing through [Spec, TP]:

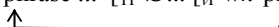
- (27) $[_{CP}$ *wh*-phrase ... $[_{TP}$ \emptyset ... $[_{vP}$ *wh*-phrase ...]]
- 

Notice that the formulation of chain reduction (22) provided above, coupled with the observation that preverbal subjects are CLLDed elements in null subject languages explain why preverbal subjects may also freely extract in these languages (cf. (7)). Since CLLDed are base generated in their surface position in the left periphery (according to Cinque 1990), movement to [Spec, CP] creates a single two-membered chain which does not violate (22):

- (28) $[_{CP}$ *wh*-phrase ... [... *wh*-phrase $[_{TP}$ \emptyset ... $[_{vP}$ *pro* ...]]]
- 

This explanation covers the grammaticality of subject extraction in Hausa (7).

5.2. The adverb effect

According to Culicover (1992), Comp-t effects are ameliorated if adverbial material intervenes between the Comp and the trace of the extracted material:

- (29) a. *Who did you say [that ___ would hate the soup]?
 b. Who did you say [that without a doubt ___ would hate the soup]?

We suppose, then, that left peripheral adverbial material is introduced in the specifier of some projection that intervenes between CP and TP (let us call it XP for present purposes, but it could well be a TopP or FocP). Now, in subject extraction with intervening adverbials, the unchecked EPP-feature on T does not percolate up to C, but up to the X head, where it is checked by the merged adverbial phrase:

- (30) [CP who [C' that_{uEPPC} [XP without a doubt [X' X_{uEPP} [TP [T' T_[] [VP t]]]]]]
-

Direct Merge of the adverbial material to [Spec, TP] is prohibited since it is not driven by the need of feature-checking against T in the first place (we assume that, although potentially dissociated from the operation Agree, EPP-feature satisfaction cannot drive merger in itself). Similarly, the adverbial material cannot function as an expletive simple in declaratives:

- (31) *[Without a doubt] hates Mary the soup

First of all, [without a doubt] cannot be merged in [Spec, TP] because it does not enter any checking relation with it⁸. Secondly, it cannot check the $uEPP_T$ at the XP-level, because this will have been checked in the TP-level by movement of the subject to [Spec, TP].

5.3. The “que-qui” alternation

French bans subject extraction with regular complementizer ‘que’, but allows it with ‘qui’:

- (32) a. *L’homme que tu crois que ___ viendra nous rendre visite...
 The man that you believe that will come pay us a visit...
 b. *L’homme que tu crois qui ___ viendra nous rendre visite...

The observation that the complementizer ‘qui’ appears only in sentences with extracted subjects has led to the conclusion that it is an ‘agreeing’ Comp (cf. Rizzi 1990). In our system this would mean that it allows feature percolation from T, or even actual T-to-C movement.

An alternative explanation, equally compatible with the proposal advanced here, is that the “agreeing” complementizer ‘qui’ in French is actually the sequence of the complementizer ‘que’ followed by the subject clitic ‘i’, as proposed by Taraldsen (2002). If this is so, then the subject clitic checks the (potentially offending) EPPT-feature and explains the absence of Comp-t effects in extraction from *qui*-clauses.

6. Conclusions

We have proposed that the Comp-t effect is due to an EPP_T -feature violation. More specifically, an extracted *wh*-subject may not pass through its [Spec, TP] due to the Revised chain reduction axiom, banning phase-internal movement. Moreover, the presence of an overt complementizer in C blocks T-to-C feature percolation. As a consequence the $uEPP_T$ -feature fails to be checked in non null subject languages.

The proposed analysis explains the absence of Comp-t effects in *pro*-drop languages, even if these languages do not manifest movement from the postverbal position (Hausa) or T-to-C head movement (Greek).

Notes

¹ Of course, a pioneering argument against ECP accounts of Comp-t was offered in Culicover’s (1992) work on the *adverb effect*.

² Exactly the same problem arises if phases are defined by φ -completeness. Note, also, that by assuming that embedded indirect questions may be TPs a potential problem of clause typing arises. In other words, it is not clear what ensures that [TP who hates Peter] will be interpreted as a declarative in the context of ‘Did you say ___’, but as an interrogative in the context of ‘I wonder ___’.

³ Cf. Taraldsen (2002), Holmberg & Hróarsdóttir (2003), Chomsky (2004) and Rizzi (2004) for similar proposals.

⁴ The postulation of a feature percolation mechanism here, although novel and stipulative, nevertheless follows familiar intuitions on the close relation between the left peripheral heads (including T), cf. Grimshaw’s (1991) *extended projection*, or Neeleman & van de Koot’s (2002) *accessibility*, or Rizzi’s (1997) left-periphery. (Cf. also Chomsky’s (2004) suggestion that phase heads “might involve feature spread from ... functional categories”.)

⁵ It is evident that the EPP_T -feature assumed here is not that of Chomsky (2000, 2001), since its checking is not a direct reflex of *Agree*. Let us suppose that the EPP-feature is just the requirement that overt material fills the Spec of a head (cf. Holmberg 2000).

⁶ See Philippaki-Warbuton (1987), Barbosa (1995), Alexiadou and Anagnostopoulou (1998), and also Spyropoulos & Philippaki-Warbuton (2001) for Greek. These works assume that EPP-checking takes place by means of a *pro* or subject clitic, or by head movement to T.

⁷ See Kotzoglou (2001) for Greek.

⁸ For the claim that even expletives participate in feature checking with T see Chomsky (2001).

References

- Alexiadou, Artemis, and Elena Anagnostopoulou. 1998. ‘Parametrizing AGR: word order, V-movement and EPP-checking’, *Natural Language and Linguistic Theory*, **16**: 3: 491-539.
- Anagnostopoulou, Elena. 1994. *Clitic dependencies in Modern Greek*. Doctoral

- dissertation, University of Salzburg.
- Barbosa, Pilar. 1995. *Null subjects*. Doctoral Dissertation, Massachusetts Institute of Technology.
- Chomsky, Noam. 1986. *Barriers*. Cambridge, MA: MIT Press.
- Chomsky, Noam. 2000. 'Minimalist inquiries: the framework', in Roger Martin, David Michaels, and Juan Uriagereka (eds.) *Step by step: essays on minimalist syntax in honor of Howard Lasnik*. Cambridge, MA: MIT Press. 89-155.
- Chomsky, Noam. 2001. 'Derivation by phase', in Michael Kenstowicz (ed.) *Ken Hale: a life in language*. Cambridge, MA: MIT Press. 1-52.
- Chomsky, Noam (2004) 'On phases', paper presented at GLOW 27, Thessaloniki.
- Chomsky, Noam, and Howard Lasnik. 1977. 'Filters and control.' *Linguistic Inquiry*, **8**: 425-405.
- Cinque, Guglielmo. 1990. *Types of A'-dependencies*. Cambridge, MA: MIT Press.
- Collins, Chris. 1997. *Local economy*. Cambridge, MA: MIT Press.
- Culicover, Peter. 1992. 'The adverb effect: evidence against ECP accounts of the that-t filter', *Proceedings of NELS 23*: 97-111.
- Frampton, John, and Sam Gutmann. 2002. 'Crash-proof syntax', in Samuel David Epstein, and Daniel T. Seely (eds.) *Derivation and explanation in the minimalist program*. Oxford: Blackwell Publishing. 90-105.
- George, Leland M. 1980. *Analogical generalization in natural language syntax*. Doctoral dissertation, Massachusetts Institute of Technology.
- Grimshaw, Jane. 1991. *Extended Projection*. Ms, Brandeis University.
- Grohmann, Kleanthes K. 2000. *Prolific peripheries: a radical view from the left*. Doctoral dissertation, University of Maryland at College Park.
- Holmberg, Anders. 2000. 'Scandinavian stylistic fronting: how any category can become an expletive', *Linguistic Inquiry*, **31.3**: 445-483.
- Holmberg, Anders, and Thorbjörg Hróarsdóttir. 2003. 'Agreement and movement in Icelandic raising constructions', *Lingua*, **113**: 997-1019.
- Ishii, Toru. 2004. 'The phase impenetrability condition, the vacuous movement hypothesis, and that-t effects', *Lingua*, **114.2**: 183-215.
- Kotzoglou, George. 2001. 'First notes on Greek subjects', *Reading Working Papers in Linguistics*, **5**: 175-199.
- Kotzoglou, George. 2003. 'Obligatory inversion and the status of head movement: evidence from Greek', *Reading Working Papers in Linguistics* **7**: 19-52.
- Lasnik, Howard, and Mamoru Saito. 1984. 'On the nature of proper government', *Linguistic Inquiry* **15**: 235-289.
- Law, Paul S. (1991). *Effects of head-movement on theories of subjacency and proper government*. Doctoral dissertation, Massachusetts Institute of Technology.
- Manzini, Maria Rita, and Anna Roussou. 2000. 'A minimalist theory of A-movement and control', *Lingua*, **110**: 409-447.
- McCloskey, James. 1996. 'Subjects and subject positions in Irish', in Robert D. Borsley, and Ian Roberts (eds.) *The syntax of the Celtic languages: a comparative perspective*. Cambridge: Cambridge University Press. 241-283.
- Neeleman, Ad, and Hans van de Koot. 2002. 'The configurational matrix', *Linguistic Inquiry* **33**: 529-574.
- Nunes, Jairo. 1999. 'Linearization of chains and phonetic realization of chain links', in Samuel David Epstein, and Norbert Hornstein (eds.) *Working minimalism*. Cambridge,

- MA: MIT Press. 217-249.
- Nunes, Jairo. 2004. *Linearization of chains and sideward movement*. Cambridge, MA: MIT Press.
- Ordóñez, Francisco. 2000. *The clausal structure of Spanish: a comparative approach*. New York: Garland Publishing
- Perlmutter, David M. 1971. *Deep and surface structure constraints in syntax*. New York: Holt, Reinhart & Winston.
- Pesetsky, David, and Esther Torrego. 2001. 'T-to-C movement: causes and consequences', in Michael Kenstowicz (ed.) *Ken Hale: a life in language*. Cambridge, MA: MIT Press. 355-426.
- Philippaki-Warbuton, Irene. 1987. 'The theory of empty categories and the pro-drop parameter in Modern Greek', *Journal of Linguistics*, **23**: 289-318.
- Rizzi, Luigi. 1982. *Issues in Italian syntax*. Dordrecht: Foris Publications.
- Rizzi, Luigi. 1990. *Relativized minimality*. Cambridge, MA: MIT Press.
- Rizzi, Luigi. 1997. 'The fine structure of the left periphery', in Liliane Haegeman (ed.) *Elements of grammar: handbook of generative syntax*. Dordrecht: Kluwer Academic Publishers. 281-337.
- Rizzi, Luigi. 2004. *On the form of chains: criterial positions and ECP effects*. Ms. University of Siena.
- Roussou, Anna. 2002. 'C, T, and the subject: that-t phenomena revisited', *Lingua*, **112**: 13-52.
- Spyropoulos, Vassilios, and Irene Philippaki-Warbuton. 2001. "'Subject' and EPP in Greek: the discontinuous subject hypothesis", *Journal of Greek Linguistics*, **2**: 149-186.
- Taraldsen, Knut Tarald. 2002. 'The *que/qui* alternation and the distribution of expletives', in Peter Svenonius (ed.) *Subjects, expletives, and the EPP*. Oxford: Oxford University Press. 29-42.
- Tuller, Laurie. 1986. *Bijjective principles in universal grammar and the syntax of Hausa*. Doctoral dissertation, UCLA.

George Kotzoglou
 School of Linguistics
 & Applied Language Studies
 The University of Reading
 United Kingdom
 kotzoglou@gmail.com

A Semantic and Syntactic Analysis of Vietnamese Causatives

Nayoung Kwon
UC-San Diego

1. Introduction¹

The causative construction is a structure with a complex predicate denoting the event of causation and the desired event brought about by the causer. If a language has an alternation between an analytical causative and a synthetic (morphological) causative, the former is predicted to denote indirect causation, and the latter, direct causation (Comrie 1989). Less is known about the variation in properties of analytical causatives in those languages which simply lack the morphological version—as in isolating languages, for example. In this paper, I present a semantic and syntactic analysis of the Vietnamese causative construction *làm (cho)* ‘make’ as in (1), showing that this causative construction has both indirect and direct causation interpretations and both bi- and monoclausal properties. Following Duffield’s (1999) analysis of Vietnamese clause structure, I provide the syntactic analysis of the complement clause of the construction. The proposed structure of the construction, in turn, provides the means to evaluate the analysis of sentence-final modal-like elements by Duffield (1999).

- (1) Tôi làm cho con chim bay
1sg make CL bird fly
‘I made a bird fly’

The paper is structured as follows. Section 2 introduces basics of Vietnamese grammar and analyzes the semantics of the *làm (cho)* construction. Section 3 presents syntactic properties of the construction. Section 4 introduces the IP structure proposed by Duffield (1999), and proposes a syntactic analysis of the *làm (cho)* construction. Section 5 discusses the IP structure and analyses of the modal elements by Duffield in detail using the *làm (cho)* construction, and suggests revision. Section 7 summarizes the findings.

2. Typological and Semantic Analyses

Vietnamese, which belongs to the Mon-Khmer language family, has three main dialects. The current study is based on the Northern dialect. It has isolating morphology, tone, SVO word order, and is head-initial. Moreover, as can be seen throughout the examples in the paper, tense marking is optional. This section examines semantics of the Vietnamese causative construction, *làm (cho)*.

2.1 Analytical causative

The *làm (cho)* construction shows characteristics of analytical causatives. The construction has separate predicates for expressing the notions of causation and effect. Moreover, the argument structures of the causation predicate and the lower verb are maintained, as shown in (2) and (3).

- (2) đá tan
ice melt
'Ice melt'
- (3) Tôi làm đá tan
Isg make ice melt
'I made ice melt.'

Typologically, there are close mappings between analytical and indirect causatives, and between morphological and direct causatives. As an isolating language, Vietnamese lacks a morphological causative. A question arises whether the *làm (cho)* construction is limited to the expression of indirect causation. This question is discussed in detail in the next section.

2.2 Direct/Indirect causative

Even though the *làm (cho)* construction is an analytical causative, the construction can express both direct and indirect causation, depending on the degree of control on the part of the causee. When the causee is inanimate, the construction always expresses direct causation. In (4), the indication that the causation is direct comes from the fact that the caused event is entailed and cannot be cancelled. However, when the causee is animate (5), the construction preferentially expresses indirect causation. In particular, the cancellation of the effect does not lead to contradiction.

- (4) #Tôi làm (cho) cây ngã nhưng nó không ngã
I make tree fall but it not fall
'I made a tree fall but it did not fall.'
- (5) Tôi làm (cho) chó sủa, nhưng nó không sủa tiếng sủa gì cả
I make dog bark but it not bark sound at all
'I made the dog bark but it did not bark at all.'

Thus, the interpretation of the Vietnamese causative construction is ambiguous between direct and indirect causation. The choice of the interpretation crucially depends on the degree of control on the part of the causee. In the next section, I turn to the syntactic analysis of the construction.

3. Syntactic Analysis of Vietnamese Causative Construction

The goal of this section is to present the syntactic features of the *làm (cho)* construction. Typologically, analytical causatives tend to be associated with biclausal structure; indirect causation is a typical correlate of biclausality, while direct causation often corresponds to a monoclausal structure. However, as shown in the previous section, analytical causatives in Vietnamese could denote direct as well as indirect causation. This leads to two questions: (i) is the *làm (cho)* construction structurally ambiguous (monoclausal vs. biclausal), and (ii) if the construction is structurally ambiguous, is there a one-to-one correspondence between clausality and directness of causation? In this section, I show that the Vietnamese causative construction does show such structural ambiguity between bi- and monoclausality.

3.1 Biclausal properties

A biclausal analysis of the *làm (cho)* construction is based on adverbial placement, scope of negation, and the use of a sentential proform.

3.1.1. Adverbial placement

The *làm (cho)* construction can host two separate adverbials associated with causation and effect events, respectively. Sentence (6) shows this event modification with two temporal adverbials.

- (6) Hôm qua Minh làm cho Mary đi vào tiệm ngày hôm nay
 yesterday Minh make Mary go into store today
 'Yesterday Minh made Mary go into a store today.'

The example of adverbial modification supports the biclausal analysis of *làm (cho)* construction.

3.1.2. Scope of negation

The *làm (cho)* construction can have the negation marker *không* appearing before either the causation predicate, or the effect predicate, leading to different interpretations. Sentence (7) shows the negation of the causation predicate and (8) shows the negation of the effect predicate.

- (7) Tôi không làm đá tan
 I not make ice melt
 'I did not make the ice melt.'
- (8) Tôi làm đá không tan
 I make ice not melt
 'I prevented the ice from letting (lit.: I made the ice not melt).'

Evidence on the scope of negation also supports a biclausal analysis of the construction.

3.1.3. *Làm như vậy proform*

In the *làm (cho)* construction, *làm như vậy* ‘do so’ can replace the causation predicate as in (9) or the effect predicate as in (10).

- (9) John làm cho Mary giết Sam và tôi đã ngạc nhiên vì anh ta làm như vậy
 John make Mary kill Sam and I pst surprise that he did so
 ‘John makes Mary kill Sam and it surprised me that he did so.’
- (10) John làm cho Mary giết Sam và tôi đã ngạc nhiên vì cô ta làm như vậy
 John make Mary kill Sam and I pst surprise that she did so
 ‘John makes Mary kill Sam and it surprised me that she did so.’

In sum, adverbial placement, scope of negation and the use of a sentential proform all support a biclausal analysis of *làm (cho)* construction. However, there is also evidence supporting a monoclausal analysis of the construction.

3.2 Monoclausal properties

The arguments for the monoclausality of the *làm (cho)* construction come from negative polarity item licensing, the scope of *được* ‘can, manage to, be permitted to’, and binding.

3.2.1 Negative Polarity Items (NPI): *gì cả* ‘at all’

The distribution of NPIs supports a monoclausal analysis of the *làm (cho)* construction. In general, negative polarity items are licensed by clause-mate negation, as is the case in (11). In addition, the NPI *gì cả* is restricted to sentence-final position, as shown in (12).

- (11) Tôi *(không) đọc sách gì cả
 I not read book at all
 ‘I don’t read the book at all.’
- (12) *Cô ấy không bảo gì cả tôi đọc sách
 she not tell at all I read book
 ‘She does not tell me to read book at all.’

Therefore, when *gì cả* appears in a clear biclausal structure, negation should appear in the lower clause as well, as in (13). When negation appears in the main clause, the sentence is not grammatical, as in (14). *Gì cả* cannot appear before *rằng* ‘that’ either, because it would not be in the sentence-final position, as in (15).

- (13) Cô ấy nói chúng nó [rằng tôi không đọc sách gì cả]
 she say they that I not read book at all
 ‘She tells them that I don’t read the book at all.’
- (14) *Cô ấy không nói chúng nó [rằng tôi đọc sách gì cả]
 she not say they that I read book at all
 ‘She did not tell them that I read the book at all.’

- (15) *Cô ấy không nói chúng nó gì cả [rằng tôi đọc sách]
 she not say they at all that I read book
 ‘She did not tell them that I read the book at all.’

Interestingly, in the *làm (cho)* construction, *gì cả* can be licensed by negation both in the upper and the lower clauses, as sentences (16) and (17) show.

- (16) Tôi làm cho cô ấy không đọc sách gì cả
 I make she not read book at all
 ‘I make her not read books at all.’
 (17) Tôi không làm cho cô ấy đọc sách gì cả
 I not make she read book at all
 ‘I did not make her read the book at all.’

The distribution of NPIs suggests that the causative is monoclausal.

3.2.2 Scope of *được*

Được has different interpretations depending on where it occurs, namely ‘can, manage, be permitted to’². The interpretation most relevant to the current study is when *được* appears sentence-finally as ‘can’.

- (18) Tôi kiếm việc được
 I look-for work aux
 ‘I can look for work.’ (Duffield 1998, p99)

When *được* appears sentence-finally in a clear biclausal structure, its scope is limited to the embedded clause. Therefore, the interpretation of the main predicate is not affected by *được*, as (19) shows.

- (19) John nói rằng Mary đi học được
 John say that Mary go study can
 ‘John said that Mary can go to school.’
 *‘John can say that Mary go to school.’

In the *làm (cho)* construction, however, *được* affects the interpretation of the causation predicate, as shown by (20).

- (20) John làm cho Mary đi học được
 John make Mary go study can
 ‘John can make Mary go to school.’
 *‘John makes Mary able to go to school.’

The scope of *được* suggests that the causative is monoclausal.

3.2.3 Binding: *nhau* ‘each other’

Following standard principles of Binding Theory, we expect the anaphor *nhau* ‘each other’ to be bound in its governing category³. In a clear biclausal structure, *nhau* should be bound within the lower clause, as in (21). If the binder appears in the main clause, with *nhau* in the embedded clause, then the sentence is ungrammatical, as in (22).

- (21) Jane nói rằng chúng nó nhìn thấy nhau
 Jane say that they see each other
 ‘Jane said that they saw each other.’
- (22) *Chúng nó nói rằng nhau đã thắng
 they say that each other past win
 ‘They said that each other won.’

However, in the *làm (cho)* construction the governing category of *nhau* is the whole clause. Therefore, both the causee and the causer can be the binder of *nhau* as (23) and (24) show.

- (23) Tôi làm cho chúng nó nhìn thấy nhau
 I make they see each other
 ‘I made them see each other.’
- (24) Chúng nó làm cho nhau thắng
 they make each other win
 ‘They make each other win.’

In sum, NPI licensing, the distribution of *được* and reflexive binding all support a monoclausal analysis of the *làm (cho)* construction. On the other hand, adverbial placement, scope of negation, and sentential proform tests support a biclausal analysis of this construction.

It remains to be seen if the structural ambiguity corresponds to the difference between direct and indirect causation. The preliminary data collected here do not support such a one-to-one mapping.

In the next section, I examine the syntactic structure of the complement clause of the *làm (cho)* construction, following Duffield’s (1999) analysis of Vietnamese clause structure.

4. Generalized IP Structure and the Causative Construction

4.1 Generalized IP structure of Vietnamese

Examining various syntactic phenomena, Duffield (1998, 1999) proposes the following IP structure for Vietnamese.

(25) topicalized XPs > Subject > Tense > Negation/Assertion > Verb
(Duffield 1999, p100)

Following Cinque (1998), Duffield (1999) argues that Vietnamese modals occupy different syntactic positions with different interpretations.

(26) epistemic modals > tense > deontic > alethic modals > aspectuals > VP
(Duffield 1999, p123)

Identified modal elements include both *có thể* and *được* as epistemic or alethic modals depending on their distribution, and *phải* ‘must’ as a deontic modal.

Let us now check how the proposed clause structure applies to the *làm (cho)* construction.

4.2 Applying IP structure (Duffield 1999) to the causative construction

On the assumption that the causative construction is biclausal, at least in some of its properties, a question arises concerning the level at which the complement clause of the *làm (cho)* construction is projected. As shown in (8), and repeated below, the negation marker *không* can appear in the lower clause, showing that the NegP is projected in that clause.

(27) Tôi làm đá không tan
I make ice not melt
‘I made the ice not melt.’

Moreover, modal elements can also appear in the lower clause as in (28), showing the ModalP projection in the lower clause.

(28) Tôi làm (cho) con của tôi có thể/phải ngừng khóc
I make child of I can/must stop cry
‘I make my child stop crying.’

However, of all the possible tense markers only *sẽ* (future) is partially allowed in the complement clause, as in (29)⁴.

(29) Tôi làm cho Jane ?sẽ/*đang/*đã đọc sách
I make Jane fut/prog /past read book
‘I make Jane read a book.’

Although further study is necessary, it is possible that *sẽ* is not a tense marker, but a modal. It was shown that the complement clause of the *làm (cho)* construction is projected to ModalP. Therefore, if *sẽ* is actually a modal, this is compatible with the current analysis.

Likewise, topicalization, *còn...thì*, is not allowed in the lower clause, as in (30). The ungrammatical sentence (30) contrasts with a clear biclausal sentence (31), where topicalization in the lower clause does not induce ungrammaticality.

- (30) *Tôi làm cho còn Jane thì, cô ấy đọc sách
 I make TP Jane TP she read book
 ('As for Jane, I make Jane read book.')
- (31) Tôi nói rằng còn Jane thì, cô ấy đọc sách
 I say that TP Jane TP she read book
 'As for Jane, I said that she reads books.'

Unlike a clear biclausal sentence, the complement clause of the *làm (cho)* construction is projected up to ModalP, but it does not have a TP or CP. It therefore represents a reduced structure, commonly observed in complement clauses, especially complements of modals or control verbs.

(32) Proposed structure of the complement clause of the *làm (cho)* construction

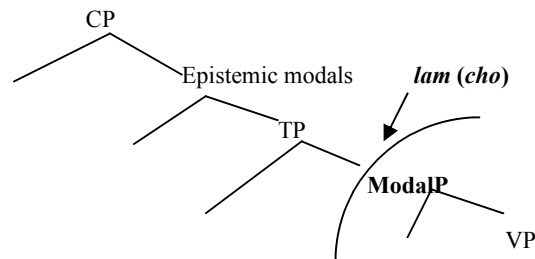

This section showed that the complement clause of the *làm (cho)* construction is projected to the ModalP following the IP structure given by Duffield (1999). Next, based on this finding I revisit the biclausal properties identified in section 3.1.

5. Revisiting Bi- and Monoclausal Properties

Section 3 showed bi- and monoclausal properties of the *làm (cho)* construction. First, biclausal properties were identified using the distribution of negation, adverbial placement and proform tests. The question to follow regarding negation is whether *không* negation is sentential or constituent. Sentences (33) through (35) show that *không* can appear before both the VP and modal, suggesting that *không* is constituent negation.

- (33) Cô ấy sẽ **không** phải gặp em được.
 prn fut neg must meet prn can
 ‘She will not have to meet with you.’
- (34) Cô ấy sẽ phải **không** gặp em được.
 prn fut must neg meet prn can
 ‘She will have to not meet with you.’ (Duffield 1999, p97)
- (35) John kiếm việc **không** được.
 John search job neg can
 ‘John could not find a job.’

Thus, negation phenomena do not pose a problem for the proposed structure of the previous section.

The other two biclausal properties are adverbial placement, as in (6), and the *làm như vậy* sentential proform, as in (9) and (10). These tests, however, are sensitive to the propositional content (semantics) of the VP. Therefore, the two adverbials are licensed semantically rather than syntactically. Likewise, *làm như vậy* might be VP proform.

The evidence in favor of a monoclausal analysis of the *làm (cho)* construction, such as NPI licensing, reflexive binding, and the scope of *được*, could result from the absence of a TP or CP in the complement clause.

Next, based on the proposed structure of the complement clause of the *làm (cho)* construction, I examine the validity of the AssertionP (AsrP), and analyses of *được* and *không* (Duffield 1999).

6. Evaluation of Vietnamese IP structure (Duffield 1999)

One of the most interesting problems that Vietnamese poses for contemporary syntactic theories is the presence of sentence-final modal-like elements in an otherwise predominantly head-initial language. Sentence (36) shows that *được* appears sentence-finally, and its meaning overlaps with that of the alethic modal, *có thể*.

- (36) Tôi (có thể) lái xe được
 I can drive car can
 ‘I can drive a car.’

Trying to account for the aberrant distribution of *được*, Duffield notes the similar pattern for the negation marker *không*. When *không* appears sentence-finally with optional *có*, as in (37), it no longer signals negation. Instead, *không* serves as a question-marker in Yes/No questions.

- (37) Hôm qua anh (có) đến nhà chị không?
 Yesterday he Q go house you Q
 ‘Did he go to your house yesterday?’

In proposing a unified account of these sentence-final modal-like elements in an apparently head-initial language, Duffield suggests an analysis that relies on the interaction of formal (syntactic) and functional (parsing) principles, but without syntactic movement. The only syntactic requirement that is proposed is c-commanding relations. In other words, *được* and *không* are proposed to be licensed by c-commanding heads—*có thể* and *có* respectively. In the next section, I examine this proposal in detail, and show that it calls for revision⁵.

6.1 *Có*: Examining the validity of Neg/AsrP (AssertionP) (Duffield 1999)

Duffield (1999) proposes that *có* heads the Neg/AsrP. The motivation for Neg/AsrP comes from the theory-internal evidence for the Assertion Phrase (Chomsky 1965, Klima 1964), and the language-specific fact that the interpretation of *có* is functionally determined; *có* is interpreted as an emphatic marker in declarative sentences, but as a question marker in interrogative sentences, as in (38) and (37).

- (38) Hôm qua anh **không** (**có**) đến nhà chị.
 Yesterday he neg asr go house you
 ‘He didn’t go to your house yesterday.’
 AssertionP

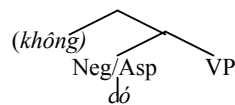

Moreover it was proposed that [\pm wh] features on the AsrP license the sentence-final *không* through c-command. What remains unclear, however, is whether *có* functioning as a question marker really occupies the same syntactic position as *có* functioning as an emphatic marker, as Duffield assumes. In fact, a closer examination of their distribution suggests that they occur in different syntactic positions.

In the preceding sections, I showed that the complement clause of the *làm (cho)* construction is projected up to the ModalP. More specifically, it was shown that negation can appear within the complement clause. This predicts that *có* as an emphatic, and *có* as a question marker should be equally able to appear within the complement clause of the *làm (cho)* construction. But this prediction is not borne out. Only the emphatic use of *có* is possible within the complement clause, as sentences (39) and (40) show.

- (39) ?Minh làm cho cô Lan có ăn hối-lô
 Minh make Miss Lan emp eat bribe
 ‘Minh made Miss Lan did take bribes.’
 (40) *Minh làm cho cô Lan có ăn hối-lô không?
 Minh make Miss Lan int eat bribe Q
 ‘Did Minh make Miss Lan take bribes?’

Sentence (40) contrasts with sentence (41), where the *wh*-word can appear within the complement clause. In other words, sentence (40) is not ungrammatical because of question formation within the complement clause. The sentence is ungrammatical because the complement clause is not projected up to the syntactic position where interrogative *có* occurs, contrary to the Neg/AsrP analysis.

- (41) Minh làm cho John viết cái gì vậy?
 Minh make John write what
 'What did Minh make John write?'

Moreover, there is clear evidence that interrogative *có* appears above TP.

- (42) Minh có đã nói rằng cô Lan thẹn không?
 Minh int past say that Miss Lan shy Q?
 'Did Minh say that Miss Lan was shy?'

In short, interrogative *có* appears in a different syntactic position than emphatic *có*. Therefore, the argument that [$\pm wh$] features on the AsrP licenses the sentence-final *không* through c-command cannot be maintained.

Moreover, a closer examination of empirical data shows that positing the AsrP in Vietnamese is not well motivated (contra Duffield). If the emphatic *có* occurs in the Neg/AsrP as Duffield suggests, both the negation marker *không*, and *có* should be able to co-occur with modals. This prediction, however, is not borne out either. The negation marker *không* can co-occur with modals, but emphatic *có* cannot, as shown by (43) and (44).

- (43) Tôi không phải đọc sách
 I neg must read book
 'I don't have to read the book.'
- (44) Minh đã (*có) phải (*có) ăn hối-lộ.
 Minh past emp must emp eat bribe
 'Minh did have to eat bribe.'

If the AsrP in Vietnamese is unmotivated, this in turn undermines the argument that a c-commanding head in AsrP licenses the sentence-final *không*. The next section discusses the analysis of another sentence-final modal-like element *được* and shows that *được* does not support the c-command requirement either; the analysis has an overgeneralization problem.

6.2 Analysis of *được*

Duffield (1999) proposes that the sentence-final *được* is licensed by c-commanding *có thể* in the alethic modalP. Thus, it is predicted that sentence-final *được* should be licensed if a clause allows *có thể* in this position. This prediction, however, is not borne out. In both (45) and (46), *có thể* is allowed

within both the embedded and the main clauses. However, (45) shows that *được* is licensed only by *có thể* in the main clause. In contrast, (46) shows that *được* is licensed only by *có thể* in the embedded clause. This suggests that the c-commanding alethic modal *có thể*⁶ is not a sufficient condition for licensing *được*.

- (45) John (có thể) làm cho Mary (có thể) đi học được.
 John can make Mary can go study *được*.
 ‘John can make Mary go to school.’
 *‘John makes Mary able to go to school.’
- (46) John (có thể) nói rằng Mary (có thể) đi học được.
 John can say that Mary can go study *được*.
 ‘John says that Mary can go to school.’
 *‘John can say that Mary go to school.’

Although I am not in a position to offer an alternative licensing condition for *được*, let me conclude by emphasizing the need to revise existing licensing conditions on the sentence-final elements in Vietnamese.

7. Conclusions

In this paper, I have presented a semantic and syntactic analysis of the Vietnamese causative construction. It was shown that the *làm (cho)* construction is an analytical causative with separate causation and effect predicates that maintain their argument structures. This construction has both direct and indirect causative readings. Moreover, the *làm (cho)* construction shows both mono- and biclausal properties, adding Vietnamese to the set of languages with restructuring in causatives (Shibatani 1976, Moore 1991, Wurmbrandt 2001). If the complement clause is analyzed in terms of reduced structure, it is no longer surprising that the *làm (cho)* construction is monoclausal in terms of TP and CP domains, with its complement clause projecting up to ModalP. The biclausal properties of the construction obviously come from the fact that the construction has two VPs, and the propositions associated with the two VPs induce biclausal properties.

The structure of the causative allowed us to reconsider an earlier proposal concerning Vietnamese clauses structure in general. Duffield's (1999) proposed AsrP, and the analyses of the sentence-final modal elements *được* and *không* are problematic in light of the causative construction. In particular, it was shown that Duffield's c-commanding condition leads to an overgeneralization problem.

Notes

- ¹ I am indebted to Dŭng Đō and Hill Kimloan for their consultations on Vietnamese data. I am also grateful to Maria Polinsky and UCSD classmates for discussion of the paper.
- ² For the full discussion of different interpretations depending on its distribution, please refer to Duffield (1998, 1999).
- ³ It might be possible that *nhau* is a logophor or not even a pronominal at all, considering the wide range of relational terms carrying out the roles of pronominals in Vietnamese. For the present paper, it is enough to show that the use of *nhau* leads to different grammaticality in clear biclausal and *làm (cho)* constructions.
- ⁴ Grammatical judgments for *sẽ* vary. One informant did not accept the sentence as grammatical at all; the other informant initially did not accept the sentence, but later began to accept it as grammatical.
- ⁵ Please refer to Duffield (1999) for the evaluation of the analyses of *duợc* of Simpson's (1997) and Duffield (1998).
- ⁶ *Có thể* is also used as an epistemic modal as mentioned in the section 4. When functioning as an epistemic modal, however, *có thể* occurs before subject position.

References

- Chomsky, Noam. 1965. *Aspects of the theory of syntax*. Cambridge: MIT press.
- Cinque, Guglielmo. 1998. *Adverbs and functional heads: a cross-linguistic perspective*. New York: Oxford.
- Comrie, Bernard. 1989. *Language universals and linguistic typology*. Chicago: The University of Chicago Press.
- Duffield, Nigel. 1998. 'Auxiliary placement and interpretation in Vietnamese', *CLS*, **34**, 95-109.
- Duffield, Nigel. 1999. 'Final modals, adverbs, and antisymmetry in Vietnamese', *Revue québécoise de linguistique*, **27**, 2: 91-129.
- Klima, Edward. 1964. 'Negation in English', In J. Fodor and J. Katz (eds.), *The structure of language*. Englewood Cliffs: Prentice Hall.
- Moore, John. 1991. *Reduced construction in Spanish*. Ph.D. Dissertation. UC-SC.
- Shibatani, Masayoshi. 1976. 'Causativization', In M. Shibatani (ed.), *Syntax and semantics: Japanese generative grammar*. New York: Academic Press.
- Simpson, Andrew. 1997. 'VP-final modals and pied piping in South East Asian', *NELS*, **28**, 89-128.
- Thomas, Margaret. 1988. 'Submissive passives in Vietnamese', *CLS*, **24**, 1: 377-390.
- Wurmbrandt, Susanne. 2001. *Infinitives: restructuring and clause structure*. Berlin: Mouton de Gruyter.

Nayoung Kwon
 Department of Linguistics, UC-San Diego
 9500 Gilman Dr. La Jolla, CA. 92093-0108
nayoung@ling.ucsd.edu

Mixed clitic placement: evidence from Romanian

Ana R. Luís

University of Coimbra, Portugal

1. Introduction

It has been argued that Romanian pronominal clitics trigger non-productive morphophonological alternations and should be analysed as verbal affixes (Barbu 1998, Monachesi 2000)¹. Under this view, clitics attach to the verbal host through inflectional principles. However others have taken a different view about the relation between verbs and clitics: given that clitics in preverbal position may integrate into the preceding syllable, Popescu (2000) and Gerlach (2001) claim that clitics should instead be analysed as syntactic units with a prosodic (rather than morphological) host. In this paper, however, an alternative account of the phonological properties of Romanian clitics will be provided. Based on the assumption that affixes may either select a stem-level or phrase-level host, I offer an inflectional approach that treats pronominal clitics as either stem-affixes or as phrasal affixes, depending on properties of the clause. This proposal differs from Monachesi (2000) who favours a purely stem-level attachment.

In effect, a ‘mixed’ approach to affix placement enables us to explain why clitics undergo and trigger allomorphic variation, on the one hand, and why preverbal clitics can ‘lean’ to their left, on the other. Clitics behave like stem-affixes when they show signs of being morphologically attached to the verb, and constitute phrasal affixes when they are phonologically incorporated into a preceding word. Analysing part of the data in terms of *phrasal* affixation also provides a natural account of the mismatch between the syntactic domain and the phonological host (Klavans 1982, 1985). The characteristic property of phrasal affixes is precisely the fact that the phrasal host need not coincide with the phonological host and this type of mismatch is quite evident in the case of Romanian ‘encliticised’ proclitics given that they are immediately adjacent to the verb (attached presumably to a V^o) but integrated into the preceding word.

An inflectional analysis will be proposed which accounts for both the morphological and phonological behaviour of Romanian pronominal clitics without committing ourselves to the view that phrasal affixes and stem-affixes are two categorially distinct categories. The proposal will be formulated within Paradigm Function Morphology (Stump 2001), in

articulation with recent work by Spencer (2004) and Luís&Spencer (2005). One important property of our model of morphology is the idea that a) placement constraints determine the direction and domain of attachment of affixes and that b) the same affix can select either a verbal-stem or a phrasal node. Thus, crucial to the analysis will be the idea that the same inflectional affix may undergo two modes of attachment, i.e., stem-level and phrasal attachment.

This paper is structured as follows: section 2 lends supporting evidence in favour of the stem-level attachment of Romanian enclitics and proclitics. Section 3 surveys the phonological behaviour of proclitics and suggests that, under certain conditions, Romanian proclitics behave like phrasal affixes. Section 4 then shows that previous inflectional approaches to Romanian cliticisation have failed to accommodate both the morphological and phonological properties of clitics. Section 5 provides an alternative analysis within an extended model of the theory of Paradigm Function Morphology. This is followed in section 6 by a short summary.

2. Pronominal Clitics as Stem-level Affixes

This section examines the grammatical status of Romanian pronominal based on standard criteria for the definition of affix status, such as rigid ordering, co-occurrence restrictions, idiosyncratic shape alternations and clitic doubling². In addition, I also discuss morphophonological effects taking place at the boundary between the verb and clitics which clearly show the attachment between verbs and clitics is morphological.

2.1 The clitic sequence

It has often been mentioned in the literature that clitic sequences exhibit very robust affix properties. These include a) clitic ordering, b) co-occurrence restrictions and c) morphological idiosyncrasies (Monachesi 2000, Gerlach 2001).

The rigid order of clitics resembles the invariable order in which affixes are linearized. As shown in (1) below, Romanian clitics can only occur in the dative-accusative order. Such order is unmotivated from a syntactic point of view, but resembles the arbitrariness of affix ordering.

- (1) i -l dau
 dat.3sg acc.3sg.masc give.1sg
 'I give it to him'

In addition, specific restrictions apply inside the clitic cluster preventing certain dative-accusative combinations from surfacing. As the table below shows, first person dative clitics cannot co-occur with first person singular nor with first and second plural accusative clitics. As repeatedly argued in the literature, there are no syntactic principles that could account insightfully for such combinatorial limitations and therefore such idiosyncratic restrictions seriously weaken the word status of clitics.

Likewise the morphophonological alternations illustrated in Table 1 do not follow from productive phonological rules, but indicate that adjacent clitics behave like sequences of affixes. When plural datives such as *ne*, *vă* and *le* are followed by accusative clitics they surface as *ni*, *vi*, *li*; however if *ne* and *le* are followed by the feminine accusative clitic *-o*, such vowel raising is overruled. Evidence then suggests that shape variation is triggered by the morphosyntactic features of the adjacent pronoun, strongly supporting the affixal properties of the clitic sequence.

Table 1 (Popescu 2000)

IO		1sg	2sg	3sg	1pl	2pl	3pl
		îmi	îți	îi	ne	vă	le
1sg	mă	-	-	-	-	-	-
2sg	te	<i>mi-te</i>	-	<i>i-te</i>	<i>ni-te</i>	-	<i>li-te</i>
3sg.m	îl	<i>mi-l</i>	<i>ți-l</i>	<i>i-l</i>	<i>ni-l</i>	<i>vi-l</i>	<i>li-l</i>
3sg.f	o	<i>mi-o</i>	<i>ți-o</i>	<i>i-o</i>	<i>ne-o</i>	<i>vi-o</i>	<i>le-o</i>
1pl	ne	-	-	-	-	-	-
2pl	vă	-	-	-	-	-	-
3pl.m	îi	<i>mi-i</i>	<i>ți-i</i>	<i>i-i</i>	<i>ni-i</i>	<i>vi-i</i>	<i>li-i</i>
3pl.f	le	<i>mi-le</i>	<i>ți-le</i>	<i>i-le</i>	<i>ni-le</i>	<i>vi-le</i>	<i>li-le</i>

The phenomenon of *î*-initial deletion also takes place inside the clitic sequence, when *î*-initial clitics occur in one of the three following positions: dative position (e.g., *mi-te*), accusative position (e.g., *ni-l*) or both (e.g., *ți-l*). Phonological studies by Popescu (2000) and Gerlach (2001) argue that vowel deletion results from regular phonological constraints such as the need to minimise syllable structure or avoid vowel adjacency. However the problem with regarding these phenomena as phonological is that they have a very their restricted context of occurrence: in effect, these phenomena are all triggered by the presence of clitics. Under a phonological analysis, then, they can only be regarded as clitic-specific phonological rules, not general rules. The need to formulate ad-hoc rules is indicative of idiosyncrasy of the shape variation and supports their morphological status.

In addition, the putative regularity of *î*-deletion will be re-examined in section 2.3 where I will show that this phonological alternation also displays an idiosyncratic pattern when it occurs at the boundary between a verb and an enclitic.

2.2 Distribution

Since agreement phenomena are typically inflectional in nature, the ability for clitic pronouns in Romanian to optionally co-occur with full NP complements as in (2) clearly weakens the idea that clitics constitute autonomous word units and supports their status as agreement markers.

- (2) Ion m- a văzut pe mine. (Monachesi 2000)
 Ion acc.1sg has seen pe me
 ‘Ion saw me’

Other distributional properties include the obligatory repetition on each member of a verbal conjunct. Narrow scope is a typical property of affixes and illustrated in (3a) where proclitics must be immediately adjacent to the verb.

- (3) a. El te dorea și te căuta. (Monachesi 2000)
 he acc.2sg desires and acc.2sg looks for
 ‘He desires you and looks for you.’
 b. *El te dorea și căuta.

2.3 Morphophonological effects

The affix status of clitic pronouns is also supported by morphophonological effects that take place at the boundary between the clitic and the verb. The phenomena addressed in this section include *-ă/-e* deletion (on proclitics), *i-deletion* (on enclitics) and *-u* epenthesis (on gerund verb forms).

As alluded to in section 2.1, previous studies have formulated phonological constraints to account for the shape alternations suffered by clitics and verbs. Given that these alternations are clitic-specific (hence, not phonologically productive), I maintain the view that they should be regarded as morphophonological alternations (cf. section 2.1). This idiosyncrasy will be strengthened in this section with data showing that so-called ‘phonological’ rules are effectively far less regular than generally assumed.

Let us start with vowel-final deletion of *-ă* [ə] / *-e* [e]. This deletion occurs when clitics such as *mă-* [mə], *vă-* [və] and *se-* [se] (cf. Table 2) precede a verb beginning with unstressed *a-* or *o-*, as shown in (4). In Popescu (2000) and Gerlach (2002) the view is taken that such vowel deletion results from the need to avoid a hiatus and to minimise the number of syllables.

- (4) m- așteaptă
 acc.1sg waits
 ‘s/he waits for me’

Table 2

	Dative			Accusative					
	1pl	2pl	3pl	1sg	2sg	1pl	2pl	3pl.f	3ref
Proclitics	<i>ne</i>	<i>vă</i>	<i>le</i>	<i>mă-</i>	<i>te</i>	<i>ne</i>	<i>vă</i>	<i>le</i>	<i>se</i>
		<i>v</i>		<i>m</i>			<i>v</i>		<i>s</i>
Enclitics	<i>ne</i>	<i>vă</i>	<i>le</i>	<i>mă</i>	<i>te</i>	<i>ne</i>	<i>vă</i>	<i>le</i>	<i>se</i>

The problem with the phonological explanation of vowel-final deletion is illustrated in (5) where proclitics with the same phonological structure fail to undergo this type of deletion: clitics such as *le-* [le], *te-* [te], and *ne-* [ne], which exhibit the same vowel as *se-* [se], do not exhibit a truncated form.

- (5) *t-/te așteaptă
 acc.2sg waits
 ‘s/he waits for you.sg’

This shows that $-ă[ə]$ / $-e[e]$ deletion cannot be triggered by the phonological properties of clitics and that the phenomenon is clearly restricted to a specific set of clitic pronouns in preverbal position. Under this view, truncated proclitic forms in Table 2 should be regarded as genuine clitic allomorphs.

Let us now examine the phenomenon of *u*-epenthesis. This vowel surfaces when gerund verbs are followed by an enclitic, as shown in (6), where the epenthetic *-u* vowel surfaces between the verb and the enclitic.

- (6) a. spălând
 ‘wash.gerund’
 b. spălându-te
 ‘wash.gerund acc.2sg’

The fact that gerund verbs only undergo shape variation in the presence of clitics is already a clear sign that verbs are morphophonologically sensitive to clitics. Phonological and syntactic accounts take a different view (Popescu 2000, Dobrovie-Sorin 1999): *u*-epenthesis in (6) takes place only because consonant-initial clitics cannot follow a consonant-final verb.

While this phonological explanation appears to be well-motivated for the data in (6) and for all the consonant-initial clitics in Romanian (cf. Table 2), it is not obvious that vowel-initial clitics (cf. Table 3) also trigger *u*-epenthesis for ‘phonological reasons’.

Table 3

	Dative				Accusative	
	1sg	2sg	3sg	3ref	3sg.m	3pl.m
Proclitics	<i>îmi</i>	<i>îți</i>	<i>îi</i>	<i>își</i>	<i>il</i>	<i>ii</i>
Enclitics	<i>mi</i>	<i>ți</i>	<i>i</i>	<i>și</i>	<i>l</i>	<i>i</i>

The difference between clitics in Table 2 and in Table 3 is that the latter are vowel-initial in their default position (i.e., preverbally) while the former are consonant-initial. One would expect vowel-initial clitics to be selected with gerund verb forms, and preempt *-u* epenthesis, as in (7). Both the default form of gerund verbs and the default form of these clitics provide an optimal syllable structure.

- (7) *amintind-îmi [mʲ]

But, that does not happen in Romanian. Instead, what we find is that gerunds combine with the truncated forms in Table 3, as shown in (8), even though there is no phonological argument for (7) to be more optimal than (8). The syllable structure in either case is exactly identical.

- (8) amintind-u-mi [mʲ]
 remembering-u-dat.1sg
 ‘remembering myself’

Given that epenthetic *-u* also surfaces with truncated *î*-initial clitics, the questions we need to ask are a) why is the *-u* vowel inserted? and b) why does *î*-deletion apply to the enclitic? As to b), the phonological motivation for *î*-deletion (i.e., vowel adjacency caused by enclitics preceded by positive imperatives, as in (9)), it is not clear that the same explanation can hold for the data in (7) because gerund verbs are consonant-final by default (unlike positive imperatives).

- (9) a. arată-l [a.ra.təl] b. *arătă il [a.ra.tə.il]
 show.imp acc.3sg.masc
 ‘show him’

As to a), *-u* insertion is arguably triggered by consonant-initial clitics. While that phonological explanation may seem to hold in (6), as alluded to before, it cannot explain (7a) because the form of the enclitic has already been subject to vowel truncation (putatively triggered by a vowel-final verb).

The phonological motivation for *î*-deletion and *u*-epenthesis fails to hold if both phenomena co-occur within the same verb-enclitic combination (as in (8)). The puzzle is that *î*-deletion and *u*-epenthesis in (8) are mutually triggered (i.e., vowel-final gerunds trigger *î*-deletion and *î*-deletion triggers *u*-epenthesis) in ways which cannot be defined in purely phonological terms. It therefore cannot be claimed that *î*-deletion and *u*-epenthesis constitute ‘regular’ phonological rules.

Changes triggered by adjacent units are problematic and unnatural for a phonological account, but completely unproblematic within inflectional morphology where reciprocal allomorphy between verbs and affixes is recurrent. Similar reciprocal effects involving clitics are attested in European Portuguese between consonant-final verbs and clitics. As shown in (10a), the adjacency between *s*-final verbs and vowel-initial enclitics triggers allomorphy on the enclitic and on the verb. The same type of alternation occurs within the clitic cluster as shown in (10b).

- (10) a. leva-lo (*levas-o)
 take.2sg acc.3sg.masc
 ‘(you) take it’
 b. no-los (*nos-o)
 dat.2pl-acc.3pl.masc

Having re-analysed standard claims about *u*-epenthesis and *î*-deletion, I have shown that these phenomena should be regarded as idiosyncratic morphophonological alternations, rather than as regular (clitic-specific) phonological rules. Although diachronically there may have been a phonological motivation, I take the view that *u*-insertion should be analysed as instance of stem allomorphy induced by clitic suffixes. This explanation reinforces the affix status of clitics and show that Romanian clitics have effectively the ability to trigger shape variation on the preceding verbal host.

2.4 Summary

The evidence surveyed in this section supports the inflectional status of Romanian clitics. Phenomena such as a) strict adjacency, b) narrow scope, c) clitic doubling, d) rigid clitic ordering, e) co-occurrence restrictions and f) allomorphic alternations have shown that Romanian proclitics and enclitics are best analysed as morphologically attached verbal affixes. Similar claims have been made for other Romance languages based on a identical set of affix properties (Auger 1994 and Miller&Sag 1997, for French, Monachesi 1999 for Italian, Luís 2004 for European Portuguese).

3. Preverbal Clitics Revisited

As pointed out in Popescu (2000) and Gerlach (2001), under certain conditions, proclitics can also attach phonologically to their left³. This pattern is illustrated in (11), where the phonological representation shows that proclitics are integrated into the preceding syllable.

- (11) a. Mama-l [ma.mal.] place. (Popescu 2000)
 mother acc.3sg.masc likes
 ‘mother likes him’
- b. Maria-i [ma.ri.a^l.] scrie des. (Dobrovie-Sorin 1999)
 Maria dat.2sg writes frequently
 ‘Maria writes him/her frequently’
- c. Nu ştie că-l [kəl.] aşteaptă mama (Dobrovie-Sorin 1999)
 not knows that-acc.3sg.masc waits mother
 ‘s/he doesn’t know that mother waits for him’
- d. Unde-mi [un.dem^l.] aduce? (C. Iscrulescu, pc.)
 where-dat.1sg brings
 ‘where does s/he bring me?’

The phonological promiscuity of proclitics clearly fails to support the claim that clitics constitute stem-level affixes: in (11a-b), proclitics attach to nouns; in (11c), to a complementiser; in (11d), to a wh-pronoun. Although typical affixes attach to one category only, the fact that proclitics in (11) select different categories need not rule out their status as *affixes*.

In fact, despite their phonological behaviour, the proclitics in (11) share with their morphologically attached counterparts (in section 2) important properties which are worth taking into account: on the one hand, they can be doubled (cf. 2.2) and on the other they are phonologically exactly identical to enclitics. Such similarities suggest that the proclitics in (11) do belong to an entirely different category and that it may be more insightful to accommodate the exceptional behaviour of ‘encliticised’ proclitics within an overall inflectional account rather than to treat them as function words.

In this paper, therefore, I argue that the data in (11) does not weaken their affix status. Instead it indicates that preverbal clitics in Romanian also behave like *phrasal* affixes. That is, they are affixes which select a phrasal

host rather than a verbal stem. One of the crucial properties of phrasal affixes, as shown in Klavans (1982, 1985), is precisely the fact that they are syntactically attached to one domain but phonologically bound to a domain with which they are not semantically related. In (11), the phrasal host is clearly the V^o node under which verbs are positioned. Note that proclitics, despite the different phonological hosts, appear in the same preverbal syntactic position.

This section then has argued that Romanian proclitics in (10) share significant properties with the verbally attached clitics (cf. section 2) and should therefore not be analysed as word units but as phrasal affixes.

4. Clitics as Phrasal Affixes

For some linguistics, phrasal affixation has been viewed as a synonym for cliticisation *tout court*. Authors such as Anderson (1992, 1995, among other) treat entire clitic systems in various languages as the morphology of phrases. Legendre (2000) adopts the same view for Romanian pronominal clitics which, under her view, behave in all contexts like phrasal affixes.

In line with the theory formulated originally in Anderson (1992), Legendre develops an analysis based on the assumption that the data does not support the morphological attachment of Romanian pronominal clitics to the verb. However, it is far from obvious how the genuine morphological behaviour examined in section 2 can be accounted for if the 'bond' between clitics and the verb is phonological. Presumably through some sort of clitic-specific phonological constraints, given that the alternations do not apply productively elsewhere. So, one of the problems with Legendre's view is the wide range of morphological and morphophonological data displayed by clitics.

From the point of view of clitic distribution, it also seems highly redundant to define a phrasal node for clitics that are bound to the verb by default. In other words, the phonological and syntactic domain of proclitics and enclitics is by default exactly the same, namely the verb. In addition, treating all clitics as phrasal affixes blurs the empirical distinction between pro/enclitics that integrate into the verb (cf. section 2) and proclitics that integrate into a different category (cf. section 3).

In addition, the idea that all clitics are phrasal affixes is also problematic from the point of view of the clitic cluster. Again, the morphophonological effects fall out naturally if clitic sequences are derived as morphological units, prior to their placement in preverbal or postverbal position (Monachesi 1999, Luis 2004), but not if clitic clusters are derived as sequences of phrasal affixes. The unity of the cluster is also endorsed by Gerlach (2001). Thus an important aspect about the inflectional analysis proposed in this paper is that, regardless of whether clitics are stem-affixes or phrasal-affixes, clitic clusters are attached to a verb stem or to a phrasal node as whole inflectional sequences. In Anderson (1995) and Legendre (2000), however, phrasal affixation defines the attachment of each individual clitic, not of the cluster as a whole.

To sum up, the complexity of the Romanian data cannot be accommodated by treating clitics uniformly as phrasal affixes. Instead a ‘mixed’ inflectional approach must be adopted, one that captures the predominantly morphological behaviour of the clitic system (examined in section 2) in addition to the exceptional phrasal behaviour of the proclitics (examined in section 3)⁴.

5. Proposal

The analysis of Romanian clitics will be formulated within the theory of Paradigm Function Morphology (Stump’s 2001) in articulation with the proposals made by Luís (2004), Luís and Spencer (2005) and Spencer (ms.) for clitic phenomena.

An important device in PFM is the Paradigm Function (PF) which takes as its argument a pair comprising a root of a lexeme (L) and a complete set of morphosyntactic features associated with that lexeme (σ) and delivers as output an inflected form of that lexeme. Following Spencer (2004, ms), we define the PF as in (12):

- (12) PF (<Lexeme, σ >) =_{def}
 STEM: selection of stem
 EXPONENCE: form of the affixes
 HOST: morphological or phrasal category to which affixes attach
 LINEARISATION: position of affixes with respect to host

(12) illustrates the subfunctions that make up the PF: STEM selects the appropriate stem of the lexeme; EXPONENCE defines the form of the affix through a realization rule (RR); the HOST specifies where within that domain the affix is placed and LINEARIZATION positions the affix with respect to the host. Crucial to our model of morphology is the separation between the realisation of the affix (EXPONENCE), on the one hand, and its placement with respect to the host (LINEARIZATION), on the other. Unlike in classical models, the form of an affix and its direction of attachment are not conflated, making it possible for a given affix to undergo different modes of linearization. Let us see how the PF work with typical stem affixation in (13) and (14).

- (13) *dă-le* ‘give them!’ (suffixation)

PF (<GIVE, {(Case: Dat, Person:2, Number: pl); Tense: Pos.Imp, Person: 2; Number: sg}>)=_{def}

STEM:	<i>dă</i>
EXPONENCE:	<i>le</i>
HOST:	stem
LINEARIZATION:	right

A simple illustration of prefixation and suffixation is given in (13) and (14) for the Romanian third person plural dative clitic <le>⁵. In (13), the PF defines cliticisation as verbal suffixation by aligning the affix *le* to the right of the verbal stem *dă*. Thus, suffixation is analysed as a postverbal mode of affix attachment. For simplicity, the stem already carries tense and subject agreement features which trigger enclisis.

The separation between affix realisation and affix placement allows the same affix to be associated with different placement constraints. In (14), the preverbal mode of attachment which aligns the exponent to the left of a finite verb stem.

(14) *te place* ‘s/he likes you.sg’ (prefixation)

PF (<LIKE, {(Case: Acc, Person:2, Number: Sg); Tense: Pres.Ind, Person:3; Number: sg}>) =_{def}

STEM:	<i>place</i>
EXPONENCE:	<i>te</i>
HOST:	verb
LINEARIZATION:	left

The properties that trigger prefixation and suffixation in Romanian are, as in most Romance languages, the tense features of the verb. In Romanian, in particular, clitics are postverbal with gerund verbs and positive imperatives, and preverbal elsewhere. Thus, the tense features defined in (13) are non-finite as opposed to the finite features defined in (14).

In the case of phrasal affixation, however, it seems that tense features interact with other factors, given that phrasal affixation appears to take place under a very specific and restricted set of conditions. The intervening factors may be pragmatic or/and, however more research will be necessary to determine the ways in which they interact with the morphology in clitic placement^{6/7}. Bearing in mind the caveat that phrasal affixation is triggered by factors other than the tense features of the verb, the PF in (15) offers a simple illustration of how phrasal affixes may be captured within PFM.

(15) *mi aduce* ‘s/he brings me’ (phrasal affixation, cf. (11d))

PF (<BRING, {(Case: Dat, Person:1, Number: Sg); Tense: Pres.Ind, Person:3; Number: sg}>) =_{def}

STEM:	<i>aduce</i>
EXPONENCE:	<i>mi</i>
HOST:	V°
LINEARIZATION:	left

The phrasal attachment of an affix is captured by defining a phrasal node rather than a verbal stem for the clitic affix. While the HOST parameter in

(13) and (14) determines a verbal stem, for phrasal affixation it must define a phrasal node. In the case of Romanian proclitics, I assume that the host is a V^o node, given that proclitics are always obligatorily adjacent to the verb⁸.

As alluded to before, phrasal affixation can display a mismatch between the syntactic host and the phonological host. In (15), the LINEARIZATION parameter defines the syntactic host, positioning the affix to the left edge of the syntactic V^o node. However, the phonological host, namely the word immediately preceding the clitic, is not defined. Different proposals can be made, depending on one's theory of grammar and on the relationship between morphology and phonology. In principle, the direction of attachment can be captured prosodically by determining that phrasal affixes attach to the preceding prosodic word in combination with rules of resyllabification which integrate the clitic into the preceding syllable. In earlier studies, Berendsen (1986) and Anderson (1992) have also alluded to Stray Adjunction to account for the mismatch between syntax and phonology⁷. Alternatively, the direction of phonological attachment can be defined by an additional 'liaison' parameter in the PF, in a style that would resemble the theory of Klavans (1982).

6. Summary

The goal of this paper has been to argue that cliticisation in Romanian combines two modes of affix placement: a) placement with respect to a stem in postverbal and preverbal position, and b) placement with respect to a phrasal node in preverbal position. The latter type of attachment appears to be the result of pragmatic and phonological factors, although the exact conditions triggering this pattern remain to be clarified.

Theoretically, I have shown that the theory of PFM provides linearization constraints that can align the same exponent either to the left or to the right of a verbal stem, deriving prefixation and suffixation, or to the left (or right) of a phrasal node, deriving phrasal affixation. Other instances of mixed clitic placement have been attested for European Portuguese (Luís 2004) and Udi (Luís&Spencer to appear).

Notes

¹ I thank Cristian Iscrulescu for helping me with the data and providing examples. I also thank Ryo Otoguro and the participants at Wecol 2004 for comments and suggestions. For financial support, I thank the Fundação Luso-Americana para o Desenvolvimento (FLAD) and the Fundação Calouste Gulbenkian (FCT).

² The distinction between words and affixes is based on criteria proposed by Zwicky&Pullum (1983), and unless stated otherwise, the data used in this paper is taken from Monachesi (2000), Popescu (2000) and Gerlach (2001).

³ It seems that 'encliticised' proclitics are not in free variation with prefixed proclitics, given that they are more predominant in the informal language. Pragmatic conditions, for example, may trigger phonological encliticisation of proclitics, however more research is necessary to determine the exact context within which the phenomenon occurs. See also footnote 6.

⁴ Other instances of mixed clitic placement have been attested for European Portuguese (Luís 2004) and Udi (Luís&Spencer to appear).

⁵ For a more detailed illustration of how this model of morphology works, see Stump (2001), Spencer (2004), Luís&Spencer (2005) and Luís&Spencer (to appear).

⁶ Despite the pragmatic trigger (cf. footnote 3), certain phonological contexts seem to disallow the encliticisation of proclitics. In the speech of one of my informants, consonant-initial proclitics cannot encliticise onto consonant-final words, as in (e.g., *[kəndmʲ] in **Cănd-mi scrie Ion* ‘When does John write to me?’). It appears that proclitics can only be integrated into a preceding word that ends in a vowel, although more research about the phonology of procliticisation must be carried out.

⁷ For proposals on how to allow the morphology to interface with other levels of grammar, cf. Luís&Otoguro (2004).

⁸ Phrasal attachment to V^o is also proposed in Legendre (2000) for the entire clitic system, rather than for phonologically incorporated proclitics as proposed in the present study.

References

- Anderson, Stephen. 1992. *A-Morphous Morphology*. Cambridge Studies in Linguistics 62. Cambridge: CUP.
- Anderson, Stephen R. (1995) Rules and Constraints in Describing the Morphology of Phrases. *CLS Parasession on Clitics*. Chicago Linguistic Society, pp. 15-31.
- Andrews, Avery. 1990. “Unification and Morphological Blocking”. *Natural Language & Linguistic Theory*, **8**; pp. 507-557.
- Barbu, Ana-Maria. 1998. “Complexul verbal”. App.: Studii și Cercetări Lingvistice, București.
- Berendsen, Egon. 1986. *The Phonology of Cliticization*. Dordrecht: Foris.
- Bresnan, Joan. 2001. *Lexical Functional Syntax*. Oxford: Blackwell.
- Dobrovie-Sorin, Carmen. 1999. “Clitics across categories: The case of Romanian”. In: Henk van Riemsdijk (ed.) *Clitics in the Languages of Europe*. Berlin: Mouton de Gruyter, pp. 515-540.
- Gerlach, Birgit. 2001. *Clitics Between Syntax and Lexicon*. PhD thesis, Heinrich-Heine Universität, Düsseldorf.
- Klavans, Judith. 1982. *Some Problems in a Theory of Clitics*. Bloomington: Indiana University Linguistics Club.
- Klavans, Judith. 1985. “The Independence of Syntax and Phonology in Cliticisation”. *Language*, **61**; pp. 95-120.
- Legendre, Géraldine. 2000. “Positioning Romanian Verbal Clitics at PF: an Optimality-Theoretic Analysis”. In: Birgit Gerlach and Janet Grijzenhout (eds.) *Clitics in Phonology, Morphology, and Syntax*. John Benjamins Publishing Company: Amsterdam/Philadelphia, pp. 219-254.
- Luís, Ana. 2004. *Clitics as Morphology*. Unpublished PhD dissertation, University of Essex.
- Luís, Ana. 2003. “On the Inflectional Status of Pronominal Clitics”. M. Cazzoli-Goeta, M. Heather and S. Pourcel (eds.) *Durham Working Papers in Linguistics*, **9**; pp. 25-38.
- Luís, Ana and Ryo Otoguro. 2004. Proclitic contexts in European Portuguese and their effect on clitic placement. In *Proceedings of the LFG04 Conference*, ed. by Miriam Butt and Tracy Holloway King, 334–353, Stanford, CA. CSLI Publications.
- Luís, Ana and Andrew Spencer. To appear. “Udi Clitics: a Generalized Paradigm Function Morphology Approach”. In Ryo Otoguro, et al. (eds.) *Essex Research Reports in Linguistics*. Department of Language and Linguistics, University of Essex.
- Luís, Ana and Andrew Spencer. 2005. “A Paradigm Function account of ‘mesoclitisis’ in European Portuguese”. *Yearbook of Morphology 2004*, 177—228.

- Miller, P. and I. Sag. 1997. "French Clitic Movement without Clitics or Movement". *Natural Language and Linguistic Theory*, 15.3; pp. 573-639.
- Monachesi, Paola. 1999. *A Lexical Approach to Italian Cliticization*. CSLI, Stanford.
- Monachesi, Paola. 2000. "Linearization properties of Romanian Clitics". In: Birgit Gerlach and Janet Grijzenhout (eds.) *Clitics in Phonology, Morphology, and Syntax*. Amsterdam/Philadelphia: John Benjamins; pp. 255-293.
- Popescu, Alexandra. 2000. "The morphophonology of the Romanian clitic sequence". *Lingua* 110, pp. 773-799.
- Spencer, Andrew. 2004. "Generalized Paradigm Function Morphology – A synopsis". *York Papers in Linguistics* 2.2. Department of Language Science and Linguistics, University of York.
- Stump, Gregory T. 2001. *Inflectional Morphology. A Theory of Paradigm Structure*. Cambridge: Cambridge University Press.
- Zwicky, A. and G. Pullum (1983) "Cliticization vs. Inflection: English n't". *Language*, 59.3; pp. 502-512.

Ana R. Luís
University of Coimbra
Portugal
aluis@fl.uc.pt

Non-reflexive Non-argumental Clitic Pronouns of Spanish

Jonathan E. MacDonald
Stony Brook University

1. Introduction

This paper discusses non-reflexive non-argumental clitic pronouns of Spanish (non-reflexives). Examples are given in (1-2). The non-reflexives are in bold. Two seemingly independent facts of these non-reflexives have resisted a unified explanation: **1.** Non-reflexives resist adjectival secondary predication (3), and **2.** Non-reflexives can prevent idiomatic interpretation (4). In this paper, I offer an account of these facts.

- (1) Yo **le** lavé el coche.
I **to-him** washed the car.
'I washed **his** car.' or 'I washed the car **on/for him**.'
- (2) Juan **me** bebió la cerveza.
Juan **to-me** drank the beer
'Juan drank **my** beer.' or 'Juan drank the beer **on/for me**.'
- (3) Yo_j **le**_k lavé el coche borracho_{j/*k}.
I_j **to-him**_k washed the car drunk_{j/*k}
'I washed **his** car drunk.' or 'I washed the car **on/for him** drunk.'
- (4) a. Juana bebe los vientos por Javier.
Juana drinks the winds for Javier
Idiomatic meaning: 'Juana is in love with Javier.'
- b. #Juana **me** bebe los vientos por Javier.
Intended meaning: 'Juana is in love with Javier **on me**.'

I propose that non-reflexive non-argumental clitic pronouns of Spanish are introduced as the complement of a null directional-like preposition that merges as a complement of the verb (5).

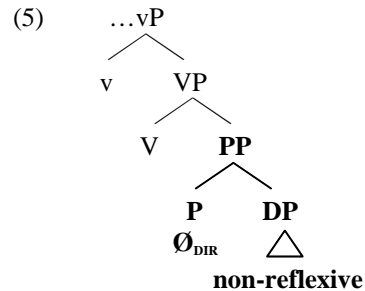

Not only does this proposal account for the lack of adjectival secondary predication (3) and the prevention of idiomatic interpretation (4), it also explains some obvious parallels between properties exhibited by the non-reflexive and overt directional prepositions; namely, the inability to elicit a telic interpretation of the predicate, and the inability to express an *on/with* entailment.

The paper is structured in the following way: In section 2, I draw out the properties of non-reflexive non-argumental clitic pronouns of Spanish by contrasting them with **reflexive** non-argumental clitic pronouns of Spanish. We see that non-reflexives pattern with directional prepositions, while the reflexives pattern with goal prepositions. In addition to these patterns, I draw attention to another contrast: the non-reflexive's ability to express a temporary relation between the direct object and the denotation of the non-reflexive, and the reflexive's **inability** to express this temporary relation. In section 3, I lay out the main hypothesis that these non-reflexives of Spanish are complements of a null directional-like preposition that merges as the complement of the verb. I detail how this proposal straightforwardly accounts for the non-reflexive's resistance to adjectival secondary predication and its ability to prevent idiomatic interpretation. In section 4, I address another contrast between the reflexive and the non-reflexive that arises when they occur with a particular idiom.

2. The Properties of Spanish Non-reflexives

In this section, I discuss properties of non-reflexive non-argumental clitic pronouns of Spanish. These properties take on significance when contrasted with properties of **reflexive** non-argumental clitic pronouns of Spanish (reflexives). The contrast centers on three properties: **1.** The (in)ability to elicit a telic interpretation of the predicate, **2.** The (in)ability to express an *on/with* entailment, and **3.** The (in)ability to express temporary relations. Reflexives elicit a telic interpretation of the predicate, express an *on/with* entailment, but cannot express temporary relations. Non-reflexives do not elicit a telic interpretation of the predicate, do not express an *on/with* entailment, but can express temporary relations.

To conclude this section, I compare these pronouns of Spanish with overt goal and directional prepositions. Goal prepositions elicit a telic interpretation of the predicate and express an *on/with* entailment. Directional prepositions do not elicit a telic interpretation of the predicate and do not express an *on/with* entailment. Reflexives pattern with goal prepositions and non-reflexives pattern with directional prepositions.

2.1 Eliciting a telic interpretation of the predicate

It has been observed that in the presence of a reflexive pronoun of Spanish the predicate is interpreted as telic (MacDonald 2004, Nishida 1994, Sanz 2000, Zagona 1996). Durative phrases (e.g. *durante una hora* ‘for an hour’) are incompatible with telic events (see Dowty 1979, Tenny 1994 among others). Observe that the reflexive pronoun is incompatible with the durative phrase (6), where otherwise it would be.

- (6) (Yo) **me** lavé el coche # durante una hora.
 (I) **myself** washed the car # for an hour
 ‘I washed the car for an hour.’

In contrast, observe that non-reflexives are compatible with durative phrases (7). Non-reflexives do not elicit a telic interpretation of the predicate.

- (7) (Yo) (**le**) lavé el coche durante una hora.
 (I) (**to-him**) washed the car for an hour
 ‘I washed his car for an hour.’ or ‘I washed the car on/for him for an hour.’

Thus, the presence of the reflexive pronoun elicits a telic interpretation of the event. The presence of the non-reflexive does not.

2.2 Expressing an *on/with* entailment

A curious restriction has been observed when reflexive pronouns are present in an utterance (MacDonald 2004). The location of the event expressed by the verb is restricted to the location of the subject. This can be observed in (8).

- (8) a. (Yo) **me** abroché la camisa.
 (I) **myself** buttoned the shirt
 ‘I buttoned the shirt.’
 b. (Yo) **me** lavé el coche.
 (I) **myself** washed the car.
 ‘I washed the car.’

In (8a), the shirt is necessarily interpreted as on the subject at the time of the buttoning event; the shirt could not be on a hanger while the shirt is being buttoned. In (8b), the subject is necessarily interpreted as carrying out the action of washing the car; he could not have dropped it off at a carwash and let someone else wash it for him.

MacDonald (2004) proposes that the presence of the reflexive forces the direct object to be necessarily interpreted as *on/with* the denotation of the reflexive. As the reflexive is co-indexed with the subject, the direct object is interpreted as necessarily *on/with* the denotation of the subject. Given that the action expressed by the verb is carried out on the direct object, which is interpreted as *on/with* the subject, the subject marks the location of the event. The event expressed by the verb is restricted to the location of the subject because the presence of the reflexive forces the direct object to be necessarily interpreted as *on/with* the denotation of the reflexive.¹

Compare the data with the reflexives in (8) to the data with non-reflexives in (9).

- (9) a. (Yo) **le** abroché la camisa.
 (I) **to-him** buttoned the shirt
 'I buttoned his shirt.' or 'I buttoned the shirt on/for him.'
- b. (Yo) **le** lave el coche.
 (I) **to-him** washed the car
 'I washed his car.' or 'I washed the car on/for him.'

In (9a), the shirt is **not** necessarily interpreted as on the denotation of the non-reflexive at the time of the buttoning event. The individual denoted by the non-reflexive does not have to be wearing the shirt; the shirt could be on hanger at the time of buttoning. In (9b), the denotation of the non-reflexive does **not** necessarily have to be present during the washing of the car, let alone be carrying out the washing himself. The car could have been dropped off at a carwash to let someone else wash it while the individual denoted by the non-reflexive was at some other location.

When the non-reflexive pronoun is present, the direct object is **not** necessarily interpreted as *on/with* the denotation of the non-reflexive. When the reflexive pronoun is present, the direct object is necessarily interpreted as *on/with* the denotation of the reflexive. The reflexive expresses an *on/with* entailment. The non-reflexive does not.

2.3 Expressing temporary relations

It has been observed that under certain pragmatic conditions, the presence of the reflexive pronoun is not licensed (MacDonald 2004). One of those conditions is when the direct object is temporarily related to the denotation of the reflexive.

Thus, in (10), the reflexive pronoun is not licensed in the following context: I am a car-washer and I am temporarily assigned cars to wash as part of my job.

- (10) #(Yo) **me** lavé el coche.
 (I) **myself** washed the car.
 'I washed the car.'

I wash a car temporarily assigned to me and wish to express this. I cannot express this by uttering the sentence in (10) with the reflexive pronoun. In a similar car-washer scenario, in which I do my fellow car-washer colleague a favor and wash his car for him, I **can** express this with the non-reflexive pronoun, as in (11).

- (11) (Yo) **le** lavé el coche.
 (I) **to-him** washed the car
 'I washed his car.' or 'I washed the car on/for him.'

An individual is temporarily assigned a car as part of his job. I wash it for him, and I can express this by uttering sentence (11) using the non-reflexive to denote that individual. The reflexive pronoun cannot express a temporary relation between the direct object and the denotation of the clitic. The non-reflexive pronoun can.

To briefly summarize, we can contrast constructions that contain a **non-reflexive** non-argumental clitic pronoun of Spanish with constructions that contain a **reflexive** non-argumental clitic pronoun of Spanish on three points: **1.** The (in)ability to elicit a telic interpretation of the predicate, **2.** The (in)ability to express an *on/with* entailment, and **3.** The (in)ability to express temporary relations. Reflexives elicit a telic interpretation of the predicate, express an *on/with* entailment, but cannot express temporary relations. Non-reflexives do not elicit a telic interpretation of the predicate, do not express an *on/with* entailment, but can express temporary relations.

2.4 Goal and directional prepositions exhibit parallel properties

In this section, I draw a parallel between properties of goal prepositional phrases and reflexives, and between directional prepositional phrases and non-reflexives. It will be shown that goals pattern with reflexives by eliciting a telic interpretation of the predicate and by expressing an *on/with* entailment. Directionals pattern with non-reflexives by not eliciting a telic interpretation of the predicate and by not expressing an *on/with* entailment.

Observe that goal prepositional phrases, like reflexives, are not compatible with the durative phrase (12a), while directional prepositional phrases, like non-

reflexives, are (12b). Like reflexives, goal prepositional phrases delimit the event. Like non-reflexives, directional prepositional phrases do not.

- (12) a. Ralph pushed the car **to the garage** #for an hour.
 b. Ralph pushed the car **toward the garage** for an hour.

Observe that goal prepositions, like reflexives, express an *on/with* entailment (13a), while directional prepositions, like non-reflexives, do not (13b).

- (13) a. Ralph threw the ball **to Frank**.
 b. Ralph threw the ball **toward Frank**.

In (13a), the goal preposition expresses the entailment that the ball ends up in Frank's possession; it is necessarily *on/with* Frank. In (13b), there is no such *on/with* entailment expressed by the directional; the ball may or may not end up in Frank's possession.

Thus, goal prepositional phrases and reflexive pronoun constructions pattern together on the one hand, while directional prepositional phrases and non-reflexive pronoun constructions pattern together on the other. These parallel patterns motivate the proposal that these non-reflexive non-argumental clitic pronouns of Spanish are complements of a null directional-like preposition. I lay out this proposal in detail in the next section.

3. The Null Directional-like Preposition

Based on the parallel patterns observed between goal prepositional phrases and reflexive pronoun constructions, MacDonald (2004) proposes that the reflexive non-argumental clitic pronoun of Spanish is introduced as the complement of a null preposition that has properties of a goal preposition; i.e. a goal-like preposition. In a similar vein, I argue that the non-reflexive non-argumental clitic pronoun of Spanish is introduced as the complement of a null preposition that has properties of a directional preposition; i.e. a directional-like preposition. This proposal straightforwardly explains the properties outlined in section 2 (i.e. the inability to delimit the event, and the lack of *on/with* entailment); they result from the nature of the null preposition. I assume that this null preposition merges as a complement of the verb resulting in a structure as in (14).

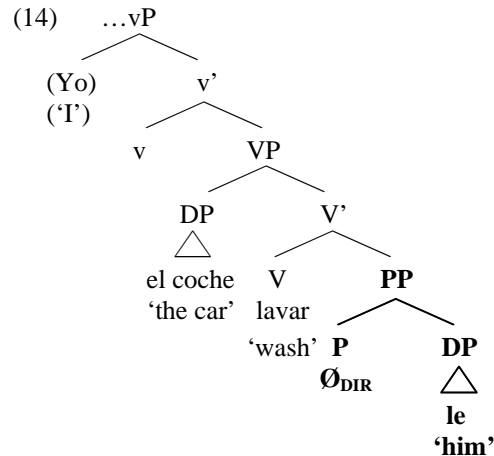

I assume that the verb together with the prepositional phrase assigns a compositional theta-role to the internal argument (Larson 1988), which determines the permissible range of relations between the direct object and the denotation of the non-reflexive (e.g. temporary relations). The clitic then undergoes clitic movement and the derivation proceeds normally.

Indirect support for the low merger of the null preposition comes from *do-so* constructions. Directional prepositional phrases are odd in *do-so* constructions (15a), especially when compared to location prepositional phrases (15b).

- (15) a. ??Ralph pushed the car **towards** the church
and Frank did so **toward** the school.
- b. Ralph played soccer **at** the church
and Frank did so **at** the school.

These data suggest that directional prepositional phrases are not adjoined to vP, but merge lower in the structure. Maintaining the parallels between the overt directional prepositional phrase and the null directional-like prepositional phrase, I assume that the null directional-like prepositional phrase has the same configuration as the overt directional prepositional phrase. As such, I take these *do-so* data as indirect support for the structure in (14) in which the null directional-like prepositional phrase merges as a complement of the verb.

3.1 Adjectival secondary predication

As noted above, non-reflexives of Spanish resist adjectival secondary predication. The data that illustrates this fact is repeated below in (16) for convenience.

- (16) Yo_j **le**_k lavé el coche borracho_{j/*k}.
 I_j **to-him**_k washed the car drunk_{j/*k}.
 'I washed **his** car drunk.' or 'I washed the car **on/for him** drunk.'

Observe that the resistance to adjectival secondary predication is not a result of the clitic status of the non-reflexive pronoun, as **argumental** clitics can be modified by adjectival secondary predicates, as shown in (17).

- (17) Juan **la**_k besó borracha_k.
 Juan **her**_k kissed drunk_k.
 'Juan kissed **her**_k drunk_k.'

Adopting the analysis of adjectival secondary predication of Bowers (2000), the fact that the null directional prepositional phrase merges as a complement of the verb explains the resistance to adjectival secondary predication. Bowers claims that secondary predicates are V' adjuncts that contain a PRO in their specifier. In order to establish a predication relation, a DP must control PRO. Given that the null directional-like prepositional phrase merges as a complement of the verb, it merges lower than the secondary predicate and, as such, the non-reflexive cannot control PRO. Thus, no predication relation can be established between a non-reflexive non-argumental clitic of Spanish and a secondary predicate.

As expected, complements of overt directional prepositions also resist adjectival secondary predication. This expectation is shown in (18).

- (18) Ralph_j threw the ball **toward Frank**_k drunk_{j/*k}.

Thus, given the proposal by Bowers (2000), the lack of adjectival secondary predication results transparently from the low merger of the null directional-like prepositional phrase. To put it another way, the lack of adjectival secondary predication supports the low merger of the null directional-like prepositional phrase.²

3.2 Idiom prevention

Idioms are assumed to enter into the syntax as units. In order to prevent idiomatic interpretation from surfacing, a syntactic element must merge locally to the idiom unit. Given the low merger of the null prepositional phrase, we expect that non-reflexives can prevent idiomatic interpretation. This was shown in (4) above. I repeat the data below in (19) for convenience.

- (19)a. Juana bebe los vientos por Javier.
 Juana drinks the winds for Javier
 Idiomatic meaning: 'Juana is in love with Javier.'

- b. #Juana **me** bebe los vientos por Javier.
 Intended meaning: 'Juana is in love with Javier **on me**.'

It follows straightforwardly from the low merger of the null directional-like prepositional phrase that the presence of the non-reflexive can prevent idiomatic interpretation. It merges locally to the idiom unit and can break it up. Note moreover, as expected, overt directional prepositions can also prevent idiomatic interpretation (20).

- (20) #John spilled the beans **toward** the police.

3.3 Recap

I have argued that the non-reflexive non-argumental clitic pronoun of Spanish is introduced as the complement of a null directional-like preposition that merges as the complement of the verb. Given the low merger of this null prepositional phrase, previously unexplained facts surrounding the presence of the non-reflexive are straightforwardly explained. Resistance to adjectival secondary predication results from the null prepositional phrase merging lower than the secondary predicate, and the ability to prevent idiomatic interpretation results from the null prepositional phrase merging locally to the idiom unit and being in a configuration to break it up. Furthermore, three properties surrounding the non-reflexive construction have been argued to be a result of the nature of the null preposition that introduces the non-reflexive; namely, the inability to elicit a telic interpretation of the predicate, the inability to express *on/with* entailment, and the ability to express temporary relations. These properties were made salient by a contrast with constructions containing reflexive non-argumental pronouns of Spanish. In the next section, we turn to another contrast between reflexives and non-reflexives.

4. Variation in the Prevention of Idiomatic Interpretation

There is a curious, and previously unnoticed, variation in the prevention of idiomatic interpretation in Spanish that is contingent on the type of non-argumental clitic pronoun present with the idiom. Observe the idiom in (21); the idiomatic portion is underlined.

- (21) a. Sin PRO_i comer(se_i)lo ni beber(se_i)lo Inés_j recibió un puñetazo.
 without PRO_i eat(**herself_i**)it nor drink(**herself_i**)it Inés_j got a punch
 'Without PRO_i deserving it, Inés_j received a punch.'

- b. #Sin PRO_i comer_klo ni beber_klo Inés_j recibió un puñetazo.
 without PRO_i eat.to-me_kit nor drink.to-me_kit Inés_j got a punch
 ‘Without PRO_i deserving it, Inés_j received a punch (on me_k).’

In the presence of the reflexive pronoun (21a), there is no loss of idiomatic interpretation.³ However, in the presence of the non-reflexive the idiomatic interpretation is lost (21b). These facts provide a means of better understanding the range of relations expressible by the non-reflexive.⁴

I have argued that the non-reflexive has the underlying structure given in (14) above in which it is introduced as the complement of a null directional-like preposition. MacDonald (2004) argues that the reflexive pronoun has essentially the same underlying configuration as the non-reflexive pronoun structure in (14), except that the null preposition introducing the reflexive is goal-like in nature. Thus, given the parallel syntactic configurations of both the reflexive and the non-reflexive constructions, it is difficult to appeal to their underlying structure to explain the variation in ability to prevent idiomatic interpretation, as observed in (21). Given that the only difference between these constructions lies in the nature of the null preposition taking each pronoun, we expect this variation to result from the different properties of these distinct null prepositions.

Nunberg et al. (1994) offer a way of understanding how the different properties of these null heads can affect idiomatic interpretation. They claim that idioms can have parts, and that these parts can be modified.⁵ If modification is consistent with idiomatic meaning, then there will be no loss of idiomatic interpretation. If modification is inconsistent with the idiomatic meaning, then there will be a loss of idiomatic interpretation. Let us take a closer look at the idiom in question and unpack its parts.

The idiom in (21) expresses that there is some object *lo* ‘it’ received by some individual that does not deserve it. Thus, there are two parts to the idiom: **1.** The object received (*lo*), and **2.** The individual who receives the object (who happens not to deserve it). The receiver of the object controls PRO, and the object comes into the possession of the controller of PRO. Crucially, in order to express this idiom, as a minimal requirement on the idiom’s use, the object must be understood to have come into the possession of the controller of PRO.⁶ In the example in (21), the object is a punch, and Inés receives it. Inés is the controller of PRO.

Let us examine the affect of the addition of the reflexive on this idiom. As shown in (21a), Inés controls PRO. Inés also binds the reflexive. One of the properties stemming from the nature of the null goal-like preposition introducing the reflexive is expressed by an *on/with* entailment; i.e. the direct object is interpreted as *on/with* the denotation of the reflexive (see section 2). In (21a), the reflexive expresses that *lo* ‘it’ is *on/with* Inés. This is precisely what the idiom itself must crucially express, that the object come into the possession of

the receiver (i.e. Inés). Thus, the addition of the reflexive modifies part of the idiom in a way that is consistent with the meaning of the idiom, and idiomatic interpretation is not lost.

Let us examine the affect of the addition of the non-reflexive on this idiom. Crucially the denotation of the non-reflexive is not Inés, not the individual that receives the object. In virtue of what the idiom expresses, Inés must be in receipt of the object, of *lo*. Given that Inés and the non-reflexive denote distinct individuals, the idiom containing the non-reflexive expresses that *lo* is related to distinct individuals: Inés and the denotation of the non-reflexive. This seems to be the reason why idiomatic interpretation is lost in the presence of the non-reflexive. That is, the object must have come into the possession of Inés in order for her not to deserve it; yet, the presence of the non-reflexive expresses that there is a relation between the individual denoted by the non-reflexive and *lo*. If there is a relation between the denotation of the non-reflexive and *lo*, then it seems that *lo* cannot have been understood to have come into the possession of Inés. If *lo* cannot be understood to have come into the possession of Inés when the non-reflexive is present, then the non-reflexive modifies part of the idiom in a way inconsistent with the idiomatic meaning, and idiomatic interpretation is lost.

Observe another way to understand the ungrammaticality of the idiom in the presence of the non-reflexive in (21b). Let us assume that *lo* has come into Inés's possession, satisfying the minimal requirements on the use of the idiom. In this case, it appears that the source of the ungrammaticality in (21b) must arise from the inability of the non-reflexive to express a relation between the individual denoted by the non-reflexive and an object (already) related to some other individual; *lo* is already related to Inés in virtue of *lo* having come into her possession. In this case, the non-reflexive cannot be used to express any type of relation at all that may exist between *lo* and the individual denoted by the non-reflexive.

A non-idiomatic construction serves to make this constraint of the non-reflexive more salient (22).

- (22) *Juan **me** bebió la cerveza.
 Juan **to-me** drank the beer
 'Juan drank my beer.'

In a context in which I make beer, bottle it and then sell it to Juan, when Juan is later in his home drinking the beer, I cannot use the non-reflexive to express that Juan drank my beer (22). I cannot use the non-reflexive to express any relation I might have had, or still have with the beer. Contrast the non-reflexive with the genitive possessor, which can express this type of relation (23).⁷

- (23) Juan bebió **mi** cerveza.
 Juan drank **my** beer
 ‘Juan drank my beer.’

It seems that once a relation is established by some contextually salient means between an object and some individual not denoted by the non-reflexive, a relation between that same object and the denotation of the non-reflexive cannot be expressed using the non-reflexive. This is precisely the situation described above in the idiom in (21). An object (i.e. *lo*) is related to an individual (Inés) in virtue of the idiom itself, and therefore, even if there were some relation between the individual denoted by the non-reflexive and that same object, the non-reflexive could be used to express it.

The variation in the ability to prevent idiomatic interpretation observed in (21) is contingent on the type of non-argumental clitic pronoun that is present with the idiom. The non-reflexive prevents idiomatic interpretation and the reflexive does not. I have suggested that this variation is a result of the distinct properties of the null prepositions that introduce these non-argumental clitics. Furthermore, we observed that in a context in which some object was contextually associated with an individual other than the one denoted by the non-reflexive, any type of relation between the individual denoted by the non-reflexive and that object could not be expressed using the non-reflexive. This affords a greater understanding of the range of relations expressible by the non-reflexive.

5. Conclusion

I have argued that the non-reflexive non-argumental clitic pronoun of Spanish is introduced as a complement of a null directional-like preposition that merges as a complement of the verb. This hypothesis straightforwardly explains a range of properties shared between these non-reflexive constructions and constructions containing an overt directional preposition; they result from the nature of the null directional-like preposition taking the non-reflexive as its complement.

Notes

1. In fact, to account for these facts formally, MacDonald (2004) argues that this reflexive pronoun of Spanish is introduced as the complement of a null **goal-like** preposition.
2. Another analysis of adjectival secondary predication is offered by Demonte (1988). She argues that predication results from mutual c-command. If her analysis is correct, then this is an argument for the existence of the null prepositional phrase itself; for the presence of the maximal projection of the null prepositional phrase blocks the non-reflexive from c-commanding out and c-commanding another XP.
3. Observe that reflexives **can** prevent idiomatic interpretation though: #*Juana se bebe los vientos por Javier*, literally ‘Juana herself drank the winds for Javier.’, meaning Juana is in love with Javier. This fact about reflexives is observed in de Miguel & Fernández Lagunilla (2000) and

MacDonald (2004). The prevention of idiomatic interpretation by the reflexive can be argued to result from the nature of the null preposition introducing the reflexive, and its inability to modify part of the idiomatic meaning. See Nunberg et al. (1994) for more details on the ability to modify idiom parts.

4. Observe that in (21a) the accent written over *comér(se)lo* is only required when the reflexive is present. It is not required if no reflexive is present.
5. Nunberg et al. (1994) claim that not all idioms have parts. Those that do are termed *idiomatic combining expressions*, and those that do not are called *phrasal idioms*. The idiom in (21) patterns with an idiomatic combining expressions.
6. It should be noted that there seems to be some ambiguity with respect to the interpretation of the denotation of *lo* in this idiom. Some speakers take *lo* to denote an object that has come into the possession of an individual. However, some people take *lo* to denote the entire event experienced by that individual. For those who take *lo* to denote the event experienced, in (21) the event would be *the receipt of a punch*. This ambiguity has consequences for the licensing of this idiom. Observe that in (i-ii) there is no object that has come into the possession of Inés. Thus, for native speakers that take *lo* to refer to an object received, the idiom is not licensed here. For native speakers that take *lo* to refer to the entire event experienced, the idiom is licensed here. i) *Sin comerlo ni beberlo, (ellos) me engañaron*. 'Without me deserving it, they cheated me.' ii) *Sin comerlo no beberlo, (ellos) le robaron el coche a Inés*. 'Without her deserving it, they stole Inés car.'
7. The genitive possessor is able to express this type of relation (23). This suggests that the genitive possessor can express a wider range of relations than the non-reflexive. Moreover, recall from section 2 that the non-reflexive can express temporary relations while the reflexive cannot. This suggests that the non-reflexive can express a wider range of relations than the reflexive. A hierarchy of expressible relations seems to emerge. The reflexive seems to express the most restricted range of relations, the non-reflexive seems to be able to express a wider range, and the genitive possessor seems to be able to express the widest range of relations.

References

- Bowers, John. 2000. 'Predication' In M. Baltin & C. Collins (eds.) *The Handbook of Contemporary Syntactic Theory*. Blackwell: Malden: 299-333
- de Miguel, Elena and Marina Fernández Lagunilla. 2000. 'El operador aspectual *se*', *Revista Española de Lingüística*, 30.1: 13-43
- Demonte, Violeta. 1988. 'Remarks on Secondary Predicates: C-command, Extraction, and Reanalysis' *The Linguistic Review*, 6:1-39
- Dowty, David. 1979. *Word Meaning and Montague Grammar*. Dordrecht: Reidel.
- Larson, Richard K. 1988. 'On the Double Object Construction', *Linguistic Inquiry*, 19.3: 335-391.
- MacDonald, Jonathan E. 2004. 'Spanish Reflexive Pronouns: a Null Preposition Hypothesis', In G. Garding & M. Tsujimura (eds.) *Proceedings of WCCFL 23*. Somerville, MA: Cascadilla.
- Nishida, Chiyo. 1994. 'The Spanish reflexive clitic *se* as an aspectual class marker', *Linguistics*, 32: 425-458.
- Nunberg, Geoffrey, Ivan A. Sag and Thomas Wasow. 1994. 'Idioms', *Language*, 70.3: 491-538
- Pustejovsky, James. 1991. 'The syntax of event structure', *Cognition*, 41: 47-81.
- Sanz, Montserrat. 2000. *Events and Predication: A New Approach to Syntactic Processing in English and Spanish*. Amsterdam: John Benjamins.
- Tenny, Carol. 1994. *Aspectual Roles and the syntax-semantics interface*. Dordrecht: Kluwer.

Zagona, Karen. 1994. 'Compositionality of Aspect: Evidence from Spanish Aspectual Se', In C. Parodi, C. Quicoli, M. Saltarelli, and M.L. Zubizarreta (eds). *Aspects of Romance Linguistics*, Washington DC: Georgetown UP.

Jonathan E. MacDonald
Stony Brook University
macdonald.jon@gmail.com

Non-canonical A-Positions & Possession¹

Andrew Gordon Middleton

Université de Montréal

1. Introduction

This paper is an investigation of what interpretative effect can be attributed to markedness and contrast between lexically similar syntactic constructions². I assume that certain forms and phrases can be considered *marked* or *non-canonical* versions of more statistically common forms and phrases; when these contrast with their *canonical* forms their interpretation is subject to a range of readings that is not available to them when in their more statistically common positions. I present this as an alternative to the theoretical framework pursued by Rizzi (1997) (among others) that allows a variety of ‘projections’ in a ‘left periphery’ to account for certain subtleties of meaning not directly explainable by lexical content. I argue that the interpretation these arguments are subject to in these positions is not due to ‘raising’ to certain ‘nodes’ but simply that, by being marked forms, they are susceptible to a higher degree of pragmatic conditioning than when the same arguments are found in their canonical positions. Among marked interpretations associated with such marked positions are topicalization, focus and illocutionary force. I investigate the idea that the syntax resulting in possession is such an interpretation and not a direct result of a discrete function of the grammar such as genitive case or a particular possession ‘operator’ or morpheme. Instead, possession is a secondary effect resulting from a canonical/non-canonical alternation in tandem with the appropriate pragmatic conditions. I further propose that the English double object construction is particular as an example of such an alternation and that any reading it has that contrasts with an NP+PP construction containing the same lexical content is distinct for this reason.

This research is part of a larger project examining the empirical basis of certain core assumptions of Generative Grammar; nonetheless, wherever possible I have avoided introducing new terminology and maintained most terms used in Generative Grammar. The terms *canonical* or *non-canonical* argument position, although analogous to the Generativist principles of A- and A' positions, are significantly different and warrant some explanation. The notion of ‘logical argument position’ seems without empirical basis, resulting from the nature of the problem and stochastic norms; as such I consider ‘speaker judgement’ tasks as being exercises in recalling any stochastic conditioning (or the lack) rather than any presumed ‘parameter setting’ assumed under Principle and Parameters theory. The terms used

here pertain only to whether or not an NP is in a ‘canonical’ relation to a verb, or not. That is, I presume no innate linguistic structure but consider the distinction of whether or not an NP is in its language *typical* argument position to be critical for pragmatic effects on interpretation. That is to say, this is an investigation of the assumption that word order directly affects meaning without assuming the innatist hypothesis.

1.1 Background

Possession is usually associated with genitive case but the role of this case is poorly understood. Although genitive case was at one point considered a problematic inherent case (Chomsky (1986) and references within), its lack of association with a specific thematic role (or *theta* role), a general trait of inherent cases) has led others to propose that it is a structural case necessary where there are two NPs within a determiner phrase (DP) (Valois (1991) and references within). Among the questions that this account raises is the fact that a purely structural explanation (including assumptions that the case marker is only to ‘licence’ the NP) ignores the widespread understanding that genitive case implies a relation between two NPs in a DP—often that of possession. When compared with the findings of Beck and Johnson (2004) (henceforth B&J; see also, e.g. Harley (1995) and references within), who claim that there is a semantics of possession in the English Double Object Construction (henceforth DOC), we must more closely examine what role (if any) genitive case contributes to possession constructions.

Following Kayne (1984b), B&J propose that the DOC is comprised of a HAVEP small clause (headed by a phonologically null HAVE operator/morpheme (HAVE⁰) that both acts as the head of the small clause (henceforth SC) and imparts the possessive meaning absent from lexically similar NP+PP constructions)). Understanding what environments or preconditions give rise to possessive readings, even in the absence of any particular syntactic form or lexical item that consistently communicates possession, may reward investigation. If there are seemingly different syntactic forms that give rise to the same or similar readings (while being very prone to pragmatic interference), we might examine what is common to each form, i.e. what causes different forms to produce the same effects. A direct comparison of possessive double object constructions with genitive possessive constructions gives rise to several possible ways to account for the possession reading. Are the agents for the possessive reading the same, i.e. is there something like B&J’s HAVEP found in instances of possession with genitive case or is there some other mechanism of possession (such as a covert ‘genitive’ case) in the DOC? An alternative explanation is that whatever condition allows possession readings in genitive marked phrases also allows it in the DOC. The hypothesis that a null operator exists in both structures requires empirical proof but there seems little evidence to support this; furthermore there is little reason to suppose that

any evidence could be taken to support this simply because both these structures (DOC and genitive DPs) are found without the possessive meaning. If the possession reading were communicated by a discrete element (such as HAVEP or Poss⁰) then we would need to find the null operator in all instances of the genitive and double object constructions. We would hope to find it in both constructions and only in the instances when these constructions communicate possession. I therefore consider what environmental conditions might function as preconditions for the possession reading and are common to both the DOC and genitive DPs.

In considering the effects of non-canonical positions as determined by the verb, I offer an explanation for the ‘small clause’ failure of extraction facts in the double object construction as well as for the accompanying possession reading.

1.2 Relation to the Verb/Event

As a further question, if we accept ‘our’ and ‘my’ as genitive case pronouns, we have to ask what exactly this means and how they differ from their nominative and accusative equivalents. I pursue the idea that, aside from implying possession, they mark a productive alternation whereby a canonically sequenced NP—e.g., a topic subject—can appear in a non-canonical position and consequently an instrumental serves as the topic and the topic acts as something like a patient, as in (1).

- (1) a. i. I showed that they were doomed
 ii. My discussion showed that they were doomed
 b. i. I left precisely because of that remark
 ii. My leaving was precisely because of that remark

It is just this sort of alternation that allows for the possession reading in both phrases with genitive case and the DOC.

To be clear, this canonical/non-canonical alternation cannot trigger such a possession reading because there are such alternations that do not imply possession—just as not all genitive or DOCs imply possession. Instead, this alternation is a *precondition* for possession just as it is for other effects associated with the ‘left periphery’. That is, I suggest that this alternation makes the phrase more open to pragmatic interpretations and other secondary effects.

At this point, we need to understand if the DOC can be analyzed as a similar canonical/non-canonical alternation. What is common to both these forms is that the NP in question is not in its typical position in relation to the verb.

1.3 Defining my Possession

According to my view, the syntactic forms associated with possession are semantically meaningful only in that they imply a relation between two NPs. For the

purposes of the present discussion, I assume that there is no substantive syntactic difference between genitive constructions that confer possession and those that do not. While phrases such as “my watch” or “my boss” can be understood variably as possession or simply as a permanent or temporary relation between two things, the reading seems to be more conditioned by pragmatics and the logic of the situation rather than other elements in the phrases³. In the sentence, “My professor sent Lynn David’s notes to yesterday’s lecture”, one could argue that there are up to four possession readings or possibly none at all. We have no possession readings if the following are true: I cannot possess my professor; the possession inferred by the double object construction is undermined because Lynn never received the notes; David is only the author of the notes (and thought he had destroyed the last copy); yesterday is ineligible to possess anything. In examples, such as “yesterday’s lecture” and “Bailey’s time with us”, it could be argued that in some way there is a possessor and possessed; nonetheless, such possibly forced interpretations are ultimately unhelpful if we want to understand how and to what extent human syntax is a compositional system.

2. Transforming Arguments?

Many investigators, notably Larson (1988), have considered the possibility that sentences of the form in (2a) must be somehow transformationally derived from sentences of the form in (2b).

- (2) a. Catie sent Karina the 13 meg attachment
- b. Catie sent the 13 meg attachment to Karina

The idea of a possible NP+PP to double object (DO) transformation is appealing, partly because we know that when a verb licenses one form, it often licenses the other (see also Jackendoff (1990) for discussion). From this, the common idea is that these are only different surface manifestations of the same underlying form. A prevalent view is that the NP+PP is thought to be underlying and the double object derived.

Green (1974) points out that these differences form a pattern. She says that the double object construction always has a meaning component not always found in the corresponding NP+PP sentence, something like possession.

2.1 Teasing out the subtle ‘Have’ relation

Following Kayne (1984b), who proposed that the double object construction contains a small clause, B&J propose that the double object construction is comprised of a HAVEP small clause headed by a phonologically null HAVE⁰ that both acts as the head of the small clause and imparts the possessive meaning absent from lexically similar NP+PP constructions. Their structure is as in (3).

- (3) a. $[\bar{V} [V^0] [_{VP} [_{NP} \text{the 13 meg attachment}] [\bar{V} [V^0 \text{ sent}] [_{PP} \text{to Karina}]]]]]$
 b. $[_{VP} \text{Catie}] [\bar{V} [V^0] [_{VP} [V \text{ sent}] [_{HAVEP} [_{NP} \text{Karina}] [\overline{HAVE} [_{HAVE^0}] [_{NP} \text{the 13 meg attachment}]]]]]]]$

In contrast to this representational view of a preexisting grammatical structure, I propose that the surface realization is a result of tensions resulting from the canonical/non-canonical alternation possible in a ‘derivation-by-chunks’ arrangement⁴. Here, the first NP in the DOC, by being in a marked argument position, is open to interpretations not otherwise available (perhaps conditioned by the logic of the situation or pragmatic effects). Due to the nature of the verbs in question, these pragmatic effects centre on such readings as possession (whether or not this is material or abstract possession, i.e. the possession might be understood in a ‘legal’ rather than material sense in some cases⁵) and aspectual closure.

There is a stronger HAVE reading in the DOC in cases such as (4) where we have a P⁰ such as ‘for’ as opposed to (2a) that has the P⁰ ‘to’.

- (4) a. Jonathan cooked dinner for Benjamin
 b. Jonathan cooked Benjamin dinner

According to principles of semantic decomposition, this is unexpected. I suggest that this is a question for investigation, not a mere curiosity, and that it is significant for the proposal that pragmatics might be effecting this meaning in the sense that we are not considering a simple, binary alternation. If an element such as HAVE⁰ were necessary for the double object form, we would have little variation in meaning relating to this construction; instead we have fairly subtle readings that a hypothesis relegating possession to pragmatics might explain. I speculate that perhaps what causes the difference between (2a) with ‘to’ and (4) with ‘for’ is partly the loss of the more semantically contentful preposition (in this case, ‘for’). I suggest that any contrast with canonical positions is more important than the particular configuration of the syntax.

2.2 Nominalizations

In this section, I review B&J’s evidence for a small clause analysis and present an alternate interpretation of the same facts.

Generally, nominal forms of verbs can combine with the object of a verb either inside an *of*-phrase or as a genitive as in (5).

- (5) a. construct the ditty
 b. the construction of the ditty
 c. the ditty’s construction

If the object does not logically combine with the verb, this fails. This indicates that the apparent direct object is not the logical object or argument of the verb. (Of course not all lexical items are open to such alternations, or at least not with consistent meanings; e.g. ‘the love of Catie’ is not necessarily equivalent to ‘Catie’s love’.) This is notably the case if the ‘object’ is instead the subject of a small clause (original paradigm from Ross (1974)). Contrasting with (5) is (6), a standard small clause.

- (6) a. believe Catie crazy
 b. * the belief of Catie crazy
 c. * Catie’s belief crazy

B&J review Kayne’s argument that DOCs are small clauses because they prevent this same type of extraction and behave more like ‘believe’ or ‘consider’ than verbs such as ‘construct’ or ‘examine’. This is illustrated in (7).

- (7) a. present Catie the snail
 b. * the presentation of Catie of the snail
 c. * Catie’s presentation of the snail

This contrasts very clearly with the very same verb in the NP+PP form, as in (8).

- (8) a. present the snail to Catie
 b. the presentation of the snail to Catie
 c. the snail’s presentation to Catie

B&J claim that the second NP of the double object construction also fails this test. They say that it fails to passivize or object-shift past particles, two characteristics of objects. B&J conclude that, failing this test, the conventional perception that the second NP in the DOC is an argument of the verb is wrong. Unfortunately, they do not investigate other means of testing this hypothesis. They do not question whether perhaps this shows a limit of their test or whether there are other complicating factors inhibiting comprehension. In short, they do not show convincingly that the DOC contains an SC.

2.3 Extraction from the marked position

B&J cite one other syntactic phenomenon to show that the first NP in the double object form has a different status than the first NP in the NP+PP form. Extractions (or more accurately, subextractions if we want to account for dialectal variations between North American and European English) in (9) show that the double object NP₁ prevents extraction in a way that the NP₁ of the NP+PP form does not.

- (9) a. Who_i did you send (a friend of) *t_i* to the doctor?
 b. Who_i did you send (a friend of) Sarah to *t_i*?
 c. Who_i did you send (*a friend of) *t_i* a book?
 d. What company_i did you send (?*an employee of) *t_i* an envelope?

This is predicted under B&J's—and Kayne's—assumption that the double object construction is a small clause because, according to their argument, small clauses normally do not permit extraction. The question remains, however, *why* a subject of a small clause should resist or not permit extraction. To state it as a typological phenomenon without inquiring into the cause of the typology is to accept it as an arbitrary stipulation of the grammar. Furthermore, the grammatical version of (9c) is not explained under B&J's account; I suggest that this points to issues of processing difficulty among other possible problems and is more a problem of *subextraction* than extraction *per se*; the reason that both (9a) and (9b) are more grammatical than (9c) (and that even (9d) is more grammatical than (9c)) might be explained by examining the question of parsing because it can be argued that the preposition eases parsing difficulties⁶.

The empirical extraction failure facts need to be accounted for by something more than the claim that a small clause does not permit extraction from its subject position. I suggest that the failure to extract from the double object construction follows from my hypothesis that the double object construction is an alternation of the NP+PP form and that the second NP ([_{PP} NP]) of this form has undergone contrastive displacement or at least *is* contrastive as regards the speaker's judgement repertoire. Additional extraction from the derived position increases computational difficulty and is thus ungrammatical for some speakers.

Comparisons with Heavy NP Shift (HNPS) here is possibly informative. In an example such as (10), extraction out of a constituent that has undergone something like HNPS is similarly awkward to extraction out of the NP₁ of the DOC.

- (10) a. I saw a picture of Bailey yesterday
 b. Who did you see a picture of yesterday
 c. I saw, yesterday, a picture of Bailey
 d. ?? Who did you, yesterday, see a picture of?

If the double object alternation is some kind of stylistic inversion, awkwardness of extraction similar to HNPS is unsurprising: in both cases, entering into these non-canonical positions is already a marked position, and perhaps it is problematic to parse arguments that have passed through one such position only to undergo subextraction of a component of it⁷. That is, while there may be no blocking element preventing such a movement, for ease of parsing this would be a marked derivation, possibly to the point that it results in unacceptability for a

speaker. Supporting this characterization is the fact that European English does not have the same injunction against fronting the DOC's NP₁ as well as the discovery of a group of New York City speakers by Kurtzman (1989) for whom extraction of the indirect object from the DOC is acceptable both in terms of production and comprehension. That these extractions nonetheless cause processing difficulties for listeners suggests that this might be why it is avoided in some populations and considered 'ungrammatical'.

The degree of ungrammaticality of the extraction tests in (11), which included relativization, topicalization and the cleft construction, is similar to those in (10). If the cleft construction is a canonical/non-canonical alternation, we might expect an accompanying difficulty in parsing items subextracted from this marked position and the attested awkwardness.

- (11) a. i. It's Catie I gave the book to
 ii. ?? It's Catie I gave the book
 b. i. That's the friend_i that I sent the book to *t_i*
 ii. ?? That's the friend_i that I sent *t_i* the book (cf. "I sent the friend the book")

3. So Where Does Possession Come From?

With the canonical/non-canonical alternation and the impossibility of forming a constituent in English without formally acknowledging the conjunction, we can look at the English sentence in (12).

- (12) Lynn's dog bit the mailman

Here 'Lynn' has no role in biting the mailman (i.e. in the event in question) yet, by being 'mentioned' in this way, she is connected to an element that *is* in the event structure. I suggest that the possession readings can be explained by investigating the relation of the [_{NP} Lynn] to the verb or event.

The possession readings available with the genitive and the double object, at the most general level, can be correlated by considering marked positions at the event level⁸. Regardless of other possible functions, it seems from this that genitive case may be a marker of the special status of the genitive marked NP. Evaluating whether or not a referent has a direct or indirect relation to the *event* (or state) expressed by the relevant clause may help us better understand the effect of these marked positions. In the case of the genitive marked DP, in a sentence such as (12), the 'Lynn' in question is only referred to indirectly and is not implied to have any *direct* relation to the event.

4. Conclusion

I have attempted to provide a non-stipulative reason why the double object construction and the genitive DP can result in similar readings. This would answer the questions posed by the small clause characteristics (both in terms of extraction and in terms of the semantics) without the need of such phonologically null elements as HAVE⁰. That extraction from the NP₁ of the double object construction is problematic may be due to added difficulty in parsing multiply extracted (or subextracted) elements (i.e. from marked non-canonical positions that are not part of any possible reconstruction—or ‘chain formations’). It also would explain why, in both genitive constructions and double object constructions, the possession reading is so prey to pragmatic interpretation.

I have used the constructions of the English genitive and double object construction to challenge the assumption that there exists a discrete element in the grammar that communicates semantics such as what we understand to be possession. Instead, I have suggested that possession is a result of a the greater possibility of pragmatic conditioning of arguments outside of their canonical argument positions (perhaps similar to Gricean Implicature) and that we can only expect to find the correct syntactic *preconditions*, not operators. I have introduced the idea that the first NP in the English double object construction and the genitive marked NP both allow for a ‘possession’ interpretation because they are both in non-canonical positions. As such, they—like elements in the so-called ‘left periphery’—are susceptible to a much greater degree of pragmatic affectedness than NPs that are in language typical positions. Finally, I have suggested a possible non-stipulative reason for the failure of extraction from the NP₁ of the double object construction.

Notes

- ¹I would like to thank to Daniel Valois, Christine Tellier, Jon Nissenbaum and Kyle Johnson for valuable discussion; I would also like to thank Heidi Harley, Hajime Hoji, Lisa Travis, Tim Stowell, Jean Roger Vergnaud, Maria Luisa Zubizarreta and the audience at WECOL 2004 (USC) for their insights and comments. I would like to give a special thanks my language informants Raphael Mercado, Hanna Outakoski, Katarzyna Raczka, Adam Szczegieliak, Kathryn Tippetts for their judgements and comments as well as the organizers of WECOL 2004 at USC for all their help and patience. Finally I would like to thank Catie and my family for their support. All errors and biases are my own.
- ²As regards their relation to the event. I do not offer an explicit definition as to how this relation is defined and doubt that a satisfactory one can be determined with our current understanding of word storage and association.
- ³See for instance: The Det Rule (Williams, 1982, 283): “The relation between the possessive NP and the following \bar{N} can be any relation at all” cf. Barker (1991) for an opposing viewpoint.
- ⁴The details of which are beyond the limits of this paper.
- ⁵Thanks to Heidi Harley (personal communication) for this analogy.
- ⁶Alternately, on a structuralist view, following Kayne (1984a)’s Connectedness Condition, the subextraction is addressed, though this still does not address issues of dialectical variation or the apparent differences in (9c) and (9d).
- ⁷Nonetheless, there are cases of subextraction from elements in analogous A’-positions, originally discussed in Torrego (1985) and subsequently in Chomsky (1986).

⁸That the facts pertaining to the canonical/non-canonical distinction at the nominal level are slightly different in languages other than English should not be a problem for this account because I confine my prediction to arguments at the event level.

References

- Barker, Chris. 1991. Possessive descriptions. Doctoral Dissertation, University of California, Santa Cruz.
- Beck, Sigrid, and Kyle Johnson. 2004. 'Double objects again'. *Linguistic Inquiry*, **35**, 1:97–123.
- Chomsky, Noam. 1981. *Lectures on government and binding*. Dordrecht, The Netherlands: Foris Publications.
- Chomsky, Noam. 1986. *Barriers*. Cambridge, Mass.: MIT Press.
- Green, Georgia M. 1974. *Semantics and syntactic regularity*. Bloomington, Indiana: Indiana University Press.
- Harley, Heidi. 1995. Subjects, events and licensing. Doctoral Dissertation, Massachusetts Institute of Technology.
- Jackendoff, Ray. 1990. 'On Larson's treatment of the double object construction'. *Linguistic Inquiry*, **21**, 3:427–455.
- Kayne, Richard S. 1984a. *Connectedness and binary branching*. Dordrecht, Holland: Foris Publications.
- Kayne, Richard S. 1984b. 'Unambiguous paths'. In *Connectedness and binary branching*, 129–164. Dordrecht: Foris Publications.
- Kurtzman, Howard S. 1989. Extraction of indirect objects. In *Proceedings of ESCOL VI*, 173–181. Department of Linguistics, Ohio State University, Columbus.
- Larson, Richard. 1988. 'On the double object construction'. *Linguistic Inquiry*, **19**, 3:335–392.
- Rizzi, Luigi. 1997. 'The fine structure of the left periphery'. In *Elements of grammar*, ed. Liliane Haegeman, 281–337. Dordrecht: Kluwer.
- Ross, John. 1974. 'Nouniness'. In *Three dimensions of linguistic theory*, ed. O. Fujimura, 137–257. Tokyo: TEC Corporation.
- Torrego, Esther. 1985. 'On empty categories in nominals'. Ms. University of Massachusetts, Boston.
- Valois, Daniel. 1991. The internal syntax of DP. Doctoral Dissertation, University of California, Los Angeles.
- Williams, Edwin S. 1982. 'The NP cycle'. *Linguistic Inquiry*, **13**, 1:277–295.

Andrew Gordon Middleton
 Université de Montréal
 andrew.middleton@v11.org

Emergent Features: Evidence from Natural Classes in 561 Languages

Jeff Mielke¹

University of Arizona

1. Introduction

It is widely known that some sound patterns involve “unnatural classes” which are not easily described using generally-accepted distinctive features. A well-known case is the “ruki” rule in Sanskrit (Whitney 1960), whereby /s/ is retroflex when it follows any member of the set /r u k i/, and nonretroflex elsewhere.

While it is widely accepted that unnatural classes such as this do exist, it is not widely known how widespread unnatural classes actually are. A tacit assumption that unnatural classes are rare has facilitated their marginalization by phonological theory. This paper will overview a crosslinguistic survey of natural (and unnatural) classes, and discuss how these classes would be expected to behave if features are innate (i.e. emergent in biological evolution) or if features are emergent from other external factors. Finally these predictions will be tested, and an account will be sketched based on the results.

2. A Crosslinguistic Survey

The purpose of the survey (described in more detail in Mielke 2004) is to collect a large sample of classes of segments involved in sound patterns, and to determine how many are predicted by innate features. The object of the survey is the phonologically active class, defined as in (1).

- (1) Phonologically active class: any group of sounds which, to the exclusion of all other sounds in a given inventory:
- a. undergo a phonological process,
 - b. trigger a phonological process, or
 - c. exemplify a static distributional restriction.

Phonologically active classes were collected from grammars of 561 languages (all the grammars available on the shelves in Library of Congress PA-PM at the Ohio State University and Michigan State University libraries), about 17,000 sound patterns. Looking only at the classes which undergo or trigger processes

(1a-b), there are 6077 distinct classes, some representing multiple sound patterns in a particular language.

Feature analyses of all classes were performed in three well-respected feature theories: Preliminaries (Jakobson, Fant, and Halle 1954), SPE (Chomsky and Halle 1968), and Unified Feature Theory (Clements and Hume 1995). All of the classes discussed here are naturally occurring, and the terms “natural” and “unnatural” will only be used in reference to a specific feature theory, as defined in (2) and (3).

- (2) Natural class: A class of sounds is natural with respect to a particular theory if the class is storable as a conjunction of features in that theory.
- (3) Unnatural class: A class of sounds is unnatural with respect to a particular theory if it is not storable as a conjunction of features, but rather requires special treatment, such as disjunction or subtraction of natural classes, or is unstable in terms of features in the theory.

The ability of three feature systems to characterize 6077 phonologically active classes with a conjunction of distinctive features is shown in Table 1.

Feature System	Characterizable (Natural)		Noncharacterizable (Unnatural)	
<i>Preliminaries</i>	3640	59.90%	2437	40.10%
<i>SPE</i>	4313	70.97%	1764	29.03%
Unified Feature Theory	3872	63.72%	2205	36.28%
ANY SYSTEM	4579	75.35%	1498	24.65%

Table 1. The ability of three feature systems to characterize 6077 phonologically-active classes

Unnatural classes are not particularly rare. 1496 classes (24.65%) are unnatural in all of these feature theories. Of these, some are non-recurrent “crazy” classes and others are recurrent classes which may involve shared phonetic properties, but properties which do not happen to have features in these theories.

An example of the former “crazy” type of class occurs in Kolami (Emeneau 1961:46-50). The suffix /-(u)l/ is a plural marker for a variety of nouns, and the allomorphy is phonologically conditioned. The [-l] allomorph is conditioned by /t d ŋ i i: e e: a a:/, while the [-ul] allomorph is conditioned by /p t k d g s v z m ŋ j/. Even if one allomorph is treated as basic and the other derived, there is no way to characterize a derived class in terms of traditional distinctive features, or to describe it in terms of shared phonetic properties. The most glaring reason for the unnaturalness of this class is the fact that the dental nasal patterns with the retroflex stops but not the dental stops.

There are also less crazy “unnatural” class which can be described in terms of shared phonetic properties even if they cannot be characterized in terms of traditional distinctive features. One of these occurs in Eastern Cheremis (Sebeok 1961). The class of nasals and lateral liquids triggers the lenition of a preceding /d/. This class is unnatural in many feature theories because nasals and lateral liquids share no features to the exclusion of all other segments in the inventory, which includes a dental flap that does not trigger lenition. In some theories, such as Unified Feature Theory, nasals and laterals are both treated as [+sonorant, –continuant], but so is the flap.

Nasals and lateral liquids are acoustically similar, both having antiformants generated by side cavities, and so it is not surprising that they pattern together in many languages. They pattern together in “unnatural” classes in Eastern Cheremis, Toba (Klein 2001), and Warlpiri (twice) (Nash 1986), and many “natural” classes in a wide variety of languages. In most cases, what determines whether the class is natural or not is whether there is another [+sonorant, –continuant] segment in the inventory. The fact that nasals and lateral liquids may pattern together regardless of whether they are a natural class in most feature theories suggest that it may be the shared phonetic property, rather than shared innate features, that is important.

Flemming (2002) proposes an auditory feature common to laterals and nasals. Adding new innate features in a similar fashion enables classes to be rendered natural while maintaining a distinction between natural and unnatural classes. This distinction predicts that there should be some other evidence of a difference between the two types of classes. The following sections investigate this.

3. Predictions

If features are not innate, then they must emerge in language acquisition, language change, etc., rather than having evolved. Emergent features would need to be accounted for in terms of language change, social and cognitive factors, and phonetic facts, including the phonetic facts many features are grounded in.

There are many similarities between a theory with no innate features (in which features (or “features”) emerge as necessary to account for sound patterns) and a theory with a very large number of innate features (in which features are selected as necessary to account for sound patterns). In the former case, every measurable phonetic property can potentially form the basis for grouping of segments (and thus the emergence of a feature), while in the latter case, every measurable phonetic property may potentially have an innate feature associated with it which can form the basis for a grouping of segments. The discussion in this paper will contrast a theory with a small restrictive set of innate features with one in which features emerge (or are selected from a very large set) in order to account for sound patterns encountered by the language learner. This is discussed further in Section 4.

Models with innate and emergent features make different predictions about

what types of phonological patterns are expected. First, innate features predict a well-defined boundary between natural and unnatural classes, while emergent features predict a smooth transition. Second, because they tie phonological patterns more closely to their gradient phonetic roots, emergent features predict that segments with relatively unpredictable phonological patterning (like /l/) will also be relatively ambiguous phonetically.

4. Testing Predictions

Innate features predict that “unnatural classes” which cannot be described in terms of the correct feature set will either be nonexistent or rare and nonrecurrent. Emergent features predict tendencies toward certain types of classes, with some being more likely than others and no clear boundary between common and marginal classes. Figure 1 shows the distribution of natural and unnatural classes in Unified Feature Theory, representative of the three theories examined. Each bar represents a different feature specification (i.e., one or more conjoined features (such as “[+high]” or “[+high, –back]”) for natural classes, or feature disjunction or subtraction (such as “[+high] \vee [–back]” or “[+high] – [–back, +round]”) for unnatural classes). The height of the column indicates the number of occurrences of that class among the 6077 classes. Light bars are natural classes, and dark bars are unnatural.

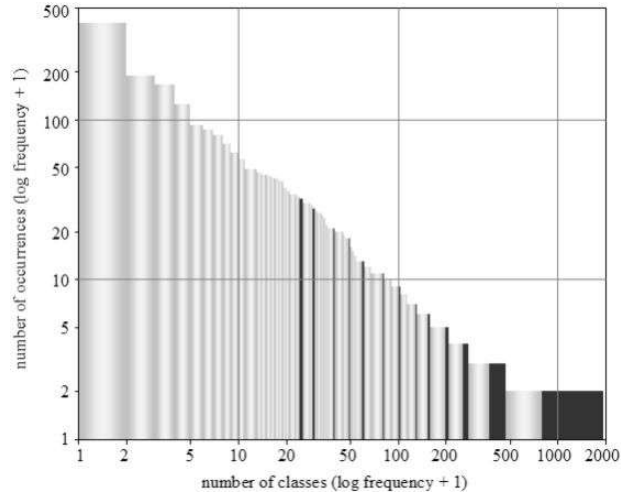

Figure 1. Distribution of frequent and infrequent classes (UFT)

As seen in the figure, many of the classes the theory treats as unnatural are quite numerous. Further, the natural and unnatural classes are interleaved. There is certainly nowhere to draw a boundary between frequent/recurrent/possible

natural classes and rare/idiosyncratic/impossible unnatural classes. Compared to Unified Feature Theory, Preliminaries has fewer natural classes which outrank all of the unnatural classes. This is due in large part to the smaller number of features employed in the Preliminaries system. SPE does the best job of having natural classes as the most frequent. It does this in part by overgenerating. Indeed, the vast majority of feature combinations which define natural classes in SPE (and the other theories) are unattested, while many unnatural classes are recurrent. These can be made “natural” by adding new features, but dealing with all of the unnatural classes in this way would require a very large number of features, and a theory indistinguishable from one in which features emerge as necessary.

These results show that in general, these theories exclude from naturalness many naturally-occurring classes, including many which are quite common. A specific example of this is in predicted subgroupings of place. Different feature theories predict different possible subgroupings of place of articulation (Labial, Coronal, and Dorsal) among consonants (Table 2). All three subgroupings involve places of articulation with clear acoustic and/or articulatory properties in common, and each theory predicts that some should be rare or unattested because they have no feature specification in the theory.

Feature System	Lab & Cor	Cor & Dor	Lab & Dor
Preliminaries	[diffuse] (excludes (alveo-)palatals)	NO	[grave] (incl. palatals, excl. uvulars)
SPE	[+ant] (excludes (alveo-)palatals)	NO	[–cor] (incl. palatals, uvulars, etc.)
UFT	NO	[Lingual]	NO
Actual	n = 127	n = 132	n = 101

Table 2. Subgroupings of place

In fact, all three pairs of places are robustly attested. Each theory is right about the subgroupings of places it predicts, but wrong about the ones it excludes. The only reason not to expect these subgroupings is that some theories prohibit them, but this is clearly not right. Indeed, the fact that various groupings are observed is part of the reason why there are many feature theories. Each theory predicts an internally-consistent set of possible generalizations, and this is part of a larger picture. This picture includes a wide range of phonetic dimensions which are variably exploited by different feature theories.

Teasing apart the phonetic dimensions from phonetically-defined features is

very important for addressing the question of whether phonetically-defined features, or the phonetic dimensions themselves, are responsible for naturalness in phonology. An area where this can be explored is segments which seem to have variable feature specifications. From a phonetic perspective, this may not be surprising, because phonetic dimensions are not equally applicable to all segments. For example, the opposition $[\pm\text{continuant}]$ is good for [t] vs. [s], but lousy for [l], and the opposition $[\pm\text{sonorant}]$ is good for [b] vs. [w], but lousy for [h]. Phonology mirrors the gradient, multidimensional nature of phonetics, in spite of categorical features. For example, /l/ appears to be $[\text{+continuant}]$ in some languages and $[\text{-continuant}]$ in others. Other segments and other features are more consistent. Figure 2 shows the segments which pattern with lateral approximants, in classes which are only natural if the feature [continuant] (with either the + or – value) is involved. For these classes to be natural, the lateral liquids need to be specified as $[\text{+continuant}]$ and $[\text{-continuant}]$ about equal amounts of the time.

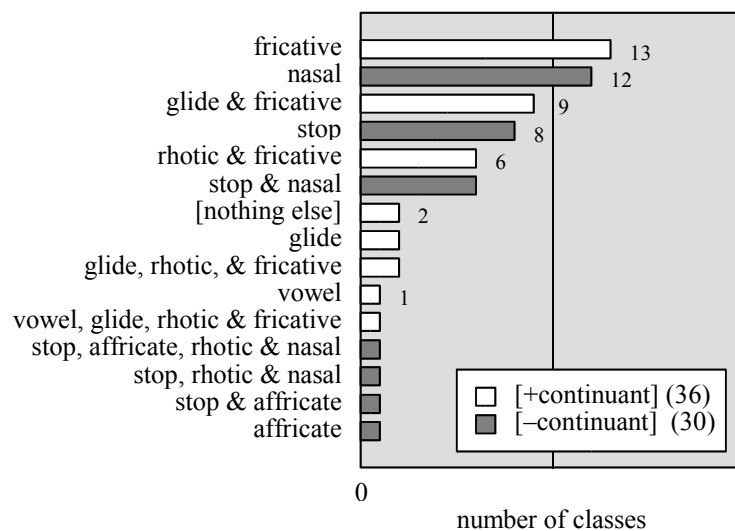

Figure 2. Other members of $[\text{+cont}]$ and $[\text{-cont}]$ classes with lateral liquids

For innate features, features are most important for predicting patterning of sounds. For emergent features, the phonetic dimensions that features are grounded in are most important for predicting patterning. Innate features cannot account for why some segments and features are ambivalent, and others are more consistent. Emergent features predict that segments which are least phonetically distinct will be most ambivalent phonologically. Similarly, features with less clear phonetic correlates (like [continuant]) should be involved in more ambivalent cases. Table 3 shows the number of cases in which coronal voiced

fricatives, laterals, nasals, and voiced stops pattern with continuants or non-continuants (in classes which are only natural if the feature [continuant] is involved). The canonical continuants (fricatives) pattern consistently with other continuants, while the canonical non-continuants (oral stops) pattern consistently with non-continuants. Nasals and lateral approximants are not canonical continuants or non-continuants, and they pattern with segments at both ends of the continuancy spectrum.

	[+continuant]		[-continuant]	
/z z z,ʒ ʒ j/	41	87.2%	6	12.8%
/l l l,ʎ/	36	52.9%	32	47.1%
/n n n,p/	17	44.7%	21	55.3%
/d d d,t/	1	2.3%	43	97.7%

Table 3. The patterning of four groups of sounds with respect to [continuant]

Innate distinctive features are most reliable for predicting the behavior of phonetically unambiguous segments. This is where innate features are least necessary, because natural classes can be predicted on the basis of clear phonetic similarities. In the phonetic gray areas, innate features would be expected to define clear boundaries between two values of a feature. However, the phonological patterning of these sounds is as varied as the phonetic cues are ambiguous. Innate features are categorical and phonetic dimensions are gradient, and the likelihood of participation in natural classes appears also to be gradient.

It has been seen in this section that laterals and nasals, which are not close to either end of the continuancy opposition, can be involved in generalizations involving segments closer to either end. Other phonetically ambiguous segments may similarly be subject to different competing, overlapping generalizations. In innate feature theory, the innate features provide the generalizations. Different feature theories (correctly) identify different generalizations which may overlap and contradict each other. The fact that “contradictory” data are well attested (place groupings, ambivalent segments, etc.) calls for a model in which this is not contradictory.

5. Emergent Feature Theory

Phonetically-defined innate features are just one way to describe classes of phonetically similar segments. Without features, there are still reasons to expect natural class behavior. First, some recurrent natural classes can be accounted for directly from sound change. If phonetic nasalization affects all vowels, and this is reinterpreted as phonology, the resulting alternation would likely affect the classes of vowels and nasals. Second, generalization is a general cognitive process by which observations about a stimulus are applied to similar stimuli. An

observation about the patterning of /p/ can be interpreted as an observation about labial sounds, an observation about sounds with no vocal fold vibration, etc.. The “wrong” generalization may lead to an accidental extension of a class, presumably to some phonetically-coherent set. The result is likely to be a phonetically natural class.

There is an illustrative example in the interaction between the phonetic effect F0-lowering and phonological depressor consonants. Voiced obstruents and (to a lesser extent) sonorants have the phonetic effect of lowering the F0 of a following vowel. Implosives and voiceless aspirated consonants cause phonetic F0 raising (Hyman and Schuh 1974). In phonological tone-lowering, all known classes of triggers (depressor consonants) include voiced obstruents. Some include sonorants (Bradshaw 1998). In Zina Kotoko (Chadic), voiced obstruents, sonorants, glottal stop, and implosives are all depressors (Odden 2002). It is reasonable to suspect that this originated from phonetic F0 lowering caused by voiced obstruents and sonorants (but not implosives or glottal stop). This must have involved generalization according to the “wrong” phonetic property (voicing, instead of F0-lowering).

Most innate feature theories use phonetically-defined features. If features are not innate, then the classes they correctly predict must be attributed to the phonetic dimensions the features are grounded in. In Emergent Feature Theory (Mielke 2004)², phonologically active classes can result from generalization to groups of phonetically similar segments. A variety of independently-observable factors account for many observations about sound patterns. In interpreting the sound patterns confronted during acquisition, a learner constructs abstract features which reflect these factors. The relationships between phonetics, features, and sound patterns are different in innate and emergent feature theories. In innate feature theories, sound patterns are built out of features, which are in turn phonetically grounded. Phonetics and “external” factors may be invoked in cases where features are unable to account for observed found patterns. In Emergent Feature Theory, naturalness among sound patterns is attributed to phonetic pressures and other factors. Features develop in a learner's interpretation of sound patterns confronted in the language being acquired.

A model of phonetic similarity should be able to predict likely phonologically active classes at least as well as any phonetically-based feature theory. Crucially, the model needs to be rooted in something other than phonetic features. A pilot phonetic similarity model draws on data from Wang and Bilger's (1973) perception study of confusions among 25 English consonants. The confusion matrices were converted into a distance matrix, and multidimensional scaling produced a 5-dimensional model. A second 4-dimensional model was combined with an ersatz place dimension, to see what would happen. Segments that are close together along some combination of these dimensions should be more likely than an arbitrary group of segments to be involved in a sound pattern. A pairwise single-linkage hierarchical clustering algorithm was used to locate clusters of similar segments.

Fifteen languages in the database employ a subset of the 25 consonants from the Wang and Bilger study, and 59 classes in these languages involve only consonants. Scoring schemes were chosen in order to be in the spirit of how different theories handle unusual classes, and randomly created classes were used as a control. Each model ideally should give high scores to the randomly-selected classes and low scores to the actual classes. Figure 3 shows the results: all three models are significantly able to discriminate naturally-occurring classes from randomly generated ones, but the differences between the three models are insignificant. The fact that such rudimentary models with a basis in phonetic similarity are competitive with innate feature models give reason to be optimistic about more sophisticated models.

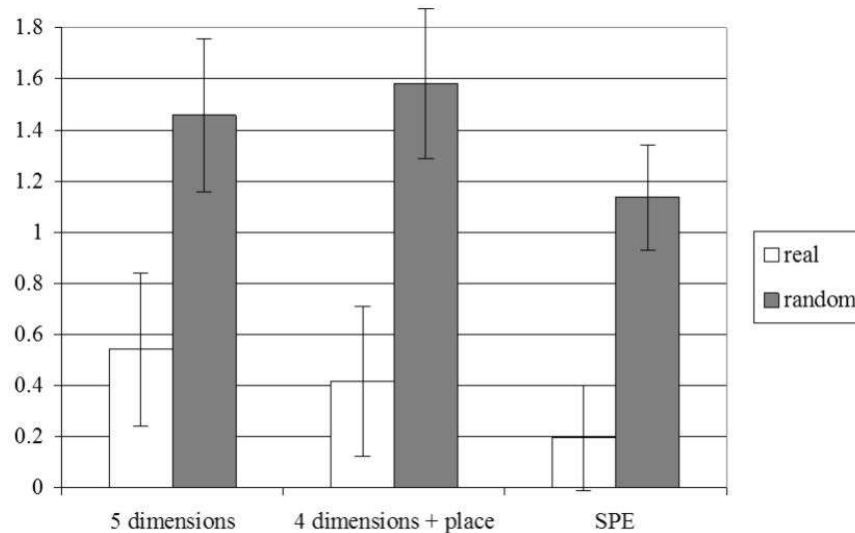

Figure 3. Means and 95% confidence intervals for three models' ability to distinguish real from random classes

6. Emergent Feature Theory

Although they are frequently marginalized, “unnatural classes” are actually quite numerous, and part of the reality of language, and there is no boundary between natural and unnatural classes. Fortunately, many of the insights of innate feature theory can be recast in Emergent Feature Theory. A greater integration of observations about sound patterns with an understanding of the many factors impacting sound patterns should enable phonologists to build upon, rather than tear down, the discoveries of innate feature theory.

Notes

- 1 This research was made possible by funding from a Presidential Fellowship from The Ohio State University, and by help from a lot of people, especially Mike Armstrong, Mary Beckman, Chris Brew, Robin Dodsworth, Beth Hume, Keith Johnson, Brian Joseph, and Giorgos Tserdanelis. This paper has benefited from comments from Diana Archangeli and audience members at WECOL, MOT 2003, MCWOP 9, LSA 2004, Arizona, VarPhon, and NELS 2004.
- 2 Emergent Feature Theory is at least partially consistent with and/or inspired by a good deal of work in synchronic and diachronic linguistics, e.g., Martinet (1968), Andersen (1973), Anttila (1977), Anderson (1981), Ohala (1981, 1993), Ladefoged (1984), Lindblom (1984, 1990, 1999), Corina and Sagey (1989), Beddor (1991), Labov (1994, 2001), Port (1996), Steels (1997), Bybee (1998), MacWhinney (1998), Dolbey and Hansson (1999), Buckley (2000), deBoer (2000), Hale and Reiss (2000), Hume and Johnson (2001a), Hyman (2001), Kochetov (2002), Myers (2002), Vaux (2002), Beckman and Pierrehumbert (2003), Hamann (2003), Janda (2003), Janda and Joseph (2003), Pierrehumbert (2003), Pulleyblank (2003), Yu (2003), Blevins (2004), Culicover and Nowak (2004), Hume (2004), Wedel (2004)...

References

- Andersen, Henning. 1973. "Abductive and deductive change", *Language* **49**:765-793.
- Anderson, Stephen R. 1981. "Why phonology isn't 'natural'", *Linguistic Inquiry* **12**:493-539.
- Anttila, Raimo. 1977. *Analogy*. The Hague: Mouton.
- Beckman, Mary, and Janet Pierrehumbert. 2003. "Interpreting 'phonetic interpretation' over the lexicon", In J. Local, R. Ogden, and R. Temple (ed.), *Papers in Laboratory Phonology VI*. Cambridge: Cambridge University Press. 13-37.
- Beddor, Patrice Speeter. 1991. "Predicting the structure of phonological systems", *Phonetica* **48.2-4**:83-107.
- Blevins, Juliette. 2004. *Evolutionary Phonology*. Cambridge: Cambridge University Press.
- Buckley, Eugene. 2000. "What should phonology explain?" Handout from SUNY Buffalo linguistics colloquium.
- Bybee, Joan. 1998. "Usage-based phonology", In Darnell et al. 1999. 211-242.
- Chomsky, Noam, and Morris Halle. 1968. *The Sound Pattern of English*. Cambridge, Mass.: MIT Press.
- Clements, G.N. and Elizabeth V. Hume. 1995. "The Internal Organization of Speech Sounds", in Goldsmith, John (ed.) *The Handbook of Phonological Theory*. Cambridge Mass.: Blackwell. 245-306.
- Corina, David P. and Elizabeth Sagey. 1989. "Are phonological hierarchies universal? evidence from American Sign Language", In de Jong, Ken and Yongkyoon No (ed.) *Proceedings of the Sixth Eastern States Conference on Linguistics*. 73-83.
- Culicover, Peter W., and Andrzej Nowak. 2004. *Dynamical Grammar*. Oxford: Oxford University Press.
- Darnell, M., E. Moravcsik, F. Newmeyer, M. Noonan, and K. Wheatley, ed. 1999. *Functionalism and Formalism in Linguistics Volume 1: General Papers*. Amsterdam: John Benjamins.
- Emeneau, M. B. 1961. *Kolami: A Dravidian Language*. Annamalainagar: Annamalai University.
- de Boer, Bart. 2000. *The Origins of Vowel Systems*. Oxford: Oxford University Press.

- Dolbey, A.E., and G. Ó. Hansson. 1999. "The source of naturalness in synchronic phonology", In Billings, S., J. Boyle, and A. Griffith (ed.) *CLS* 35 Vol. 1. Chicago: CLS.
- Flemming, Edward 2002. *Auditory Representations in Phonology*. New York: Routledge.
- Hale, Mark, and Charles Reiss. 2000. "Phonology as cognition", In Burton-Roberts, N., Philip Carr, and Gerard Docherty (ed.), *Phonological Knowledge: Conceptual and Empirical Foundations*. Oxford: Oxford University Press. 161-184.
- Hamann, Silke. 2003. The phonetics and phonology of retroflexes. University Utrecht PhD Dissertation.
- Hume, Elizabeth V. 2004. "The indeterminacy/attestation model of metathesis", *Language* 80.
- Hume, Elizabeth V., and Keith Johnson. 2001a. "A model of the interplay of speech perception and phonology" In Hume and Johnson 2001b. 3-26.
- Hume, Elizabeth V., and Keith Johnson, ed. 2001b. *The Role of Speech Perception in Phonology*. New York: Academic Press.
- Hyman, Larry M. 2001. "The limits of phonetic determinism in phonology: *{NC} revisited, In Hume and Johnson 2001b.
- Hyman, Larry M., and Russel G. Schuh. 1974. "Universals of tone rules: evidence from West Africa", *Linguistic Inquiry* 5:81-115.
- Jakobson, Roman, C. Gunnar M. Fant, and Morris Halle. 1954. *Preliminaries to speech analysis: the distinctive features and their correlates*. Cambridge, Mass.: MIT Press.
- Janda, Richard D. 2003. "Phonologization" as the start of dephoneticization — or, on sound-change and its aftermath: Of extension, generalization, lexicalization, and morphologization. In Joseph and Janda 2003. 401-422.
- Janda, Richard D., and Brian D. Joseph. 2003. On language, change, and language change — or, of history, linguistics, and historical linguistics. In Joseph and Janda 2003. 3-180.
- Joseph, Brian D., and Richard D. Janda, ed. 2003. *The Handbook of Historical Linguistics*. Oxford, UK: Blackwell.
- Klein, Harriet E. Manelis. 2001. *Toba*. Muenchen: Lincom Europa.
- Kochetov, Alexei. 2002. *Production, perception, and emergent phonotactic patterns: A case of contrastive palatalization*. New York: Routledge.
- Labov, William. 1994. *Principles of Linguistic Change: Internal Factors*. Oxford: Blackwell.
- Labov, William. 2001. *Principles of Linguistic Change: Social Factors*. Oxford: Blackwell.
- Ladefoged, Peter. 1984. "Out of chaos comes order; physical, biological, and structural patterns in phonetics", In Van den Broecke, and Cohen 1984. 83-95.
- Lindblom, Björn. 1984. "Can the models of evolutionary biology be applied to phonetic problems?", In Van den Broecke, and Cohen 1984. 67-81.
- Lindblom, Björn. 1990. "Explaining phonetic variation: a sketch of the H&H theory", In Hardcastle and Marchal (ed.) *Speech Production and Speech Modeling*. Dordrecht: Kluwer. 403-439.
- Lindblom, Björn. 1999. "Emergent phonology", University of Stockholm/University of Texas at Austin ms.
- MacWhinney, Brian. 1998. "Emergent language", In Darnell et al. 1999. 361-386.
- Martinet, André. 1968. "Phonetics and linguistic evolution", In Malmberg, Bertil (ed.) *Manual of Phonetics*. Amsterdam: North-Holland Publishing Company.
- Mielke, Jeff. 2004. The Emergence of Distinctive Features. Ohio State PhD dissertation.

- Myers, Scott. 2002. "Gaps in factorial typology: The case of voicing in consonant clusters", University of Texas at Austin ms. [ROA-509].
- Nash, David. 1986. *Topics in Warlpiri Grammar*. New York: Garland Publishing, Inc.
- Ohala, John J. 1981. "The listener as a source of sound change", In Masek, C.S., R.A. Hendrik, and M.F. Miller (ed.) *CLS 17*. Chicago: CLS. 178-203.
- Ohala, John J. 1993. "Sound change as nature's speech perception experiment", *Speech Communication* **13**:155-161.
- Pierrehumbert, Janet. 2003. "Probabilistic phonology: Discriminability and robustness", In R. Bod, J. Hay, and S. Jannedy (ed.) *Probabilistic Linguistics*. Cambridge, Mass.: MIT Press.
- Port, Robert F. 1996. "The discreteness of phonetic elements and formal linguistics: response to A. Manaster Ramer", *Journal of Phonetics* **24**:491-511.
- Pulleyblank, Douglas. 2003. "Covert feature effects", In Garding, Gina and Mimura Tsujimura (ed.) *WCCFL 22*. Somerville, Mass.: Cascadilla Press. 398-422.
- Sebeok, Thomas A., and Frances J. Ingemann. 1961. *An Eastern Cheremis Manual*. Bloomington/The Hague: Mouton & Co./Indiana University.
- Steels, Luc. 1997. "The synthetic modelling of language origins" *Evolution of Communication* **1**:1-34.
- Van den Broecke, M.P.R. and A. Cohen, ed. 1984. *Proceedings of ICPHS 10*. Dordrecht: Foris Publications.
- Vaux, Bert. 2002. "Consonant epenthesis and the problem of unnatural phonology", Paper presented at Yale University Linguistics Colloquium.
- Wang, Marilyn D., and Robert C. Bilger. 1973. "Consonant confusions in noise: a study of perceptual features", *Journal of the Acoustical Society of America* **54**:1248-1266.
- Wedel, Andrew. 2004. Self-organization and categorical behavior in phonology. UC Santa Cruz PhD dissertation.
- Whitney, W. D. 1960. *Sanskrit Grammar [9th issue of 2nd ed.]*. Cambridge, Mass.: Harvard University Press.
- Yu, Alan C. L. 2003. The morphology and phonology of infixation. UC Berkeley PhD dissertation.

Jeff Mielke
 Department of Linguistics
 Douglass Building 200E
 The University of Arizona
 Tucson, AZ 85721-0028
 mielke@u.arizona.edu

Asymmetry in Double-object Constructions in Turkish

Balkız Öztürk

Harvard University/Boğaziçi University

1. Introduction

Double-object constructions exhibit different characteristics under passivization cross-linguistically. Languages like Swedish, Norwegian and Albanian are symmetric passive languages, where either the goal or the theme can undergo passivization as illustrated in (1). Languages like English, on the other hand, are known to be asymmetric passive languages, since in double-object constructions only the goal can be passivized as shown in (2):

(1) Swedish:

- a. Johan forarades en medalj
 Johan was-presented a medal
 John was presented a medal
- b. Medaljen forarades Johan.
 the-medal was-presented Johan
 The medal was presented John.
 (Anagnostopoulou 2003: 124)

(2) a. Mary gave John a medal.

b. John was given a medal.

c. *The medal was given John.

This contrast in terms of passivization has been accounted for in the literature based on either case or locality constraints. Case theoretic accounts mainly focus on structural vs. inherent case distinctions (Baker 1988, Larson 1988). Locality based accounts, on the other hand, explain the differences in terms of the relative ordering of theme and goal (Anagnostopoulou 2003).

Passivization of double object constructions is also asymmetric in Turkish. Goals, which are always marked with dative case, can never be passivized, but only themes marked with accusative can undergo passivization:

- (3) a. Ayşe Ali-ye bu kitab-ı ver-di.
 Ayşe Ali-dat this book-acc give-past
 Ayşe gave Ali this book.
- b. Bu kitap Ali-ye ver-il-di.
 this book Ali-dat give-pass-past
 This book was given to Ali.
- c. *Ali bu kitab-ı ver-il-di.
 Ali this book-acc give-pass-past
 Ali was given this book.

In this study I argue that neither case- or locality-based accounts can explain the asymmetry observed in Turkish, as this asymmetry is not due to locality or structural vs. inherent case distinctions. I propose that this asymmetry follows from constraints of morphological case realization in the absence of syntactic movement in passivization in Turkish.

2. Relative Ordering of Theme and Goal in Turkish

In Turkish double-object constructions, themes are marked for accusative case, whereas goals are in dative. Since Turkish is a scrambling language, theme and goal can occur in either order as illustrated in (4). However, the theme>goal order is taken to be the preferred one among native speakers (Kornfilt 2003). Then the question is what the basic order for theme and goal is in Turkish:

- (4) a. Ali kitab-ı Ayşe-ye ver-di. (Theme>Goal)
 Ali book-acc Ayşe-dat give-past
 Ali gave Ayşe the book.
- b. Ali Ayşe-ye kitab-ı ver-di. (Goal>Theme)
 Ali Ayşe-dat book-acc give-past
 Ali gave Ayşe the book.

Based on reconstruction possibilities in Japanese ditransitives, it is proposed that goal>theme order is basic and other ordering possibilities are derived from this basic order. This claim is supported by Japanese scope facts, as only the theme>goal order leads to scope ambiguity in Japanese (Hoji 1985, Takano 1998, Yatsushiro 2003):

- (5) a. Taroo-ga dareka-ni dono-nimotu-mo okutta.
 Taro-nom someone-dat every-package sent
 Taro sent someone every package (some>every, *every>some)
- b. Taroo-ga dono-nimotu-mo_i dareka-ni t_i okutta.
 Taro-nom every-package someone-dat sent
 Taro sent someone every package (some>every, every>some)

As seen in (5) only in the theme>goal order there is scope ambiguity, which implies that the theme is derived from a position lower than the goal.

Miyagawa and Tsujioka (2004), on the other hand, propose that there are two separate base positions for dative-marked goal arguments in Japanese. The low goal is interpreted as locative, whereas the high goal is possessive as in (6). This is evidenced by the fact that both goals can occur in the same clause as seen in (7):

- (6) a. high goal (possessive)...low goal (locative)...theme
 b. high goal (possessive)...theme...low goal(locative)
 (Miyagawa&Tsujioka 2004: 8)
- (7) Taroo-ga Hanako-ni Tokyo-ni nimotu-o okutta.
 Taro-nom Hanako-dat Tokyo-to package-acc sent
 Taro sent Hanako the package to Tokyo.
 (Miyagawa&Tsujioka 2004: 9-10)

Now let us consider the reconstruction possibilities in Turkish double-object constructions, which is also a scrambling language.

As for reconstruction in Turkish, scrambling yields A-movement effects and does not allow reconstruction as in (8). However, when contrastive focus is present in the structure, scrambling behaves as an instance of A-bar movement as (9) illustrates (Kural 1991):

- (8) a. Adamlar birbirlerin-i görmüş.
 men each other-acc saw
 The men saw each other
- b. *Birbirlerin-i_i adamlar t_i görmüş.
 each other-acc men saw
- (9) a. Adamlar birbirlerin-i_i DÜN görmüş.
 men each other-acc yesterday saw
 The men saw each other YESTERDAY

b. Birbirlerin-_i adamlar _t DÜN görmüş.
 each other-acc men YESTERDAY saw

As seen in (8b) scrambling leads to ungrammaticality as reconstruction is not possible. However, in (9b) we have a grammatical construction as reconstruction is possible, when contrastive focus is introduced through the preverbal adverbial.

In ditransitives, as in (10a) the goal, preceding the theme can bind it. If A-scrambling derives the theme>goal order, the goal cannot bind the theme as in (10b). However, via contrastive focus, the theme can reconstruct as shown in (10c), implying that the goal is higher. This implies that goal is higher than theme. Similar to Japanese this high goal forces a possessive reading.

- (10) a. Her adam-_{a_i} resm-in-_{i_{i/j}} ver-di-m.
 every man-dat picture-3ps-acc give-past-1ps
 I gave every man his picture.
- b. [resm-in-_{i_{i/j}}]_k her adam-_{a_i} _{t_k} ver-di-m.
 picture-3ps-acc every man-dat give-past-1ps
 I gave every man his picture.
- c. [resm-in-_{i_{i/j}}]_k her adam-_{a_i} _{t_k} DÜN ver-di-m.
 picture-3ps-acc every man-dat yesterday give-past-1ps
 I gave every man his picture YESTERDAY.

Verbs like *koy-* “to put” also take a dative goal. However, this goal is interpreted as locative and under neutral order it follows the theme as in (11a). Goal>theme order leads to ungrammaticality as reconstruction is not possible as shown in (11b). However, when contrastive focus is introduced as in (11c) the ungrammaticality disappears and the goal can reconstruct below the theme. This argues for the opposite of the ordering we have seen in (10), that is, the locative goal is lower than the theme:

- (11) a. Resm-_i çerçeve-si-ne-_{i_{i/j}} koy-du-m.
 picture-acc frame-3ps-dat put-past-1ps
 I put the picture in its frame.
- b. Çerçeve-si-ne-_{i_{i/j}} resm-_i koy-du-m.
 frame-3ps-dat picture-acc put-past-1ps
 I put the picture to his/*its frame.

c. Çerçeve-si-ne_{*i/j} resm-i_i DÜN koy-du-m.
 frame-3ps-dat picture-acc YESTERDAY put-past-1ps
 I put the picture to his/its frame.

(12) a. Resm-in-i_i çerçeve-ye_{*i/j} koy-du-m.
 picture-3ps-acc frame-dat put-past-1ps
 I put his/*its picture in the frame.

b. Resm-in-i_i çerçeve-ye_{*i/j} DÜN koy-du-m.
 picture-3ps-acc frame-dat YESTERDAY put-past-1ps
 I put his/*its picture to the frame.

Reversing the possessor-possessee relationship as in (12) cannot change the binding relations observed in (11) either. In (12a) the goal following the theme cannot bind it and contrastive focus cannot save the structure, either, as it does in (12b). This supports the observation in (11) that there is also a goal position below the theme in Turkish. In other words, as the data above suggests there must be two separate goal positions in Turkish; a high goal with a possessive interpretation and a low goal expressing location:

(13) high goal_{Possessive...} theme ... low goal_{Locative}

This ordering is supported by the availability of two goals in a single sentence. Note that (14) is not fully acceptable due to the double-case restriction in Turkish, which does not allow presence of two constituents bearing the same morphological case within a single clause (Aissen 1974, Zimmer 1976, Taylan 1979, 1984, Göksel 1994). This is what causes the degraded acceptability, yet note that it is in no way fully ungrammatical:

(14) ?Ali bana kitab-ı Ankara-ya yolladı.
 Ali I-dat book-acc Ankara-dat sent
 Ali sent me the book to Ankara.

To summarize, in Turkish in double-object constructions there are two base positions for goals as evidenced by reconstruction facts under contrastive focus. High goals with a possessive interpretation precedes the theme, whereas as locative goals follow it.

3. Passivization in Turkish Ditransitives

Given the discussion above regarding the relative ordering of themes and goals in ditransitives in Turkish, now let us go back to the asymmetry we observe under passivization in Turkish double-object constructions. As illustrated in (3)

above dative arguments can never be passivized, but only the accusative marked arguments can undergo passivization.

Dative case in Turkish, to a certain extent, exhibits inherent case properties. Unlike accusative marked arguments dative case never alternates with nominative case under passivization. Also dative case is never available in ECM constructions in Turkish. Given these properties of dative both locality based accounts and case-theoretic accounts seem to explain why dative marked goals can never be passivized, leading to the mentioned asymmetry. Consider case-theoretic accounts like Larson's (1988). If dative is an inherent case associated with goals it is expected that it will be invisible for passivization. In terms of locality, on the other hand, if we are dealing with a Theme > Low goal order, it is expected that the higher argument theme will be passivized as in (15a). If we are dealing with the High Goal > Theme order, then again given its inherent case the dative goal will not intervene in locality. Therefore, the theme following the high goal can undergo passivization as in (15b).

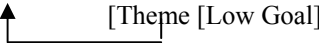
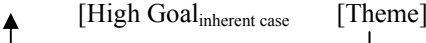
- (15) a. \checkmark []
- b. \checkmark []

Under locality based accounts only a configuration such as (16) yields ungrammaticality. If there is an intervening argument marked with structural case, passivization of the lower argument leads to violation of locality constraints (Anagnostopoulou 2003).

- (16) * []

Thus at first sight Turkish ditransitives do not seem to be an exception for the cross-linguistic behavior of ditransitive constructions under passivization and can easily be accounted for on case or locality based views.

There is, however, one instance of dative case in Turkish, which is observed in causatives and it is definitely structural:

- (17) a. Ayşe bu kitab-ı oku-du.
Ayşe this book-acc read-past
Ayşe read this book.
- b. Ali Ayşe-ye bu kitab-ı oku-t-tu.
Ali Ayşe-dat this book-acc read-caus-past
Ali made Ayşe read this book.

As seen in (17b), when (17a) is causativized, the agent receives structural dative. Note that this dative is not associated with any theta roles, which implies that it has non-inherent case properties. As agents are higher than themes in the structure (Marantz 1984, Kratzer 1994), it is expected that only the higher argument, namely the agent, can be passivized, blocking the passivization of the theme. This is indeed the case in languages like English as illustrated in (18):

- (18) a. John made Bill eat the cake.
 b. Bill was made to eat the cake.
 c. *The cake was made to be eaten by Bill.

The ungrammaticality (18c) follows from locality restrictions as illustrated in (19). Since the agent is marked for structural case and higher in the structure, it is a better candidate for movement than the theme. Therefore, it intervenes and blocks the passivization of the theme argument.

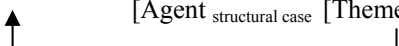
- (19) * []

As the dative in (17b) is non-inherent and also higher in the structure, we would expect it to yield similar locality effects as what we observe in (18c) and thus block the movement of the theme, which is lower in the structure. However, Turkish facts are just the opposite of what is expected. As seen in (20a) it is not possible to passivize the agent argument. On the contrary, only the theme can be passivized, as shown in (20b). Given that both the agent and the theme bear structural case and theme is lower in the structure than the agent, (20b) should be a strict locality violation. However, it is fully grammatical and also it is the only allowed form of passives under causativization. This immediately raises the question how Turkish can be exempt from locality restrictions which apply cross-linguistically, which we will discuss in the following section.

- (20) a. *Ayşe bu kitab-ı oku-t-ul-du.
 Ayşe this book-acc read-caus-pass-past
 Ayşe was made to read that book.
 b. Ayşe-ye bu kitap oku-t-ul-du.
 Ayşe-dat this book read-caus-pass-past
 This book was caused to be read by Ayşe.

4. Passives without Movement

Before we investigate how Turkish is exempt from locality constraints, let us take a look at how passivization works in Turkish.

In causative constructions, unlike the dative marked arguments, when the intervening argument is not dative but accusative, only the higher argument can be passivized:

- (21) a. Ali resm-e bak-tı.
 Ali picture-dat look-past
 Ali looked at the picture
- b. Ayşe Ali-yi resm-e bak-tır-dı.
 Ayşe Ali-acc picture-dat look-caus-past
 Ayşe made Ali look at the picture.
- c. Ali resm-e bak-tır-ıl-dı.
 Ali picture-dat look-caus-pass-past
 Ali was made to look at the picture.
- d. *Resim Ali-yi bak-tır-ıl-dı.
 picture Ali-acc look-caus-pass-past
 The picture was made to be looked at by Ali.

In (21a) the complement of the ver *bak-* “see” takes dative case. When it is causativized, due to the double-case constraint in Turkish, the agent is marked for accusative to avoid double dative as in (21b). Under passivization only the higher agent marked with accusative can become the subject as in (21c), replicating the English facts whereas passivization of the dative theme is not allowed. The data in (20) and (21) are in contradictory terms regarding locality constraints. What is not contradictory about the two sets of data, though, is that in either case dative arguments, whether structural or inherent, resist passivization. Then the question is: Are we really dealing with movement or morphology? If what we are dealing with were simply movement, then we would expect the opposite results in (20) in compliance with locality. However, as (20) highlights locality is not the issue here. The only way to avoid locality is to assume that there is no movement in Turkish passives. Then the question is: How is passivization achieved without movement?

Before we go back to complex cases of passivization as in causatives and ditransitives, let us first take a look at whether there is any movement in passivization of structures with transitive verbs:

- (22) a. [_{TP} [_{NegP} [_{VP} bütün çocuklar çağr]-ıl]-ma]-dı]
 all children invite-pass-neg-past
 All children were not invited. (*all> not, not>all)
- b. [_{TP} Bütün çocuk-lar_i [_{NegP} [_{VP} çağr]-ıl]-ma]-dı-lar]
 all child-pl invite-pass-neg-past-pl
 All children were such that they were not invited. (all> not, *not>all)

In (22a), we adopt to Turkish the tests proposed by Miyagawa (2003) for Japanese and we see that the quantified NP ‘‘all children’’ unambiguously takes narrow scope with respect to negation, which is introduced by NegP. This implies that the theme argument, which becomes the subject under passivization, does not move out of VP. Note the EPP is checked via verbal agreement in Turkish *à la* Alexiadou & Anagnostopoulou (1998) and Öztürk (2001). Raising out of VP to [Spec, TP] is possible though. This leads to the wide scope reading for the subject and triggers Subject-Verb agreement (22b). This strongly suggests that in passives theme argument is not structurally promoted to a higher position via movement. This suggests that case checking is in situ for the subject. See Öztürk (2004, 2005) for details.

If there is no movement in passivization, then what determines the subject status of themes in passives and ensures that they are marked with nominative case?

5. Case Realization in Passives

Kuroda (1988) argues that case in Japanese is not sensitive to phrase structure but to surface order, i.e. morphological realization of case happens top>down following nominative>dative>accusative order. Miyagawa (1991) also distinguishes case assignment from case morphology in Japanese. He proposes that case checking is mediated in two steps: case feature assignment via certain designated heads and morphological case realization via Aspect/Inflection, which takes the whole clause under its scope. Marantz (1991) also proposes that ‘‘Case licensing is not case morphology’’ (Marantz 1991: 241). He distinguishes four types of morphological case: (i) lexically governed case, which is preserved in any circumstances, (ii) dependent case, which is assigned under V-to-I movement, such as accusative and ergative (iii) unmarked case, which is environment sensitive and (iv) default case, which surfaces when no other case realization principle is applicable.

Harley (1995), on the other hand, elaborates on the issue of case realization and proposes the following Mechanical Case Parameter:

- (23) a. If one case feature is checked structurally in a clause, it is realized as Nominative (mandatory case).

- b. If two case features are checked structurally in a clause the second (in a sequential sense) is realized as accusative.
- c. If three case features are checked structurally in a clause, the second is realized as Dative the third as Accusative.
- d. The mandatory case in a multiple-case clause is assigned in the top/bottom AgrP.

In summary, these proposals all argue that case morphology is independent from syntactic case assignment. Turkish also provides evidence for such a proposal:

- (24) a. Ali koş-tu.
 Ali run-past
 Ali ran.
- b. Ayşe Ali-yi koş-tur-du.
 Ayşe Ali-acc run-cause-past
 Ayşe made Ali ran.
- (25) a. Ali balığ-ı tuttu.
 Ali fish-acc caught
 Ali caught the fish.
- b. Ayşe Ali-ye/*yi balığ-ı tut-tur-du.
 Ayşe Ali-dat/acc fish-acc catch-cause-past
 Ayşe made Ali caught the fish.
- (26) a. Ayşe Ali-ye gül-dü.
 Ayşe Ali-dat laugh-past
 Ayşe laughed at Ali.
- b. Ahmet Ayşe-yi/*ye Ali-ye gül-dür-dü.
 Ahmet Ayşe-acc/dat Ali-dat laugh-cause-past
 Ahmet made Ayşe laugh at Ali.

In causativized unergatives in Turkish the agent gets accusative as in (24), whereas causativization of a transitive yields a structure where the agent is marked for dative as the second argument and the object is marked for accusative as the third as seen in (25). However, if there is an inherent dative as in (26a) then the agent can only get accusative as the second argument to be marked for structural case. Thus, Turkish morphological case realization is

relative to the number of arguments in a given structure (Aissen 1974, Zimmer 1976, Taylan 1979, 1984, Göksel 1994).

The dependency of accusative on the presence of nominative case in a given clause has been widely noticed in the literature (Yip, Maling&Jackendoff 1987, Harley 1995, Jónsson 1996, Schütze 1997, Burzio 2000, Mahajan 2000, Woolford 2003 et al.). Accusative in Turkish can also be realized only if there is a nominative NP in the same clause. In passives if it is assumed that passive morphology suppresses the agent, then the theme, though it is still VP-internal, will be the only NP available to check syntactic case.

- (27) a. Ali cam-ı kır-dı.
 Ali window-acc break-past
 Ali broke the window.
- b. Cam kır-ıl-dı.
 window break-pass-past
 The window was broken.

At the level of morphology, the theme in (27b) cannot retain its accusative case, as it is dependent on nominative. Therefore, it has to be realized as nominative in situ. This is fully compatible with the views that nominative is the mandatory case (cf. Harley 1995) or it is the least marked case (cf. Woolford 2003) so that it has the priority over other structural cases. In Turkish, only nominative can agree with T head in finite clauses, which highlights its superior status as a structural case. Note that inherent case is always retained in passive constructions as it is not a dependent case like accusative, as in (28). As shown in (29) the dative theme also does not raise out of VP taking scope over negation, again highlighting the absence of movement in passives:

- (28) a. Ali top-a vur-du.
 Ali ball-dat kick-past
 Ali kicked the ball
- b. Top-a vur-ül-du.
 ball-dat kick-pass-past
 The ball was kicked.
- (29) Bütün top-lar-a vur-ül-ma-dı.
 all ball-pl-dat kick-pass-neg-past
 All the balls were not kicked. (*all>neg, neg>all)

As we have seen passivization of ditransitive constructions in Turkish does not comply with cross-linguistic locality restrictions. This suggests that ditransitive

passives similar to transitive passives are not derived via movement either. What enables the realization of nominative case on the theme argument is simply morphology.

- (30) a. Ayşe Ali-ye bu kitab-ı yolla-dı
 Ayşe Ali-dat this book-acc send-past
 Ayşe sent this book to Ali.
- b. *Ali-ye bu kitab-ı yolla-n-dı.
 Ali-dat this book-acc send-pass-past
 Ali was sent this book.
- c. Bu kitap Ali-ye yolla-n-dı.
 this book Ali-dat send-pass-past
 This book was sent to Ali.
- d. *Ali bu kitab-ı yolla-n-dı.
 Ali this book-acc send-pass-past
 Ali was sent this book.

When via passivization the agent is suppressed in (30a), accusative case on the theme cannot be retained, as it is dependent on the presence of a nominative case in the clause. Therefore, (30b) is ungrammatical. As dative never alternates with nominative in Turkish, the goal cannot get nominative and be interpreted as the subject, as shown by the ungrammaticality of (30d). This leaves (30c) as the only option since only accusative marked on the theme can alternate with nominative. Marking the theme nominative makes it become the subject, since nominative is the only case in Turkish, which can agree with a finite T. Thus, the asymmetry observed in ditransitives is not a locality-based asymmetry but it is a morphological asymmetry: dependent vs. inherent case.

Lack of movement in ditransitives is highlighted by the scope facts as well:

- (31) a. [_{TP} [_{NegP} [_{VP} bütün çocuklar okul-a yolla-n]-ma]-dı]
 all children school-dat send-pass-neg-past
 All children were not sent to school. (*all> not, not>all)
- b. [_{TP} Bütün çocuk-lar_i [_{NegP} [_{VP} okul-a yolla-n]-ma]-dı-lar]
 all child-pl school-dat send-pass-neg-past-lar
 All children were such that they were not sent to school.
 (all>not, *not>all)

As seen in (31) the verb *yolla-* “send” assigns a theme and a locative goal ordered as theme>locative goal. In (31a) the theme subject cannot take scope

over negation implying that it is VP internal. Only in (31b), when it raises to TP, it can get wide scope, which in return triggers overt agreement with the verb. The verb *yolla-* “send” in (32), on the other hand, has an animate high goal, rather than a low locative goal, ordered higher than the theme.

- (32) a. [_{TP} [_{NegP} [_{VP} Ali-ye bütün paket-ler yolla]-n]-ma]-dı]
 Ali-dat all package-pl send-pass-neg-past
 All the packages were not sent to Ali. (*all> not , not>all)
- b. [_{TP} bütün paket-ler_i [_{NegP} [_{VP} Ali-ye t_i yolla]-n]-ma]-dı]
 all package-pl Ali-dat send-pass-neg-past
 All the packages were not sent to Ali. (all> not , *not>all)

As seen in (32a), the theme subject takes narrow scope with respect to negation, suggesting that it is still VP internal. However, scrambling of the theme over high goal forces wide scope for the theme under neutral intonation. This implies that the theme has left its VP internal position, but not necessarily for case purposes.

6. Conclusion

As the discussion above suggests, Turkish ditransitive constructions present a morphological asymmetry in contrast to locality based asymmetries observed in languages like English. As passivization is not derived via movement, Turkish does not violate any of the locality constraints, which hold for other languages.

References

- Aissen, J. 1974. *The Syntax of Causative Constructions*. Ph.D. Dissertation, Harvard University, Cambridge, Massachusetts.
- Alexiadou, A. and E. Anagnostopoulou. 1998. “Parameterizing AGR: Word order, V-movement and EPP checking”, *Natural Language and Linguistic Theory* 16: 491-531.
- Anagnostopoulou, E. 2003. *The Syntax of Ditransitives: Evidence from Clitics*. Berlin-New York: Mouton de Gruyter.
- Baker, M. 1988. *Incorporation: A theory of grammatical function changing*. Chicago: Chicago University Press.
- Burzio, L. 2000. “Anatomy of a Generalization”, *Arguments and Case: Explaining Burzio’s Generalization*, ed. Eric Reuland, Amsterdam: John Benjamins, 195-240.
- Göksel, A. 1993. *Levels of Representation and Argument Structure in Turkish*. Ph.D. Dissertation, SOAS, University of London.
- Harley, H. 1995. *Subjects, Events and Licensing*. Ph.D. Dissertation, MIT.
- Hoji, H. 1985. *Logical Form Constraints and configurational Structures in Japanese*. Ph.D. Dissertation, University of Washington.
- Jónsson, J. G. 1994. “On Case and Agreement in Icelandic”, *University of Massachusetts Occasional Papers in Linguistics*, 17: 85-101.

- Kornfilt, J. 2003. "Scrambling, Subscrambling and Case in Turkish", *Word Order and Scrambling*, S. Karimi (ed.), Blackwell, 125-155.
- Kratzer, A. 1994. "Severing the External Argument from its Verb", *Phrase Structure and The Lexicon*, J. Rooryck & L. Zaring (eds.), Dordrecht: Kluwer Academic Publishers, 109-137.
- Kural, M. 1991. Properties of Scrambling in Turkish. ms. UCLA.
- Kuroda, S.Y. 1988. "Whether we agree or not: A comparative syntax of English and Japanese", *Linguistic Investigations XII*: 1-47.
- Larson, R. 1988. "On the double object constructions", *Linguistic Inquiry*, **19**: 335-392.
- Mahajan, A. 2000. "Oblique Subjects and Burzio's Generalization", *Arguments and Case: Explaining Burzio's Generalization*, Eric Reuland (ed.), Amsterdam: John Benjamins, 79-102.
- Marantz, A. 1984. *On the Nature of Grammatical Relations*. Cambridge: MIT Press.
- Marantz, A. 1991. "Case and Licensing", *Proceedings of ESCOL 8*, G.F. Westphal, B. Ao and H-R. Chae (eds.), University of Maryland, Baltimore, 234-253.
- Miyagawa, S. 1991. Case realization and Scrambling, ms. Ohio State University.
- Miyagawa, S. 2001. "A-Movement Scrambling and Options without Optionality", *Word Order and Scrambling*, S. Karimi (ed.), Blackwell Publishers, 177-200.
- Miyagawa, S. and T. Tsujioka. 2004. "Argument Structure and Ditransitive Verbs in Japanese", *Journal of East Asian Linguistics*, **13**: 1-38.
- Öztürk, B. 2001. "Turkish as a non-pro-drop language", In *The Verb in Turkish*, E. E. Taylan (ed.), Amsterdam: John Benjamins, 239-259.
- Öztürk, B. 2004. Case, Referentiality and Phrase Structure. Ph.D. Dissertation, Harvard University.
- Öztürk, B. 2005. *Case, Referentiality and Phrase Structure*. Linguistik Aktuell 77, Amsterdam, John Benjamins.
- Schütze, C. 1997. INFL in Child and Adult Language: Agreement, Case and Licensing. Ph.D. Dissertation, MIT.
- Takano, Y. 1998. "Structure within VP in Japanese", *Proceedings of Japanese-Korean Linguistics 8*, D. Silva (ed.), Stanford, California: CSLI, 501-514.
- Taylan, E.E. 1979. "An Odd Case in the Causative Construction in Turkish", *Proceedings of Chicago Linguistic Society 15*, Chicago University Press.
- Taylan, E. E. 1984. *The Function of word order in Turkish grammar*. Berkeley, California: University of California Press.
- Woolford, E. 2003. "Burzio's Generalization and Markedness", *New Perspectives on Case Theory*, E. Brandner and H. Zinsmeister (eds.), Stanford, California: CSLI Publications, 301-330.
- Yatsushiro, K. 2003. "VP Internal Scrambling", *Journal of East Asian Linguistics*, **12**: 141-170.
- Yip, M., J. Maling and R. Jackendoff. 1987. "Case in Tiers", *Language*, **63**: 217-250.
- Zimmer, K. 1976. "Some Constraints on Turkish Causativization", *The Grammar of Causative Constructions, Syntax and Semantics*, M. Shibatani (ed.), New York: Academic Press, 399-412.

*Balkız Öztürk
Boğaziçi University
Department of Western Languages and Literatures
Bebek-Istanbul, Turkey 34342
balkiz.ozturk@boun.edu.tr*

Agreement of Sentence Final Particles in Jussive Clauses*

Miok Debby Pak

Georgetown University

1. Introduction

Within the GB/Minimalism framework, force is argued to be directly represented in the syntax via an operator for interrogatives or a feature for imperatives residing in a high position of a grammatical structure. These elements in the syntax play the role of marking the clause in which they occur as a member of a certain clause type (Chomsky & Lasnik 1977, Platzack & Rosengren 1998, Han 1998 among others). Proposals along this line have been put forward for Korean, particularly for sentence final particles. The sentence final particles in Korean are considered to mark clause types. Hence, researchers such as Ahn & Yoon (1989), Whitman (1989) and most recently Brandner (2004), among others, have argued that these particles are actually the manifestation of force markers, and they mark sentential mood (i.e., declarative, interrogative, imperative, etc.) which is encoded in MoodP above IP.

In this paper, I address the question of whether the sentence final particles in Korean are really force markers. In so doing, I investigate the role(s) of these particles, focusing on the three types of clauses in (1).

- | | |
|--|---|
| <p>(1)¹ a. IMPERATIVES
 Cemsim-ul mek-e-la
 lunch-ACC eat-IMP
 ‘Eat lunch!’</p> | <p>b. EXHORTATIVES
 Icey kongpwuha-ca
 now study-EXH
 ‘Now, let’s study.’</p> |
| <p>c. PROMISSIVES
 Nayil nay-ka cemsim-ul sa-ma²
 tomorrow I-NOM lunch-ACC buy-PRM
 ‘I will buy lunch tomorrow.’</p> | |

It is generally assumed that the sentence final particles *-la*, *-ca* and *-ma* mark the clauses in (1a-c) as an imperative, exhortative, and promissive, respectively.

However, despite allowing different subjects and sentence final particles, imperatives, exhortatives, and promissives share a significant number of similarities that cannot be put aside as a mere coincidence. Given such facts, in this paper I propose a novel theory of clause types. Within this new theory, I claim that the sentence final particles in (1) are not force markers: Rather they mark persons such as addressee and/or speaker specified by the subject of the clause through an agreement mechanism between the subject and a sentence final particle.

2. Similarities Shared by Imperatives, Exhortatives, and Promissives

The similarities among the three types are as follows. First, when imperatives, exhortatives, and promissives are embedded the embedded subjects show the same restrictions. Consider the following data:

- (2) a. Imperative
 John-i Tom-ekey [(**Ney-ka/*Tom-i*) cip-ey ka-**la**]-
 John-NOM Tom-DAT [(you/Tom-NOM) home-to go-IMP]-
 ko mal-ha-ess-ta
 COMP say-do-PAST-DEC
 (Intended meaning) ‘John ordered Tom to go home.’
- b. Exhortative
 John-i Tom-ekey [(**wuli-ka*) cip-ey ka-**ca**]-ko
 John-NOM Tom-DAT [(we-NOM) home-to go-EXH]-COMP
 mal-ha-ess-ta
 say-do-PAST-DEC
 (Intended meaning) ‘John said to Tom let’s go home.’ (indirect speech)
- c. Promissive
 John-i Tom-ekey [(**nay-ka/*John-i*) nayil tasi
 John-NOM Tom-DAT [(I/John-NOM) tomorrow again
 o-**ma**] ko mal-ha-ess-ta
 come-PRM]- COMP say-do- PAST-DEC
 (Intended meaning) ‘John promised Tom that he would come back tomorrow.’

The examples in (2) show that nominative case marked subjects cannot appear in the embedded subject position of imperatives, exhortatives, and promissives.

Secondly, all three types use the negative marker *-mal* in negative formation.³

- (3) a. Imperative

- Mek-ci **an(i)/mal-a-la*
 Eat-NOM NEG-a-IMP
 ‘Do not eat.’
- b. Exhortative
 Mek-ci **an(i)/mal-ca*
 Eat-NOM NEG-EXH
 ‘Let’s not eat.’
- c. Promissive
 Mek-ci *an(i)h/mal-u-ma*
 Eat-NOM NEG(+do)-u-PRM
 ‘I promise not to eat.’

While the negative marker *-ani* is used in declaratives and interrogatives, imperatives and exhortatives allow *-mal* only and promissives allow both.

Thirdly, imperatives, exhortatives, and promissives do not allow certain mood particles, such as the retrospective mood particle *-te*, the apperceptive mood particle, *-kwun*, the suppositive mood particle *-ci*, and the apprehensive mood particle *-ney*.⁴

- (4) a. Imperative
 *Ne cemsim-ul mek-te/kwun/-ci/-ney-**la**.
 You lunch-ACC eat-RTR/APE/SUP/APR -IMP
- b. Exhortative
 *Wuli cemsim-ul mek-te/kwun/-ci/-ney-**ca**.
 We lunch-ACC eat-RTR/APE/SUP/APR-EXH
- c. Promissive
 *Nay-ka nayil cemsim-ul sa-te/kwun/-ci/-ney-**ma**.
 I-NOM tomorrow lunch-ACC buy-RTR/APE/SUP/APR-PRM

All of these special mood particles are compatible with declaratives and the retrospective *-te* and the suppositive *-ci* are allowed in interrogatives. However, in imperatives, exhortatives, and promissives none of them can be used.

- (5) a. John-i cemsim-ul mek-ess-**tey-yo**./?
 John-NOM lunch-ACC eat-PAST-RTR-POL
 ‘John ate lunch./Did John eat lunch?’
- b. John-i cemsim-ul mek-ess-**ci-yo**./?
 John-NOM lunch-ACC eat-PAST-SUPP-POL
 ‘(Of course,) John ate lunch./John ate lunch, right?’
- c. John-i cemsim-ul mek-ess-**kwun-yo**./*?
 John-NOM lunch-ACC eat-PAST-APPE-POL
 ‘(Ah,) you ate lunch.’

- d. John-i cemsim-ul mek-ess-**ney-yo**./*?
 John-NOM lunch-ACC eat-PAST-APPR-POL
 ‘John ate lunch.’

Fourthly, they do not allow tense markers:

- (6) a. Imperative
 *Mek-ess/-ul/-nun-e-**la**
 Eat-PAST/FUT/PRES-SP-IMP
 b. Exhortative
 *Mek-ess/-ul/-nun-**ca**
 Eat-PAST/FUT/PRES-EXH
 c. Promissive
 *Mek-ess/-ul/-nun -u-**ma**
 Eat-PAST/FUT/PRES-PRM

The data in (6) illustrate that none of the past, future, and present tense markers can occur in these clauses.

Finally, they can all be conjoined by *-ko* ‘and’:

- (7) a. Declarative and imperative
 *John-un sakwa-lul mek-ess-**ko** ne-nun pay-ul
 John-FOC apple-ACC eat-PAST-and you-FOC pear-ACC
 mek-ela.
 eat-IMP
 (intended meaning) ‘John ate an apple and you eat a pear!’
 b. Imperative and promissive
 Ne-nun sakwa-lul mek-**ko** na-nun pay-lul mek-u-ma
 You-FOC apple-ACC eat-and I-FOC pear-ACC eat-u-PRM
 (Intended meaning) ‘You eat an apple and I promise to eat a pear.’
 c. Imperative and exhortative
 Minwoo-nun cip-ey ka-**ko** Yenghee-wa na-nun hakkyo-ey
 Minsoo-FOC home- to go-and Yenghee-and I-FOC school-to
 ka-ca
 go-EXH
 (Intended meaning) ‘Minwoo go home and Yenghee, let’s go to school.’

The coordinator *-ko* can conjoin only clauses of the same type, as shown in (7a). Note that an imperative and a promissive can, however, be conjoined by *-ko* as in (7b), and the coordination of an imperative and an exhortative is also good as shown in (7c).

If we follow the traditional classification that treats imperatives, exhortatives, and promissives as belonging to distinct clause types and views the sentence final particles *-la*, *-ca*, and *-ma* as marking the clause types imperative, exhortative, and promissive, respectively, then these similarities are just a mere coincidence. That is, there is no natural explanation for the similarities. However, given the number of the similarities, we suspect that something beyond coincidence is working. In what follows, I explore a different view of clause types which can provide an explanation for the phenomena under investigation.

3. Jussives

Given the discussion in the previous section, I argue that Korean imperatives, exhortatives, and promissives belong to a single clause type, *jussive*. The jussive clause type expresses a property which is required of some individual, metaphorically added to this individual's "To-do List" (Han 1998, Hausser 1980, Portner (2004), Portner & Zanuttini 2002, Potts 2003). A fundamental hypothesis in this paper is that imperatives, exhortatives, and promissives – while all being jussive in this sense – differ in the person of their subjects. When the subject is second person, referring to the addressee, the result is an imperative; when it is first person, the result is a promissive, and when it is first person inclusive of the addressee, it is an exhortative.

I hypothesize that the semantics of the jussive is built up from three components represented in the syntax. The first is a property *P*: in the case of (1a), the property of eating lunch. The second is a representation of the individual *i* to whose To-do list the property is to be added; in the case of (1a), an imperative, *i* is the addressee, while in the corresponding exhortative *i* would be the speaker and the addressee; in the corresponding promissive *i* would be the speaker. The third component is an intensional variable-binding operator *Modal* which binds *i* as well as the predicate's world variable and makes it the case that the whole jussive denotes a property. Intuitively, the resulting jussive clause denotes the property *P* restricted to the individual *i*. Example (1a) denotes the property of eating lunch restricted to the addressee, formally (8):

$$(8) [\lambda w \lambda x : x = \text{addressee}(\text{context}) . x \text{ eats lunch in } w]$$

In any world in which the addressee eats lunch, this property is true of the addressee and nobody else; in any other world, it isn't true of anyone. Similarly, the example (1c) denotes the property of buying lunch restricted to the speaker. Hence, a promissive would only differ in having "x = speaker (context)" as the restriction on argument *x* while an exhortative like (1b) would denote the

property of studying restricted to the speaker and the addressee. So a formal representation of an exhortative would have “x = speaker and addressee”.

Then given this proposal that imperatives, exhortatives, and promissives are all members of the same clause type called ‘jussives’, the similarities discussed in section 2 are not a mere coincidence any more. Rather they are a natural result. See Pak et al. (2004) for a theoretical account of the similarities.

4. The Role of the Particles: Agreement Markers for Addressee/Speaker

Given above claim, the sentence final particles *-la*, *-ca*, and *-ma* are not force markers. What, then, is/are the role(s) of these particles in Korean? I claim that they are agreement markers marking person(s) of the subject of the sentence in terms of [addressee and/or speaker].

4.1 Agreement of sentence final particles with the subject in jussive clauses

In jussives, the subject is always the addressee in imperatives, the speaker in promissives, and the addressee and speaker in exhortatives. The idea, then, is first, the sentence final particles convey information concerning the subject. More specifically, their job is to express the person(s) whose to-do list is to be updated. Thus, *-la* marks that the subject is the addressee, grammatically realized as second person. The sentence final particle *-ca* in exhortatives marks that the subject is the speaker and the addressee, grammatically realized as first person inclusive of the addressee. *-Ma* in promissives marks that the subject is the speaker, grammatically first person. Second, this role of the particles is achieved through an agreement mechanism between the persons and the particles.

To implement this idea, I claim the followings:

- Cross-linguistically, in jussives the subject must coincide with the addressee/speaker (Mauck et al. 2004). Hence, the individual whose To-do list needs to be updated must coincide with the addressee/speaker. Such restriction on the subject of jussives can be captured by the presence of Addressee/Speaker Projection in the syntax of jussives.
- The sentence final particles are spell outs of the addressee/speaker head and the modal head which are the composite of [+modality, addressee and/or speaker] features in the Distributed Morphology framework.
 - la*: [+modality, +addressee, -speaker]
 - ma*: [+modality, -addressee, +speaker]
 - ca*: [+modality, +addressee, +speaker].⁵
- Modal in jussives is a raising predicate, like other modals, hence the subject raises to the specifier position of ModalP.

- Addressee/SpeakerP semantically binds a variable of the subject in jussives and this achieves the interpretive restrictions on the subject that it always coincides with the addressee/speaker. (See Mauck & Zanuttini 2004 for details)
- As the sentence final particles are spell outs of the Modal and addressee/speaker head, and the subject in jussives is semantically bound by Addressee/SpeakerP, there is a vacuous agreement between the subject and the sentence final particles.

(9) Proposed Clausal Structure

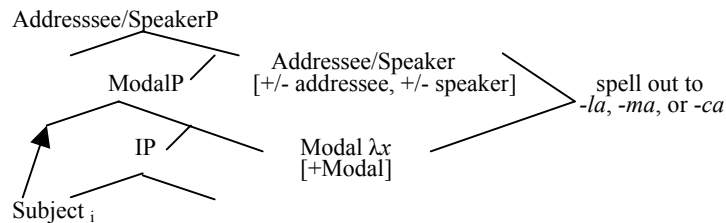
**4.2 Honorific agreement**

Normally Korean is considered to be one of those languages that lack agreement (e.g., Japanese, Chinese, etc). It is true that Korean does not have subject-verb agreement and does not have agreement affixes (for person, number, and gender). But there is another kind of agreement that some researchers have argued to involve agreement mechanism. This is Honorific Agreement.

Honorific agreement in Japanese and Korean has been claimed by many researchers (Harada 1976, Shibatani 1977, Toribio 1990, Boeckx & Niinuma 2004 for Japanese; Ahn 2002 and references therein for Korean). These researchers have claimed that honorific agreement involves at least some kind of syntactic agreement. Arguments for this are first, when both indirect object and direct object are present, only indirect object can trigger honorific agreement on the predicate (Toribio 1990, Boeckx & Niinuma 2004 among others).

(10) Japanese (Boeckx & Niinuma 2004)

- Boku-ga Tanaka sensei-ni Mary-o go-syookai-si-ta
I-NOM Tanaka teacher-to Mary-ACC HON-introduce-do-DEC
'I introduced Mary to Prof. Tanaka.'
- *Boku-ka Many-ni Tanaka sensei-o go-syookai-si-ta
I-NOM Mary-to Tanaka teacher-ACC HON-introduce-do-DEC
'I introduced Prof. Tanaka to Mary.'

(11) Korean

- Mina-ka kyoswunim-ekey tongsayng-ul sokaysikyeye

- M.-NOM professor-to younger sibling-ACC introduce
tuli-ess-ta
give (HON)- PAST-DEC
'Mina introduced the younger sibling to the professor.'
- b. Mina-ka tongsayng-ekey kyoswunim-ul sokaysiykye
M.-NOM younger sibling-to professor-ACC introduce
cwu-ess-ta
give-PAST-DEC
'Mina introduced the professor to the younger sibling.'
- c. *??Mina-ka tongsayng-ekey kyoswunim-ul sokaysiykye
M.-NOM younger sibling-to professor-ACC introduce
tuli-ess-ta
give (HON)- PAST-DEC
- d. *??Mina-ka kyoswunim-ekey tongsayng-ul sokaysiykye
M.-NOM professor-to younger sibling-ACC introduce
cwu-ess-ta
give-PAST-DEC

Second, honorific agreement always requires a syntactically present trigger.

- (12) *Boku ga o-iki-simasu (Toribio 1990)
I NOM HON-go
'I will go for you.'

4.3 Agreement and AgrP

Then, how should we reconcile the facts that Korean (and Japanese) lacks regular subject-verb agreement and that it allows honorific agreement as well as the jussive particle agreement with the subject? Speas (1995) claims that agreement affixes in languages (such as Italian) that have rich agreement, i.e., full agreement paradigm, are strong in that they are listed as individual lexical items in the Lexicon and hence project as head of AgrP in the syntax. On the other hand, those in the languages that have partial agreement (such as English) are weak in that they are only part of a morphological paradigm in the Lexicon and are not listed as individual lexical items. As such, they do not project head of AgrP. Rather, they are inserted in the syntax as a part of verbs. But they need to check the affixal features and hence AgrP is needed. In languages that do not have agreement at all (such as Japanese and Korean), there is no agreement affix hence no features to check. So there is no AgrP in the syntax.

She further claims that the lack of phi-feature agreement in languages such as Korean (and Japanese) should not be taken as lacking other kinds of agreement relation. What is lacking is the AGR head, not the agreement relation. In line with Speas' claim, I also take it that the lack of phi-feature agreement (and agreement affixes) in Korean only means that there is no AgrP in syntax and

does not preclude presence of agreement relation of one kind or another. Other kinds of agreement such as the sentence final agreement with the subject in jussive clauses as well as the honorific agreement need not require the presence of AgrP and the agreement relation can be established through other projections.

5. Conclusion

I have argued for the existence of a clause type “jussive” which arises when its three meaning components are encoded in the syntactic structure. In Korean, this clause type encompasses imperatives, exhortatives and promissives. In this novel view of the theory of clause type called ‘jussives’ the sentence final particles are viewed to mark agreement with the subject of jussives in terms of Addressee/Speaker. More specifically, the particles are the spell-outs of the Modal and Addressee/Speaker head and the agreement with the subject is established by the fact that the Addressee/SpeakerP semantically binds the variable in the subject position in jussives.

There are two theoretical implications of this paper: First, it raises questions to the single operator or morpheme approach to the representation of force in syntax. Second, it argues for the presence of agreement relations in non-agreement languages (i.e., languages lacking phi-feature agreement).

Notes

*The work in this paper is part of the project funded by NSF grant BCS -0234278 ‘Clause Types: Form and Force in Grammatical Theory’ (private investigators, Paul Portner and Raffaella Zanuttini). I thank Paul Portner, Raffaella Zanuttini, and Simon Mauck for their valuable comments and also the audience at WECOL 2004 for the useful comments and discussions. All errors, of course, are mine.

¹In glossing the data, the following abbreviations are used: ACC – accusative case marker, APE – apperceptive mood marker, APR – apprehensive mood marker, COMP – complementizer, DAT – dative marker, DEC – declarative marker, EXH - exhortative particle, FOC – focus marker, FUT – future tense marker, HON – honorific morpheme, IMP – imperative particle, INT - interrogative marker, NEG – negative marker, NMN – nominalizer, NOM – nominative case marker, PAST – past tense marker, POL – politeness particle, PRES – present tense marker, PRM – promissive particle, RTR – retrospective mood marker, SP – speech style particle, SUP – suppositive mood marker.

²The sentence final particle *-ma* in promissives is actually consisting of *-m* and *-a*, the latter of which is classified as a speech style particle. For details on sentence final particles in Korean, see Pak (2004).

³Some native speakers of Korean do not find promissives with *-mal* grammatical at first, but when given a context such as the following, they find them fully grammatical. Imagine a mother bringing six pieces of cake for dessert for family members. Because there are actually seven people, the mother tells one of her children not to eat, so that others (older people) can have one each. The father, feeling bad for the child, says he won’t eat one. Now, the grandmother, feeling bad for her own son, says she won’t eat. The following is the dialogue:

- (i) Mother: Minsoo-ka mek-ci mal-a-la
Minsoo-NOM eat-NMN NEG-SP-IMP

'Minsoo, do not eat (the cake).'
 Father: Aniya, nay-ka an mek-ci.
 No, I-NOM NEG eat-DEC
 'No, I won't eat.'
 Grandmother: Anita, nay-ka mek-ci mal-u-ma
 No, I-NOM eat-NMN NEG-u-PRM
 'No, I won't eat'

⁴The retrospective mood denotes the speaker's past perception, observation, or experience. Hence, this is sometimes referred to as the reportive mood and in Cinque (1999) it is called evidential mood. The apperceptive mood is used when the speaker realizes some fact that s/he did not know before the time of the utterance and the speaker does not assume anything of the hearer's awareness of this fact. This mood is referred to as 'evaluative mood' in Cinque (1999). The suppositive mood is used when the speaker presupposes that the hearer already knows or agrees on the proposition expressed by the utterance. Finally, the apprehensive mood is very similar to the apperceptive mood in that it is used when the speaker comes to the realization of certain fact at the time of the utterance, but it differs in that the speaker assumes that the hearer does not know about this fact.

⁵Alternatively, it is possible to posit [+deictic] feature along with the [+/- addressee] feature to distinguish the system of +deictic (first and second person) from the system of non-deictic (third person) (Benincà and Poletto 2004). Specifically, [+deictic, +addressee] would be the subject features for imperatives, [+deictic, -addressee] for promissives, and [+deictic, +/- addressee] for exhortatives. However, in this talk, I prefer to use the [+addressee, +speaker] features for a couple of reasons: simplicity and presence of third person subject imperatives. Consider the following:

- (i) Taum hwanca tul-e oseyyo.
Next patient in come
 'Next patient come in.'

Above imperative has the third person subject. This kind of data won't be explained with the [+deictic, +/-addressee] features which exclude the third person subject, but will be explained with the feature system of [+addressee, +speaker].

References

- Ahn, Sung-Ho. 2002. Honorification and AgrP. A talk delivered at 2002 Winter Conference of Linguistic of Society of Korean, Seoul National University. Feb. 6, 2002.
- Ahn, Hee-Don and Hang-Jin Yoon. 1989. Functional Categories in Korean. In Susumo Kuno et al. (eds.), *Harvard International Studies on Korean Linguistics*, III: 79-88. Hanshin. Seoul. Korea.
- Boeckx, C. & F. Niinuma. 2004. Conditions on agreement in Japanese. *Natural Language and Linguistic Theory*, 22.3: 453-480. Kluwer Academic Publishers.
- Brandner, E. 2004. Head-movement in minimalism, and V2 as Force-marking. Lohnstein, H. & S. Trissler (eds.) *Interface Explorations 9: Syntax and Semantics of the Left Periphery*. Mouton de Gruyter.
- Cheng, L.-S. 1991. *On the typology of Wh-questions*. PH.D. dissertation, MIT. Cambridge.
- Chomsky, N. and H. Lasnik. 1977. Filters and Control. *Linguistic Inquiry*, 8.3: 425-504.
- Cinque, G. 1999. *Adverbs and Functional Heads: A Cross-Linguistic Perspective*. New York & Oxford: Oxford University Press.

- Han, Chung Hye. 1998. *The structure and interpretation of imperatives: mood and force in Universal Grammar*. Ph.D. dissertation, University of Pennsylvania.
- Han, Chung Hye & Chungmin Lee. 2002. On negative imperatives in Korean. In *Proceedings of the 16th Pacific Asia Conference on Language, Information and Computation*. The Korean Society for Language and Information.
- Harada, S. I. 1976. Honorifics. Masayoshi Shibatani (ed.), *Syntax and semantics 5: Japanese generative grammar*: 299-61. New York: Academic Press.
- Hausser, R. 1980. Surface Compositionality and the Semantics of Mood. In J. Searle, F. Kiefer, & M. Bierwisch, eds., *Speech Act Theory and Pragmatics*. Dordrecht & Boston: D. Reidel, 71-95.
- Mauck, S., M. Pak, P. Portner, & R. Zanuttini. 2005. Clause Typing in Imperatives: A Cross-Linguistic Perspective. Brandstetter, C. and D. Rus (eds.), *Georgetown University Working Papers in theoretical Linguistics*, **IV**: 135-152.
- Mauck, S. & R. Zanuttini. 2005. Subjects of English Imperatives. Brandstetter, C. and D. Rus (eds.), *Georgetown University Working Papers in theoretical Linguistics*, **IV**: 53-86.
- Pak, Miok. 2004. Investigating the role of sentence end particles in Korean. Manuscript. Georgetown University.
- Pak, M., P. Portner, & R. Zanuttini. 2004. Deriving Clause Types: Focusing on Korean. In the *Proceedings of Linguistic Society of Korea 2004*: 359-368. Yonsei Institute of Language and Information Studies.
- Platzack, C. and I. Rosengren. 1998. On the subject of imperatives: A minimalist account of the imperative clause. *The Journal of Comparative Germanic Linguistics*, **1**: 177-224.
- Portner, P. 2004. The semantics of imperatives within a theory of clause types. Talk delivered SALT 14, Northwestern University, June 2004.
- Portner, P. & R. Zanuttini. 2002. Form and Force in Grammatical Theory, presented at the workshop on The Syntax-Semantics Interface in the CP Domain, Zentrum für Allgemeine Sprachwissenschaft, Berlin, March 7, 2002.
- Potsdam, E. 1996. *Syntactic Issues in the English Imperative*. Ph.D. dissertation. University of California at Santa Cruz.
- Potts, C. 2003. Keeping world and will apart: A discourse-based semantics for imperatives, talk delivered at the NYU Syntax/Semantics Lecture Series, October 17, 2003. (Handout available at <http://www-unix.oit.umass.edu/%7Epotts/>)
- Rivero, M. L. & A. Terzi. 1995. Imperatives, V-movement and logical mood. *Journal of Linguistics*, **31**: 301-322.
- Sadock, J. M. and A. Zwicky. 1985. Speech act distinctions in syntax. In Shopen, T., ed., *Language Typology and Syntactic Description*. Cambridge: Cambridge University Press, 155-196.
- Shibatani, M. 1977. Grammatical relations and surface cases. *Language*, **53**: 780-809.
- Speas, M. 1995. Economy, Agreement and the Representation of Null Arguments, Manuscript. University of Massachusetts.
- Toribio, A. J. 1990. Specifier-head agreement in Japanese. *Proceedings of WCCFL*, **9**: 535-548.
- Whitman, John. 1989. Topic, Modality, and IP Structure. In Susumo Kuno et al. (eds.), *Harvard International Studies on Korean Linguistics*, **III**: 341-356. Hanshin. Seoul. Korea.

- Zanuttini, R. 2003. Imperative and Clause Types, talk delivered at the North American Syntax Conference, May 2-4, 2003.
- Zanuttini, R. & P. Portner. 2003. Exclamative Clauses: At the Syntax-Semantics Interface. *Language*, **79**.1: 39-81.

Miok D. Pak
Department of Linguistics
Georgetown University
37th & O Street, NW
Washington DC, 20057
pakm@georgetownn.edu

The Group Interpretation of Plural Indefinite Descriptions with *unos*

Helena López Palma
University of A Coruña

1. Introduction

It has been noticed that indefinite descriptions with the Spanish determiner *unos* (*a*PL, ‘some’) has a default group reading (Villalta 1994). That meaning has been explained within DRT (Gutiérrez Rexach 2001, Laca and Tasmowski 1996). *Unos* introduces a group variable in the discourse. However, the group meaning is unstable, and in some contexts, “*unos* NP” may have an individual reading too. We suggest that unstability is best understood as an epistemic fact. We propose an explanation of *unos* in terms of Kratzer’s version of a Skolem Choice Function. *Unos* is a Perspectival Choice Function that selects a unique sum of individuals and shifts it into a group. When the perspectival argument is free, “*unos* NP” denotes an indefinite group, which we dub a cluster. When it is anchored to the speaker, the content of the cluster is transparent and the individual reading may arise. We’ll begin by examining some crucial data, and after, we’ll consider some accounts that have been proposed to explain those facts.

Villalta (1994), Laca and Tasmowski (1996), and Gutiérrez Rexach (2001) have noticed that “*unos* NP” (“*a*PL NP”) differs from other indefinite determiners, such as cardinals or the existential plural quantifier *algunos* (‘some’), in that the indefinite description with *unos* denotes a plural referent that is interpreted as a unique plural individual, and not as a sum of atomic individuals. The following data supports their view:

a) “*Unos* NP” can not be subject of individual-level predicates that denote inherent properties of a class

- (1) *Unos gatos son animales inteligentes.
 *a*PL cats are animals intelligent
 ‘A group of cats are intelligent animals.’

- (2) *Unos cuadrados tienen cuatro lados.
 aPL squares have four sides
 ‘A group of squares have four sides.’

b) “*Unos NP*” can not be interpreted as the Range Phrase (Safir and Stowell 1988) of a binominal distributive construction (3), or the antecedent of the distributive numeral *sendos* (‘one each’) (4):

- (3) *Unos marineros durmieron cada uno en una cama diferente.
 aPL sailors slept each one in a bed different
 ‘A group of sailors slept each in a different bed.’

- (4) *Unos/cuatro pastores han comprado sendas ovejas.
 aPL/four shepherds have bought NUMDIST sheep
 ‘A group of/four shepherds have bought one sheep each.’

c) “*Unos NP*” can not be the antecedent of a reflexive or reciprocal pronoun:

- (5) *Unos pasajeros se miraban a sí mismos.
 aPL passengers SE lookIMP.PAS to themselves
 ‘A group of passengers were looking at themselves.’

- (6) *Unos pasajeros se miraban unos a otros.
 aPL passengers SE lookIPM.PAS aPL at others
 ‘A group of passengers were looking at one another.’

d) “*Unos NP*” can be subject or object of predicates that subcategorize for those functions DP arguments with a collective interpretation (*rodear* surround, *amontonar* pile, *reunirse* meet, *juntarse* gather):

- (7) Unas hormigas rodeaban el pastel.
 aPL ants surroundIMP.PAS the cake
 ‘A group of ants were surrounding the cake.’

- (8) Los marineros amontonaron unas cajas en el muelle.
 The sailors piled aPL boxes in the docks

In sum, “*unos NP*” seems to introduce a plural variable that has the meaning of a plural individual or group. Its referent is not interpreted as a sum of atomic individuals, and hence the atomic entities of the plural variable are not accessible to syntactic operations.

How does the plural variable obtain its group meaning? Where does that value lie? What does it depend on? Suppose we attribute the group meaning to a lexical feature of the indefinite determiner. That is the view of Villalta (1994), who analyzes *unos* as a “group marker”, and Gutiérrez Rexach (2001), who proposes that *unos* is a “collectivizer”. *Unos* could be then interpreted as ‘a group of some’. Perhaps such interpretation could be influenced to the feature ‘unicity’ that both singular *un* (‘a’) and plural *unos* (‘aPL’) share. However, this hypothesis encounters some counter-examples: in several contexts, “*unos NP*” can also have a distributive reading:

a) Stage-level predicates: “*unos NP*” can be the subject of stage-level predicates that describe an inherently individual action (*dormir* ‘sleep’, *cantar* ‘sing’, *nacer* ‘be born’, *caminar* ‘walk’):

- (9) *Unos gatos duermen en el jardín.*
 aPL cats sleep in the garden
 ‘A group of cats are sleeping in the garden.’

b) Contrastive topic contexts: we also obtain the individual reading in contrastive topic contexts:

- (10) *Unos gatos son negros, otros son blancos.*
 aPL cats are black, others are white.’
 ‘A group of cats are black, others are white.’

c) Furthermore, “*unos NP*” with a relative sentence complement can be the range phrase of a binominal distributive construction:

- (11) a.**Unas llaves abren cada una una puerta.*
 aPL keys open each one one door
 ‘A group of keys open each a door.’
 b. *Unas llaves que compré ayer abren cada una una puerta*
 aPL keys that I bought yesterday open each one a door
 distinta del coche.
 different of the car
 ‘A group of keys I bought yesterday open each a different door of the car.’

d) “*Unos cuantos NP*” (‘*some many NP-PL*’) has not the meaning of a plural individual, but it can either be interpreted distributively or collectively:

- (12) *Unos cuantos invitados se comieron un plato de jamón cada uno.*

aPL many guests SE eat a plate of ham each one

In sum, the group reading denoted by “*unos* NP” is unstable. How can we explain the contradictory data? How is the group meaning obtained? How do we get the distributive interpretation?

3. An epistemic proposal for the group denotation of “*unos* NP”. *Unos* is a perspectival group choice function

We suggest that one way to deal with the unstable interpretation of “*unos* NP” is to analyze the determiner *unos* as a perspectival choice function. Such an analysis will enable us to show the role of contextual saliency, the influence of the restrictor, or the effect that the structure of the information has on the meaning of “*unos* NP”.

A choice function is a partial function that takes as its argument a set of individuals among which it selects a unique element of the set. Hence, a choice function is of type $\langle\langle e, t \rangle, e \rangle$. In the model proposed by Reinhart (1997) certain indefinite determiners are pronominal elements that may introduce variables over choice functions. Take, for instance, the sentence

(13) Some cat meows.

The sentence above can be interpreted as an existential statement about a choice function variable, f . The choice function variable takes the predicate *cat*’ and returns an individual, *some cat*, which denotes ‘the unique cat’ that f selects from the domain of cats. That is, *some cat* is interpreted as:

(14) $f(\text{cat}')$

where f is a variable ranging over choice functions, and the individual picked by the choice function is in the extension of the predicate *meows*’. In the model of Reinhart, the choice function variable is closed by an existential operator, which is inserted at whatever node the indefinite is interpreted. The meaning of sentence (13) could be represented as (15), and its syntactic representation could be (16):

(15) $\exists f[\text{CHOICE}(f) \ \& \ \text{meows}'(f(\text{cat}'))]$

(16) $\exists f[\text{some cat}_t \ \text{meows}]$

In (16), *some cat* remains *in situ* and there is an existential operator with sentential scope that binds the function variable, and contributes with the existential force.

Kratzer argues that such version of a choice function can not explain how indefinites get dependent readings. She proposes that a Skolem Choice Function can do that. Let us see how. A Skolem Choice Function has two arguments: a predicate denoted by the noun that is combined with the indefinite determiner, and an implicit argument variable. In the sentences below:

- (17) Every professor rewarded every student who read a book she had recommended.
 (18) Every professor rewarded every student who read a book I recommended.

The indefinite *a book* could be represented as a Skolem Choice Function Variable:

- (19) $f(x, \text{book})$

In sentence (17), the interpretation of *a book* depends on the interpretation of *every professor*. To represent that quantifier dependency we get the implicit argument bound by the quantifier phrase *every professor*. On the other hand, in sentence (18), the presence of the first person pronoun contributes to make salient the reference of the indefinite. We can represent that meaning treating the implicit argument variable x as a perspectival argument that expresses contextual dependencies on the speaker.¹ In what follows, we'll propose to analyze *unos* as a perspectival choice function. We'll show that such an analysis succeeds in capturing number dependencies, pronominal dependencies and contextual saliency.

2.1. Arguments in favor of *unos* as a perspectival choice function

In this section we'll apply the perspectival choice function analysis to represent the group meaning of "*unos NP*". Let us consider the following simple sentence:

- (20) Cada violinista interpretó unas variaciones.
 Every violinist played aPL variations

If we apply a perspectival choice function analysis to *unas variaciones* (aPL variations), that plural indefinite description can be represented as in

- (21) $f(x, *variation')$

(21) says that *unos* is a choice function that takes an individual x , and a nominal predicate denoting a non-empty set of plural individuals (**variation'*), and

yields a unique group member of the set. That is, “ f_x (*variation)’” expresses that the property of being a group of variations X is instantiated by the unique plural individual chosen by the perspectival choice function (*unas*). We propose that a possible syntactic representation could be like the one below:

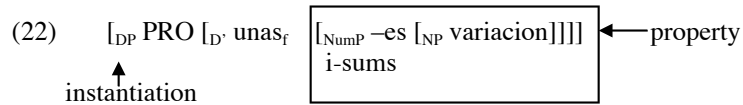

PRO, in the specifier of DP, represents the implicit argument of the choice function, while *unos* is in the head of DP.

The unmarked interpretation of the plural individual denoted by *unas variaciones* is that of a group. In sentence (20), that group can have three interpretations: a functional reading, a non-dependent non-specific reading, and a non-dependent specific one.

In the functional reading, the implicit variable is parameterized to the universal quantifier phrase *cada violinista*, and *unas variaciones* is interpreted as the share of the distributive range denoted by *cada violinista*. That meaning could be paraphrased by:

- (23) ‘Cada violinista interpretó unas variaciones que ella misma eligió.’
 Every violinist played aPL variations that she same chose

and that interpretation is captured by the parameterized implicit argument:

- (24) Cada violinista (x) [x interpretó $f(x, \text{*variación})$]

In the non-dependent non-specific reading, the interpretation of *unas variaciones* doesn’t depend on *cada violinista*. *Unas variaciones* remains unspecific, and the share of the distributive range *cada violinista* is the entire predicate. This meaning is captured by (25), where the implicit argument is left free:

- (25) Cada violinista (x) [x interpretó $f(y, \text{*variación})$]

In the no-dependent specific reading, *unas variaciones* denotes a specific referent. As before, the share is the entire predicate. This meaning could be paraphrased as ‘Every violinist played some variations that I chose’, and it is represented in (26), where the implicit argument of the choice function variable is parameterized to the speaker:

(26) Cada violinista (x) [x interpretó f (*speaker*, *variación*)]

In sum, the use of perspectival choice functions to represent the group meaning of “*unos NP*” offers the following advantages: (a) It enable us to formalice contextual saliency. (b) It enables us to represent different kinds of dependencies.

3. The nature of the group interpretation of “*unos NP*”

What are the semantic properties of the group described by “*unos NP*”? We saw that *unos* is a perspectival choice function that assigns a group interpretation to the plural individual chosen by the function among the plural individuals of a join semi-lattice. However, we still haven’t explained why is this group interpretation unstable. In this setion we’ll start by reconsidering what is a group. Our semantic account will be based on Link (1984).

Nominal expressions denoting plural individuals have been dubbed by different terms such as pluralities, bunches, groups, sums, collections. (Link 1983, 1984, Lasersohn 1995, Landman 1989, etc.) Link (1984) proposes an ontology of plurals in which he distinguishes two types of plural nominal entities: (a) Sums, which are structured collections of atomic entities that have a transparent part structure; and (b) Groups, which are opaque entities with regard to their part structure.

Sums are built from atoms by the star operator (*cat’). A group is an ontological entity that is obtained from a sum. In Link’s model (1984), and in Landman’s (1989), a group is a function that takes a sum of atoms and yields a plural individual. The operator of group formation \uparrow erases the part structure of the sum. So a group is a sum shifted into an atom, and it may have the same definition as individual atomic entities:

(27) An entity x is atomic iff $\forall y [y \leq x \rightarrow y = x]$

For instance, suppose we have a sum of two cats, Kit and Kat:

(28) $\text{kit} \oplus \text{kat}$

This sum has a transparent part structure, and we may have access to the individual atoms. Thus, the coordinated proper nouns can be subject of a distributive predicate, for example

(29) Kit and Kat ate a sardine each.

We, then, can shift this sum into a group:

$$(30) \quad \uparrow(\text{kit} \oplus \text{kat})$$

In that expression, the part structure has been erased, and the coordinated proper nouns may be the subject of a collective predicate.

$$(31) \quad \text{Kit and Kat gathered in the garden.}$$

Link also applies the star operator to verbs. For instance, the sentence *Kit and Kat are sleeping*, interpreted with a distributive reading as a plurality of events of sleeping performed by Kit and Kat, could be represented as

$$(32) \quad *'sleep' (\text{kit} \oplus \text{kat})$$

On the other hand, the collective interpretation of the same sentence, in which Kit and Kat form a group, would be represented as

$$(33) \quad 'sleep' \uparrow(\text{kit} \oplus \text{kat})$$

the predicate *sleep* is not pluralized, because the group is interpreted as an atom.

How do we build a group with plural indefinite descriptions with *unos*? “*Unos NP*” achieves its group meaning in the following way: First, the star operator takes the atomic individuals of a set and yields plural individuals that are sums (**cat*). Those sums have the property of cumulative reference. Then, the choice function *unos* selects one of such sums and assigns it a group interpretation:

$$(34) \quad \text{unos}_x (*'cat')$$

That group has no parts and we can't identify the atoms from which it is built: The atoms are not accessible not only to distributive operators (*cada uno por separado*, ‘each one separately’), but also to collective ones. Thus, “*unos NP*” can't be modified by *juntos* (‘together’), *a la vez*, *al mismo tiempo* (‘at the same time’), *al unísono*, *a la par*, *conjuntamente* (‘conjointly’)

$$(35) \quad *'Unos estudiantes han levantado juntos \quad \text{el piano.}$$

aPL students have lifted together the piano

Apart from having an opaque part structure, are there any characteristics in the group denoted by “*unos NP*” that makes it different from the group denoted by collective nouns like *el departamento* (‘the department’)? “*Unos NP*” describes an indefinite group. We can't access to the atoms because they are not well

identified, for whatever reason that may be. The speaker is vague when referring to the group, and we perceive it as a blurred bunch of entities involved in a common event. We do not know the quantity of entities that make the group, and we can't identify the individual members. We will call that fuzzy group a cluster. But the group denoted by “*unos NP*” differs from the one denoted by ‘the department’ in that the first one can become transparent.

4. Getting the distributive meaning of “*unos NP*”

A cluster can become transparent, and its atoms can be accessible to syntactic operations if the speaker gives a sufficiently rich description of the cluster that would enable him to individuate the atoms. The marked distributive reading may be obtained when the indefinite has a specific interpretation, which can be favored by: the deictic interpretation of tense, the informative structure, the syntactic structure (internal vs. external subjects), or by the presence of identifying nominal modifiers like a relative sentence complement, or an adjective.

4.1. The interpretation of tense

Stage-level verbs like *dormir* (sleep), *cantar* (sing), *nacer* (be born), *morir* (die) are distributive verbs that select an atomic individual denoting subject. However, that selectional restriction does not prevent those verbs from combining with the group denoting indefinite description “*unos NP*”

- (9) Unos gatos duermen en el jardín.
 aPL cats sleep in the garden

Before we assumed that in those cases, the lexical meaning of the verb forces a distributive reading in “*unos NP*”. However, it is wrong to draw such conclusion, because the distributive reading of “*unos NP*” is not the only interpretation the indefinite may have in sentence (9). “*Unos NP*” has also a cluster reading in the habitual interpretation of the present tense. We argue that the cluster reading is the default interpretation of “*unos NP*” in those sentences. The distributive meaning is a marked interpretation we obtain when the tense of the verb is deictically anchored. Let's take first the habitual reading of sentence (9)

- (36) Unos gatos duermen cada día en el jardín.
 aPL cats sleep every day in the garden

Even though the verb lexically selects an individual subject, the sentence seems to express a single event performed by a group of cats, which is existentially

quantified, rather than a plurality of events. Such event is then interpreted inside of the scope of the habitual adverbial quantifier expression *cada día* (every day), and it is precisely that adverbial quantifier what gives a plural meaning to the event. Thus, the sentence could be paraphrased as “For every day, there is an event of sleeping aPL cats in the garden”:

- (37) Para cada día $\exists e$ [dormir unos gatos en el jardín (e)]
 ‘For every day $\exists e$ [sleep aPL cats in the garden (e)]’

Suppose we include in the sentence an indefinite description that could function as a distributive share (*en un rincón*, ‘in a part’):

- (38) Unos gatos duermen en un rincón del jardín cada día.
 aPL cats sleep in a part of-the garden every day

In such case, the indefinite *en un rincón* establishes a distributive relation with the habitual adverbial quantifier, and it does not take *unos gatos* as the range for distribution. Here also, “*unos NP*” has a group interpretation:

- (39) ‘El dormir unos gatos en el jardín ocurre en una parte distinta cada día.’
 ‘The event of sleeping aPL cats in the garden occurs every day on a different part of the garden.’

Therefore, in its habitual reading, the event of sleeping aPL cats described in sentence (36) has a meaning that could be represented as

- (40) Sleep ($f(*cat')$)

Where sleeping is seen as a single collective event performed by a group of cats.

Let’s now consider the interpretation anchored to the time of utterance of (9), which is expressed unambiguously by the continuous tense or by the Spanish imperfect:

- (41) a. Unos gatos están durmiendo en el jardín.
 aPL cats are sleeping in the garden.
 b. Unos niños dormían en el jardín.
 aPL children sleepIMP.PAS in the garden

“*Unos NP*” can be the range of a distributive relation:

- (42) Unos gatos están durmiendo en un rincón del jardín cada uno.

aPL cats are sleeping in a part of the garden each one

The sentence above describes a plurality of events performed by the individual cats of a group. Such meaning can be formalized as:

(43) *sleep ($\downarrow f(x, \text{cat}')$)

the cluster denoting indefinite description *unos gatos* is shifted into an i-sum by the individualizing operator \downarrow .

How can we explain the difference in the interpretation of “*unos NP*” in the sentence with the habitual and with the actual reading of the present tense? How do we obtain the cluster and the distributive meaning of “*unos NP*”? The distributive verb *sleep* selects an atomic individual subject, but it is not an anti-collective predicate. Therefore, the sentence may denote an instantiation of a single event of a group of individuals that are all gathered at the same place, performing the same action at the same time. As “*unos (x, *gato)*” establishes a group unit, the collective meaning is the one obtained in the unmarked interpretation. But if we anchor the time of the event to the time of the speech act, the implicit argument of the choice function is identified by the context and the individual atoms of the group denoted by “*unos NP*” are accessible:

(44) $\exists e[\text{*sleep_in_the_garden} (\downarrow f(x^{\text{NOW}}, \text{*cat}))(e) \ \& \ \text{NOW} \subseteq e]$

Thus, the individual reading we observed in (9) (*Unos gatos duermen en el jardín.*) is not a property of the lexical verb itself but of the deictic tense.

4.2. Identifying modifiers

The co-occurrence of “*unos NP*” with identifying modifiers favors the distributive interpretation of the group. Thus, when “*unos NP*” is combined with some adjectives, or relative sentences with the verb in indicative, that contribute to make the indefinite group become specific, the cluster denoted by the plural indefinite can be shifted into an i-sum, and the indefinite group may have a distributive reading. Some of those adjectives include prenominal *ciertos* (‘certain’), *determinados* (‘determined’), *conocidos* (‘known’), *famosos* (‘famous’), etc. Bosque (2001) studies the specifying effect in indefinites of those kinds of adjectives. We illustrate that property of identifying modifiers in the sentences below:

(45) Unos conocidos lingüistas defendían posturas distintas.
aPL known linguists defended different points of view

- (46) Unos transportistas que contraté ayer subieron cada uno un piano de cola por las escaleras.
 ‘Some specialized carriers whom I hired yesterday brought upstairs a grand piano each.’

4.3. The structure of the information

The structure of the information conveyed by the sentence has an effect on the interpretation of indefinites. Villalta (1994), Laca and Tasmowski (1996) and Gutierrez Rexach (2001) noticed that when “*unos NP*” is contrasted in the discourse with *otros* (‘others’), the plural indefinite description can be the subject of an individual level predicate:

- (47) Unos gatos son negros, otros son blancos.
 aPL cats are black, others are white
- (48) *Unos gatos son negros.
 aPL cats are black

Why is sentence (47) acceptable while (48) is not? Such difference in acceptability judgments that puzzled us in section 1 seems, then, to be related to the structure of the information, and not to the lexical meaning of *unos*.² For the sentence (48) to be acceptable, we need to contrast the group denoted by “*unos NP*” with some other group(s) belonging to the same class. That is, “*unos NP*” can be the subject of an individual-level predicate, if it is interpreted as a contrastive topic and not just as a topic:

- (49) [Unos gatos_{CT}] son negros, [otros X_{CT}] son blancos.

A contrastive topic³ presupposes a class of alternatives that the speaker wants to talk about. In the sentence above, the plural noun “cats” is perceived as a contrast class (Bird 2001) that is considered from the point of view of its subsets of i-sums. The two partial i-sums “aPL cats...others”, are compared with respect to the property of their color, and the sentence “aPL cats are black” is just one of the possible alternatives. Such a meaning could be paraphrased as “Considering all relevant cats, for the property of color C, I believe that aPL cats are black, and others are white”. And the meaning of sentence (89) could be represented as:

- (50) $\forall X \subset \text{*cat}' \lambda C [C \text{ is a color} \ \& \ C (\downarrow(f(\text{speaker}, X)) \ \& \ C (\downarrow(g(\text{speaker}, X)))]$

The alternatives presupposed in the sentence with “*unos...otros*” refer to the identity of the groups, and not to the number of atoms in each group. The meaning of *otros gatos* (‘other cats’) can be paraphrased as “different cats from

the ones previously mentioned”. We analyze the plural determiner *otros* as a function that selects as its argument an i-sum, different from the one(s) already mentioned and included in the whole contrast class.

Conclusions

“*Unos NP*” denotes, in the unmarked reading, a plural individual referent. The group meaning is contributed by the indefinite determiner *unos*.

The determiner *unos* is a perspectival choice function that takes an implicit argument and a set of sums of individuals among which it selects a unique sum of individuals. *Unos* is also a group operator that shifts the sum of individuals into a group.

“*Unos NP*” does not have a collective meaning in which the group is interpreted as an aggregation of individual atoms. In the unmarked reading, “*unos NP*” denotes a fuzzy group, which we dub a cluster. We suggest that a cluster is a group that is coarsely perceived by the speaker. As a result the cluster is interpreted as a group with an opaque part structure.

“*Unos NP*” may have a distributive reading when the indefinite description has a specific interpretation. In that case, the speaker has a more detailed epistemical perception of the group and its parts, and the syntactic operations may have access to the atoms of the cluster.

Using a perspectival choice function analysis for *unos* enables us to explain the epistemic nature of the cluster. Furthermore, we can represent contextual saliency, and pronominal and numeral dependencies.

References

- BEYSSADE Claire and Carmen DOBROVIE-SORIN. 2005. *Définir les indéfinis*. Paris, CNRS Editions.
- BIRD, Alexander. 2001. “Scepticism and Contrast Classes”, *Analysis*, **61**: 97-107.
- BORER, Hagit. 2005. *In name only*. Oxford, Oxford University Press.
- BOSQUE, Ignacio. 2001. “Adjective Position and the Interpretation of Indefinites”, in J. Gutierrez Rexach and L. Silva Villar (eds.) *Current Issues in Spanish Syntax and Semantics*. Berlin: De Gruyter: 17-38.
- CHIERCHIA, Gennaro. 2001. “A Puzzle about Indefinites”, Carlo Cecchetto et al. (eds.) *Semantic Interfaces. Reference, Anaphora and Aspect*. Stanford: CSLI Publications: 51-89.

- DEMONTE, Violeta. 2004. "Merge of Adjectives in DP". WECOL. LA, November 12-14.
- GUTIERREZ REXACH, Javier. 2001. "The semantics of Spanish plural existential determiners and the dynamics of judgment types", *Probus* **13**: 113-154.
- HEIM, Irene. 1982. The semantics of Definite and Indefinite Noun Phrases. PhD diss. UMass.
- KRATZER, Angelika. 1998. "Scope or Pseudo-Scope? Are there wide-Scope Indefinites?", in S. Rothstein (ed.) *Events in Grammar*. Dordrecht: Kluwer: 163-196.
- KRIFKA, Manfred. 1999. "Additive Particles under Stress", in *Proceedings of SALT 8*. Cornell.
- LACA, Brenda and TASMOWSKI, Liliane. 1996. "Indefini et quantification", in *Recherches Linguistiques de Vincennes*, **25**: 107-128
- LANDMAN, Fred. 2004. *Indefinites and the Type of Sets*. Oxford: Blackwell.
- LASERSON, Peter. 1995. *Plurality, Conjunction and Events*. Dordrecht: Kluwer.
- LINK, Godehard. 1983. "The logical analysis of plural and mass terms: a lattice-theoretical approach", in *Meaning, Use, and Interpretation of Language*. R. Bäuerle et al. (eds.). Berlin: Walter de Gruyter: 302-323.
- LINK, Godehard. 1984. "Hydras. On the logic of relative clauses constructions with multiple heads", in F. Landmann and F. Feltmann (eds.) *Varieties of Formal Semantics*. Dordrecht: Foris. Also in G. Link *Algebraic Semantics in Language and Philosophy*. Stanford: CSLI Pub. 1998.
- McNALLY, Louise. 1998. "Existential Sentences without Existential Quantification", *Linguistics and Philosophy*, **21**: 353-392.
- PARTEE, Barbara. 1989. "Binding Implicit Variables in Quantified Contexts", *CLS* **25**: 342-365.
- REINHART, Tania. 1997. "Quantifier Scope: How Labor is divided between Quantifier Raising and Choice-Functions", *Linguistics and Philosophy* **20**: 335-397.
- SAFIR, Kent and Tim STOWELL. 1989. "Binominal each" *Proceedings of NELS*, **18**: 426-450.
- SELKIRK, Elisabeth. 1984. *Phonology and Syntax: The Relation between Sound and Structure*. Cambridge, MA: The MIT Press.
- VERGNAUD, Jean Roger and María Luisa ZUBIZARRETA. 1992. "The Indefinite and the Definite Determiner and the Inalienable Constructions in Frech and English", *Linguistic Inquiry*, **23**. 4: 594-652.
- VILLALTA, Elisabeth. 1994. "Plural indefinites in Spanish and distributivity". ms Univ. Paris 7.

Notes

¹ In Chierchia's opinion (2001:55), we could think of the implicit perspectival argument as a null pronominal. As with overt pronouns, the null pronominal can remain free. Its value may, then, be fixed by the context of utterance. Also, the null pronominal may be bound by a c-commanding quantified NP, and then it behaves as a bound variable.

² Topicalization of the indefinite description is not enough to make the cluster transparent, as the sentence below seem to show:

- (i) a. ??[ÚnosTopic] gatos son negros.
- b. ??Unos [gátosTopic] son negros.
- c. ??[Únos gátosTopic] son negros.

³ For the notion of contrastive topic we assume the alternatives hypothesis developed in Krifka (1999).

The Rise of the Suffixal Article in the Early North Germanic DP*

Dorian Roehrs & Christopher D. Sapp

Indiana University

1. Introduction

This paper makes three main claims. First, we argue that demonstratives are phrases. With this in mind, we propose that the early North Germanic sequence “noun + demonstrative” provides evidence for a low article phrase (artP). Finally, we argue that the suffixal article arose from the demonstrative via reanalysis of a phrase (in Spec,XP) to a head (in X⁰).

2. Word Order Possibilities of Demonstratives and Articles

In this section, we illustrate attested word orders of the demonstratives and articles with regard to the head noun in three stages of early Scandinavian.

2.1 Proto-Scandinavian

Proto-Scandinavian is attested in runic inscriptions in the Elder Futhark (2nd-8th centuries). In these inscriptions, there are two demonstratives: *sá* and *hinn*. The demonstrative may precede N, regardless of whether it is *sá* (1a) or *hinn* (1b):¹

- | | | | |
|-----|----|-------------------------------------|------------------|
| (1) | a. | þat azina
this stone-slab | (By, RāF 71) |
| | b. | a hitt lant
to this land | (Eggja; RāF 101) |

However, the demonstrative may also follow N, both with *sá* (2a) and *hinn* (2b):

- | | | | |
|-----|----|-----------------------------------|------------------|
| (2) | a. | runaz þaiaz
runes these | (Istaby, RāF 98) |
| | b. | hali hino
stone this | (Strøm, RāF 50) |

Neither of these orders is dominant: the entire corpus consists of four examples of dem-N and three of N-dem.

2.2 Common Scandinavian

After the 9th century, the North Germanic runic inscriptions are in a different alphabet (the Younger Futhark), and there are many more inscriptions. By this stage, there are three types of demonstratives: the old *sá*, which is now the distal demonstrative ('that'), *sási/þessi*, a strengthened form of *sá* with the local meaning ('this'), and *hinn*.

By this period, the order N-dem has reached 98% for *sási/þessi*, whereas *sá* is too scantily attested to draw any conclusions (Perridon 1996:252). On the other hand, (*h*)*inn* seems to be well on the way to becoming a determiner. At the beginning of this period, it never occurs in a simple DP, but is found only when an adjective is present. Compare (3a) and (3b), where the determiner in (3b) is suffixed to the head noun:

- (3) a. **kunar ... lit kiara mirki fr sial ...** (Uppland 312)
 Gunnar ... let make monument for soul ...
 'Gunnar ... had (the) monument made for (the) soul ...'
 b. **tati iok ... mirki-t mikla eftiR faður sin** (Södermanland 41)
 Tate cut ... monument-the big after father his
 'Tate carved the big monument in memory of his father'

Many instances of (*h*)*inn* occur with an inherently uniquely referring element, here a proper name:

- (4) a. **in heilhi kristr** (Södermanland 125)
 the holy Christ
 b. **kristr hin helgi** (Uppland 391)
 Christ the holy

This shows that in some cases, (*h*)*inn* has lost its deictic force as a demonstrative and may now have properties of an expletive, in that it seems to have a purely syntactic function in (4). Free-standing, postnominal (*h*)*inn* as in (4b) presumably formed the basis for the suffixed determiner as in (3b).

In the 11th century (cf. Noreen 1970:316), we find the first attestation of the article *hinn* with no adjective:

- (5) **kuþ hialbi ant-ini** (Uppland 669)
 god help soul-the (Wessén 1970:30)

Crucially, the article is in suffixal form, suggesting it originated in phrases like (3b).

2.3 Old Icelandic

Old Icelandic (13th-15th centuries) is directly descended from Common Scandinavian. It has reversed the relative order of the noun and the demonstrative: *sá* and *þessi* usually appear as dem-N. As for *(h)inn*, it has split into two distinct functions. The first is the determiner, no longer having deictic force. When an adjective is present, the determiner occurs pre-adjectivally (6a-c); when there is no adjective, the determiner appears as a post-nominal clitic (6d). The second function of *(h)inn* is as a demonstrative, where it can appear in a position not available to the definite article, i.e. directly before the noun, as in (6e). Furthermore, it can occur before the adjective, as in (6c). In other words, *(h)inn* in (6c) is ambiguous between an article and a demonstrative:

- (6) a. maðr-inn gamli
man-the old
b. maðr (h)inn gamli
c. (h)inn gamli maðr
d. maðr-inn
e. (h)inn maðr

2.4 Schematic summary

To summarize the developmental path, the demonstrative *hinn* gradually evolved into a definite article, as shown in Table 1. Only a demonstrative in Proto-Scandinavian, the first clear instances of *(h)inn* as an article occur in modified DPs in Common Scandinavian. Besides this use, we also find the article suffixed to unmodified DPs in Old Icelandic.

Table 1: Kinds of demonstratives and articles in early North Germanic

Language	Demonstrative	Article
Proto-Scandinavian	<i>sá, hinn</i>	-
Common Scandinavian	<i>sá, þessi</i>	<i>(h)inn</i> (before adjectives)
Old Icelandic	<i>sá, þessi, (h)inn</i>	<i>(h)inn</i> (before adjectives) and <i>-inn</i> (clitic)

Note that *(h)inn* is not attested in Common Scandinavian as a demonstrative in unmodified DPs. However, considering that demonstrative *hinn* occurs in Old Icelandic and the probability that the grammaticalization channel “demonstrative > article” is irreversible, we believe that it must have existed in Common Scandinavian as well (see also footnote 4).

Table 2 summarizes the possible positions of the demonstratives and definite articles in the various stages for the unmodified DP. After an equal distribution in Proto-Scandinavian, Common Scandinavian shows a clear preference for N-dem. In the latter language, we begin to find the first clear instances of articles. With the completed development of the definite article in Old Icelandic, a

division of labor seems to have developed in the simple DP between the pre-nominal position used by the demonstrative (reversing the Common Scandinavian preference) and the post-nominal position used by the article.

Table 2: Position of demonstratives and articles in early North Germanic

Language		Dem - N	N - Dem
Proto-Scandinavian		+	+
Common Scandinavian		few	+
Old Icelandic	<i>sá, þessi</i>	+	few
	<i>(h)inn</i>	+ (demonstrative)	+ (clitic article)

3. Formalizing the Development of the Suffixed Article

In this section, we provide evidence that demonstratives are phrases, and as such they are assumed to be in Spec positions. Next, considering the order N-dem, we discuss three potential analyses, concluding that the demonstrative is base-generated in a lower Spec position. Then, we suggest that N-dem forms the basis of the reanalysis of the demonstrative in the Spec position to a suffixed article in a head position. Finally, we briefly discuss some advantages and consequences of our proposal and the question why only *hinn* became the suffixed article.

3.1 Demonstratives are phrases

Among many others, Brugè (1996), Campbell (1996), van Gelderen (2004), Giusti (1997), and Panagiotidis (2000) argue that demonstratives are phrases and thus in Spec positions. We provide one further argument for this claim with evidence from some Scandinavian dialects.

To begin with, pre-nominal possessives are sometimes argued to be in Spec,DP. One argument in favor of this claim is the possibility that they may co-occur with a determiner:

- (7) a. minn inn hvassi hjórr (Old Icelandic)
 my the sharp sword (Wessén 1970:49)
 b. mett te stór húse (Lappräsk Sw.)
 my the big house-the (Vangsnæs 1999:157)

Assuming that the definite article is in D and that D can host at most one overt element, we conclude that the possessives must be in Spec,DP.

Interestingly, demonstratives may also co-occur with a determiner:

- (8) a. {sá / siá / þesse} enn gamle maþr (Old Icelandic)
 that / this / this the old man (Heusler 1932:126)
 b. tetta (te) stór húse mett (Lappräsk Sw.)
 this (the) big house-the my (Vangsnæs 1999:158)

On par with (7), we propose that demonstratives are also in Spec,DP. As Spec,DP is a phrasal position, we conclude that demonstratives are phrases.

3.2 Three options to derive the order N-Dem

In the previous section, we argued that demonstratives are in phrasal positions. In section 2, we illustrated that demonstratives can appear both before and after the head noun in Proto-Scandinavian. This then raises the question how the order N-dem is to be analyzed: one could assume that either the demonstrative is in a different base-position, the head noun N (as part of an XP) moves across the demonstrative, or both. In what follows, we discuss three options, concluding that the base position of the demonstrative is not in Spec,DP but lower in the structure.

As a first option, one could assume that the demonstrative is in Spec,DP and that this Spec position is on the right:

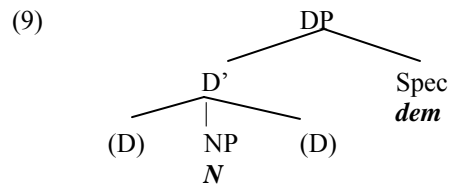

However, following Kayne (1994), we assume that specifiers on the right are universally disallowed, thus concluding that this option is not available. Likewise, we assume that right adjunction of the demonstrative to the noun phrase is universally disallowed.

As a second option, one could propose that the demonstrative is in Spec,DP and that this Spec position is on the left, as in most standard accounts (e.g. Abney 1987). In order to derive the order N-dem, one could suggest that the head noun contained in another phrase (XP) moves across Spec,DP to a higher position, illustrated here as Spec of ?P:

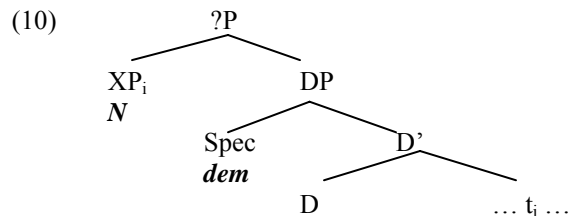

This option also presents a number of problems. Consider two scenarios, the first involving movement due to Scrambling, the second movement due to feature checking.

First, if ?P in (10) equals DP, then XP has moved to adjoin to DP, presumably by Scrambling. However, left adjunction to DP is a very “marked” option and is typically possible only with demonstratives (cf. Norwegian *denne min utbrukte sko* ‘this my worn-out shoe’, Hellan 1986:104). Furthermore, the type of adjunction in question here would involve *movement* to adjoin to an argument, banned by Chomsky (1986).² We conclude then that this option is not available either.

In the second scenario, ?P in (10) equals YP, an assumed phrase level in a split-DP (à la Rizzi’s 1997 split-CP). In this case, movement to Spec,YP is assumed to be driven by feature checking in Spec-head configurations, ruling out untriggered movements in general. Note now that the noun in the N-dem order is neither focused nor topicalized. Thus, it is not clear what feature the noun (as part of XP) would check in Spec,YP. If movement is only triggered by feature checking, we conclude that the noun cannot have moved to Spec,YP. Furthermore, there is some indication that (some of) the Scandinavian languages do not have split-DPs: Grohmann & Haegeman (2003) observe that, unlike West Flemish, Norwegian does not allow noun phrase-internal left dislocation or possessor-related Quantifier Float.

As a final option, we propose that the demonstrative is generated in a lower Spec position. Following Julien (2002) and Vangsnes (1999), we assume that determiners are merged in an article phrase (artP). In particular, we suggest that demonstratives are merged in Spec,artP (cf. Brugè 1996, Campbell 1996, Giusti 1997, Panagiotidis 2000, Vangsnes 1999:119-20). In order to derive the order N-dem, we propose that the demonstrative remains in situ and the head noun as part of a larger phrase moves to Spec,DP:

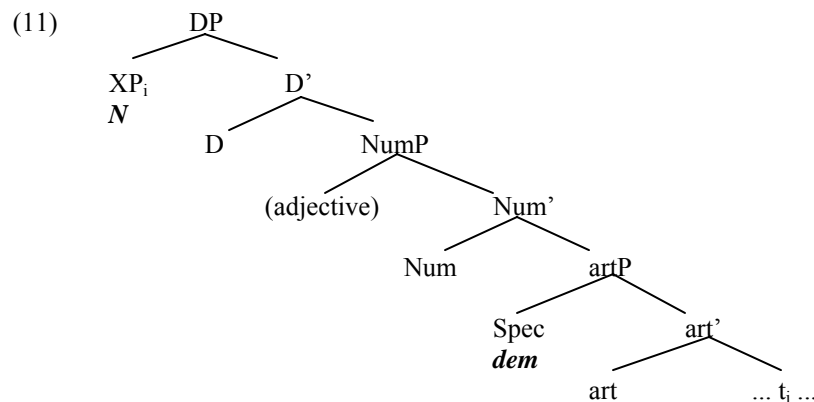

Following the traditional literature, we suggest that the resulting order N-dem forms the basis for the change from the post-nominal demonstrative to the suffixed definite article.

3.3 Reanalysis from demonstrative to article

In this section, we propose in more formal detail that the reanalysis of the demonstrative to the definite article progressed via several steps. At the same time, we illustrate the basic derivations for the data discussed above.

To set the stage, the Proto-Scandinavian examples motivate the lower position of the demonstrative. Assuming with Longobardi (1994) that referential noun phrases must have overtly licensed DPs, we suggest that Proto-Scandinavian had the option of moving either the demonstrative or the noun (as part of NP) to Spec,DP. The first option is provided in (12b) and the second one in (13b):

- (12) a. **a hitt lant**
to this land
b. $[_{DP} \text{hitt}_i D [_{artP} t_i \text{ art } [_{NP} \text{lant }]]]$
- (13) a. **hali hino**
stone this
b. $[_{DP} [_{NP} \text{hali }]_k D [_{artP} \text{hino art } t_k]]$

In Common Scandinavian, the determiner has become obligatory when an adjective occurs. It has a purely syntactic function with an inherently uniquely referring element, here the proper name *kristr*:

- (14) a. **in heilhi kristr**
the holy Christ
b. $[_{DP} \text{in}_i [_{NumP} \text{heilhi } [_{artP} t_i [_{NP} \text{kristr }]]]]$

Assuming then that the determiner is an expletive element, we propose that it has moved to D (rather than Spec,DP). If so, the phrasal demonstrative has been reanalyzed as a free-standing head determiner in (14).³

Next, in the course of the development from Common Scandinavian to Old Icelandic, the free article is suffixed to the head noun. Interestingly, as neither *hinn N* or *N hinn* sequences are attested in Common Scandinavian, suffixation must have resulted from the obligatory use of *hinn* with adjectives (as traditionally assumed).⁴ Note now that with *inn* a head in D, as suggested for (14), there is room in Spec,DP for the noun (phrase). Therefore, frequent appositives involving proper names as in (15a) could *potentially* be reanalyzed as part of the matrix DP as in (15b), where the head noun (inside NP) would have moved to Spec,DP (e_N indicates a null noun, see Panagiotidis 2002):⁵

- (15) a. $[_{DP} \text{kristr }] [_{DP} \text{hin}_i [_{NumP} \text{helgi } [_{artP} t_i [_{NP} e_N]]]]$
Christ the holy
b. $[_{DP} [_{NP} \text{kristr }]_k \text{hin}_i [_{NumP} \text{helgi } [_{artP} t_i t_k]]]$

(Note that at this stage, *hinn* is still a free-standing element as it still has initial ‘h’.) We suggest that this potential reanalysis paved the way for the *actual* reanalysis of less-frequent appositives involving common nouns. Concretely, with the loss of an intonational break between the head noun and the article, the head noun inside NP can be analyzed to be in Spec,DP and *hinn* in D. The article can then be suffixed to the head noun (“+” indicates suffixation):

- (16) a. **mirkit mikla**
monument-the great
b. [DP [NP **mirki**]_k +**t_i** [NumP **mikla** [artP t_i t_k]]]

Finally, although the first suffixed article without an adjective occurs in the 11th century (5), Old Icelandic still has free-standing and suffixed forms (6a-c):

- (17) a. [DP [NP **maðr**]_k+**inn_i** [NumP **gamli** [artP t_i t_k]]]
man the old
b. [DP [NP **maðr**]_k **inn_i** [NumP **gamli** [artP t_i t_k]]]
c. [DP **inn_i** [NumP **gamli** [artP t_i [NP **maðr**]]]]

This variation in Old Icelandic can be explained by two assumptions: (i) the article is still ambiguous between a free-standing and suffixal element, and (ii) NP movement to Spec,DP is optional. The first assumption explains the facts in (17a) and (17b) and the second one the contrast between (17a-b) and (17c).

3.4 Advantages and consequences

Importantly, the current proposal allows for a smooth change into Modern Icelandic. With the exception of literary Icelandic (*hinn gamli maður*), the determiner is now a suffixed form. We suggest then that over time, suffixation became obligatory and movement of NP was replaced by partial N-raising to art (cf. Taraldsen 1990) and subsequent movement of NumP to Spec,DP (cf. Julien 2002, Vangsnes 1999). Consider these two steps in the derivation:

- (18) a. ... [NumP **gamli** [artP **maður_k+inn** [NP t_k]]]
b. [DP [NumP **gamli** [artP **maður_k+inn** [NP t_k]]]]_j D ... t_j]

Another advantage is that the proposal of a lower artP fits well with other languages where demonstratives overtly surface in this position. This is illustrated for Spanish (Brugè 1996), Greek (Panagiotidis 2000), and the “marked” option in Modern Icelandic (Vangsnes 1999:148 fn. 34):

- (19) a. la reacción_i alemana **esta** t_i a las críticas (Spanish)
the reaction German this to the criticisms
‘this German reaction to criticism’

- (21) a. **kitils þis nuruna** (Egå)
of Ketil the Norwegian (Perridon 1996:258)
- b. þē gambla (Old Swedish)
hin gambla (Old Icelandic)
the old (Heusler 1932:125)

The reason then why only *hinn* became suffixed might be phonetic (cf. Nygaard 1905:34): besides the short stem vowel, *hinn* also had an ‘h’ as the initial consonant, which was prone to loss even when free standing (4a). (Cf. Kaisse 1981: 108, who notes that the ‘h’ on English relative pronouns is lost in rapid speech.)

4. Conclusion

Arguing that demonstratives are phrases, we concluded that the early North Germanic sequence “noun + demonstrative” provides evidence that demonstratives are generated in a low artP. Then, we argued that the phrasal demonstrative was reanalyzed as a head, giving rise to the suffixal article.

Notes

* We thank Kari Gade, Rex Sprouse, and the audience of WECOL 2004 for comments. All errors are each other’s. (For all academic purposes, Christopher D. Sapp is responsible for section 2 and Dorian Roehrs for section 3.)

¹ The examples in section 2.1 and 2.2 are taken from RāF (Krause and Jankuhn 1966) and *Södermanlands/Upplands Runinskrifter*. We follow the convention of transcribing the runic inscriptions with bold, lower-case letters. For clarity, we also use bold print for indicating the pronounced elements in the derivations in sections 3.3 and 3.4. Note that determiners and head nouns agree with regard to gender, case, and number, which we do not mark here.

² Further adjunctions to DP (e.g. of the demonstrative across the adjoined head noun inside XP) can presumably be ruled out by the requirement that a chain link must be at least of length 1 (where a chain link from A to B is of length n iff there is n “nodes” (X, X’, or XP, but not segments of these) that dominate A and exclude B).

³ There is independent evidence for the assumption that expletive determiners are in D (and not in Spec,DP). Longobardi (1994:623) argues that proper names in Italian must undergo N-to-D raising if an expletive determiner as in (ia) is not present. Compare (ib) to (ic):

- (i) a. il mio Gianni (Italian)
the my Gianni
- b. * mio Gianni
- c. Gianni mio
- d. il Gianni mio

Note that the possessive in (id) can only have contrastive reference. As discussed by Cardinaletti (1998), this possessive is in situ; the ones in (ia-b) are in a higher position and (ic) is presumably structurally ambiguous. Crucially, if we assume the expletive determiner to be in D, then the complementary distribution of this determiner and the raised proper noun in (ic) follows straightforwardly.

⁴ As already noted above, this state of affairs is surprising in view of the fact that Old Icelandic does have the demonstrative *hinn*. We believe that the reason these patterns are not attested has to do with the semantics of the demonstrative. Taking Old Icelandic as a guide where *hinn* means ‘the other’ or

‘(emphatic) that’ (Zoëga 1910), the use of *hinn* in inscriptions would probably be pragmatically odd. Although unattested and not usually assumed to have formed the basis for this reanalysis, the unmodified sequence N-dem could be a second scenario for this change and subsequent suffixation:

- (i) a. [DP [NP **maðr**]_i D [artP **hinn** [art' art t_i]]]
 b. [DP [NP **maðr**]_i D [artP [art' **inn** t_i]]]

To the extent that this possibility is correct, it would allow suffixation of *inn* in the DP-level (after movement of *inn* to D) or in the artP-level (after N(P) raising).

⁵ There is evidence that these structures, usually involving a proper name, did involve appositions: some material (indicated by italics) may intervene between the N and the apposition (Perridon 1996:257):

- (i) a. **Kara, faður sinn, inn malspaka** (Uppland 1146)
 Kara, father his, the eloquent
 b. ... **ok staf unnu(?) ok inn mikla at iarteknum** (Uppland 226)
 and staff made and the splendid as a sign of honor
 ‘...and made the staff, the splendid one, as a sign of honor’

References

- Abney, Steven. 1987. *The English Noun Phrase in its Sentential Aspect*. Doctoral Dissertation, MIT.
- Brugè, Laura. 1996. “Demonstrative movement in Spanish: A comparative approach”, *University of Venice Working Papers in Linguistics*, **6**, 1: 1-61.
- Campbell, Richard. 1996. “Specificity operators in Spec,DP”, *Studia Linguistica*, **50**, 2: 161-188.
- Cardinaletti, Anna. 1994. “On the internal structure of pronominal DPs”, *The Linguistic Review*, **11**: 195-219.
- Cardinaletti, Anna. 1998. “On the Deficient/Strong Opposition in Possessive Systems”, In Artemis Alexiadou & Chris Wilder (eds.) *Possessors, Predicates and Movement in the Determiner Phrase*, pp. 17-53. Amsterdam: John Benjamins Publishing Company.
- Cardinaletti, Anna & Michal Starke. 1999a. “The typology of structural deficiency: A case study of the three classes of pronouns”. In Henk van Riemsdijk (ed.) *Clitics in the Languages of Europe*, pp. 145-233. New York: Mouton de Gruyter.
- Cardinaletti, Anna & Michal Starke. 1999b. “Reply to Comments: Responses and Demonstratives”. In Henk van Riemsdijk (ed.) *Clitics in the Languages of Europe*, pp. 273-90. New York: Mouton de Gruyter.
- Chomsky, Noam. 1986. *Barriers*. Cambridge, Massachusetts: MIT Press.
- Chomsky, Noam. 1995. *Minimalist Program*. Cambridge, Massachusetts: MIT Press.
- van Gelderen, Elly. 2004. “Economy, Innovation, and Prescriptivism: From Spec to Head and Head to Head”, *Journal of Comparative Germanic Linguistics*, **7**: 59-98.
- Giusti, Giuliana. 1997. “The categorial status of determiners”. In Liliane Haegeman (ed.) *The New Comparative Syntax*, pp. 95-123. London and New York: Longman.
- Grohmann, Kleanthes K. & Liliane Haegeman. 2003. “Resuming Reflexives”, *Proceedings of the 19th Scandinavian Conference on Linguistics. Nordlyd*, **31**, 1: 46-62.
- Haspelmath, Martin. 1993. “The diachronic externalization of inflection”, *Linguistics*, **31**: 279-309.
- Hellan, Lars. 1986. “The Headedness of NPs in Norwegian”. In Pieter Muysken & Henk van Riemsdijk (eds.) *Features and Projections*, pp. 89-122. Dordrecht: Foris Publications.

- Heusler, Andreas. 1932. *Altisländisches Elementarbuch*. Heidelberg: Universitätsverlag Carl Winter.
- Hopper, Paul J. & Elizabeth Closs Traugott. 1993. *Grammaticalisation*. Cambridge: Cambridge University Press.
- Julien, Marit. 2002. "Determiners and Word Order in Scandinavian DPs", *Studia Linguistica*, **56**: 264-315.
- Kaisse, Ellen M. 1981. "Appositive Relatives and the Cliticization of *who*", *Chicago Linguistic Society*, **17**: 108-115.
- Kayne, Richard. 1994. *The Antisymmetry of Syntax*. Cambridge, Massachusetts: MIT Press.
- Longobardi, Giuseppe. 1994. "Reference and Proper Names: A Theory of N-Movement in Syntax and Logical Form", *Linguistic Inquiry*, **25**. 4: 609-665.
- Noreen, Adolf. 1970. *Altmordische Grammatik I*. Tübingen: Max Niemeyer Verlag.
- Nygaard, Marius. 1905. *Norrøn syntax*. Oslo: H. Aschehoug & Co.
- Panagiotidis, Phoevos. 2000. "Demonstrative determiners and operators: The case of Greek", *Lingua*, **110**: 717-742.
- Panagiotidis, Phoevos. 2002. *Pronouns, Clitics and Empty Nouns. 'Pronominality' and licensing in syntax*. Amsterdam: John Benjamins Publishing Company.
- Perridon, Harry. 1996. "Noun Phrases in Runic Swedish". In Kjartan G. Ottósson et al. (eds.) *The Nordic Languages and Modern Linguistics, vol. 9: Proceedings of The Ninth International Conference of Nordic and General Linguistics*, pp. 248-61. Oslo: Novus.
- Prokosch, Eduard. 1938. *A Comparative Germanic Grammar*. Baltimore: The Linguistic Society of America.
- RäF = Krause, Wolfgang und Herbert Jankuhn. 1966. *Die Runeninschriften im älteren Futhark*. Göttingen: Vandenhoeck und Ruprecht.
- Rizzi, Luigi. 1997. "The fine structure of the left periphery". In Liliane Haegeman (ed.) *Elements of grammar*. pp. 281-337. Dordrecht: Kluwer Academic Publishers.
- Södermanlands Runinskrifter*. 1924. Erik Brate and Elias Wessén (eds). Stockholm: Almqvist & Wiksell.
- Taraldsen, Knut Tarald. 1990. "D-projections and N-projections in Norwegian". In Joan Mascaró & Marina Nespó (eds.) *Grammar in Progress. Glow Essays for Henk van Riemsdijk*, pp. 419-431. Dordrecht: Foris Publications.
- Upplands Runinskrifter*. 1946. Elias Wessén and Sven B.F. Janson (eds). Stockholm: Almqvist & Wiksell.
- Vangnes, Øystein Alexander. 1999. *The identification of functional architecture*. Doctoral Dissertation, University of Bergen.
- Vincent, Nigel. 1997. "The emergence of the D-system in Romance". In Ans van Kemenade & Nigel Vincent (eds.) *Parameters of morphosyntactic change*, pp. 149-169. Cambridge: Cambridge University Press.
- Wessén, Elias. 1970. *Schwedische Sprachgeschichte*. (vol. 3) Berlin: Walter de Gruyter & Co.
- Zoëga, Geir T. 1910. *A Concise Dictionary of Old Icelandic*. Oxford: At the Clarendon Press.

Non-Verbal Predicates and the Distribution of *Ser* and *Estar* in Spanish*

Isabelle Roy

University of Southern California

1. Introduction

The distribution of the two verbs ‘to be’ *ser* and *estar* in Spanish is usually explained by the contrast between inherent *vs.* transient properties, a distinction often formalized as the contrast between *individual-level* predicates and *stage-level* predicates (cf. Carlson 1977). The verb *ser* is assumed to take individual-level (*i-level*) predicates only, i.e. predicates denoting inherent properties (see discussion in Fernández Leborans 1999: 2366-2367, for instance):

- (1) Juan es inteligente/ de Madrid.
 Juan ser.3sg intelligent from Madrid
Juan is intelligent / from Madrid.

The verb *estar*, by opposition, is assumed to be constructed with stage-level (*s-level*) predicates only, i.e. predicates denoting transient properties, as in (2):

- (2) Juan está ausente / en Madrid
 Juan estar.3sg absent in Madrid
Juan is absent / in Madrid.

A restricted class of predicates that can accommodate both an *i-level* and a *s-level* reading can be constructed with both verbs as in (3) (see Luján 1980:22, for more examples):

- (3) a. Juan es feliz.
 Juan ser.3sg happy
Juan is (a) happy (person).
 b. Juan está feliz.
 Juan estar.3sg happy
Juan is happy (now).

This view, however, faces a certain number of issues, starting with well-known counterexamples. An adjective like *muerto* “dead” denotes a property that is inherent even when constructed with *estar* (e.g. *Ana está muerta* “Ana is dead”); and predicates like *joven* “young”, which are necessarily transient, can be constructed with *ser* (e.g. *Pedro es joven* “Pedro is young”). If there is a distinction such as the i-level / s-level contrast operating at the predicate level and responsible for the distribution of the two copulas, it *cannot* be stated in terms of inherent vs. transient properties (see also Fernández Leborans 1999, Escandell-Vidal & Leonetti 2002, among others).

Second, as noted in the literature, it is possible to ‘coerce’ adjectives believed to be i-level only into an s-level reading, which means that, in the relevant contexts, any adjective can appear with *estar* (see also Escandell-Vidal & Leonetti 2002):

- (4) a. Esta solución está inteligente.
 this solution estar.3sg intelligent
 This solution is intelligent.
 b. La mesa está negra.
 the table estar.3sg black
 The table is dirty / black with dirt.
 c. La nieve está fría.
 the snow estar.3sg cold
 The snow is cold.

Likewise, the vast majority of adjectives believed to be s-level only can also, in actuality, have an i-level reading, and hence be constructed with *ser*:

- (5) a. Su mirada es ausente.
 his look ser.3sgabsent
 He has an absent face.
 b. Este amor es loco.
 this love ser.3sgcrazy
 This love is (a) crazy (love).
 c. Es cansado esto de ser Dios.
 ser.3sgtired this of to.be God
 It is (something) tiring being God.
 d. El deseo es rara vez satisfecho.
 the desire ser.3sg rare times satisfied
 Desire is rarely satisfied.

In the light of cases in (4)-(5), it appears that adjectives in Spanish behave in fact just like *libre* in (3), and can take both copulas. Accordingly, if the i-level/s-level contrast is responsible for the distribution of the two copular verbs, it does

not operate at the level of the lexicon. If it were a lexical distinction, we would have to assume, with very little explanatory power, that any adjective in Spanish is ambiguous between an i-level and a s-level predicate. Alternatively, we could assume that adjectives belong unambiguously to one of the two classes, and are allowed to appear with both verbs through ‘coercion’ mechanisms. But the fact that ‘coercion’ is so systematic, and goes in both directions (a fact frequently overlooked), seems to indicate instead that whatever contrast is responsible for the distribution of adjectives with *ser* and *estar* it is a syntactic contrast, rather than a lexical one.

Third, the distribution of nouns in copular sentences raises a further issue for the i-level/s-level view. In contrast to adjectives, nominals must be constructed with *ser* and can never appear with *estar* (6). Nouns do not necessarily denote inherent properties, however, as the fact that they appear with *ser* only would predict. Spanish (like other Romance languages as French, Portuguese and Italian) allows for the (apparent) optionality of the indefinite article with nominals in post-copular position (6a). When they occur without the indefinite article, nouns denote properties that are *not* inherent, as shown by the fact that they can receive temporal modifications (7), which is possible with s-level predicates only, and never with i-level ones (8) (see Roy, forthcoming, for further discussion):

- (6) a. Juan es (un) cantante. (NP)
 Juan ser.3sg(a) singer
 Juan is a singer.
 b. *Juan está (un) cantante.
 Juan estar.3sg (a) singer
- (7) Juan es cantante en sus horas libres.
 Juan ser.3sg singer in his hours free
 Juan is a singer on his spare time.
- (8) a. John is sick this morning (s-level)
 b. #John is tall this morning (i-level)

As nouns must be constructed with *ser* independently of whether they are transient or permanent, an account based on the i-level/s-level contrast (as a lexical distinction) would fail to make the correct predictions.

In sum, whatever the distinction determining the distribution of *ser* and *estar* is, (i) it is not a contrast based on the notion of permanency, (ii) it is not a lexical contrast, and (iii) it, apparently, affect nouns and adjectives differently.

2. Typology of Copular Sentences and Categorical Selection

One noticeable contrast between nouns and adjectives is that the former, contrary to the latter, are *never* subject to ‘coercion’: nouns must be constructed with *ser*, and cannot appear with *estar*, (compare (6) above with (4-5)). In order to appear with *estar* nouns must either be introduced by the preposition *de* ‘of’ (9), or by a degree adverbial (10):¹

- (9) Juan está [**(de)* cantante] _{PP}.
 Juan estar.3sg of singer
Juan is a singer.
- (10) Laura está [**(muy)* mujer] _{DegP}.
 Laura estar.3sg very woman
Laura is very feminine.

Based on this observation and on the conclusions drawn in the previous section, I propose that the distribution and interpretation of predicates in constructions with *ser* vs. *estar* is linked to their syntactic environment. I assume a typology of copular sentences that distinguishes fundamentally between *characterizing sentences* and *situation-descriptive sentences* (as argued for in Roy, forthcoming). The former are predications of *characterizing* properties of an individual (see, also Fernández Leborans 1999 for similar intuitions); while the latter are eventive and as such aspectual (see, for instance, Schmitt 1992).²

I propose that in Spanish, the copular verb differs in each type of sentences, *ser* appearing in *characterizing* sentences and *estar* in *situation-descriptive* sentences. Thus, post-copular expressions constructed with *ser* are interpreted as *characterizing* predicates; and those with *estar* as *situation-descriptive*.³ I further propose that in Spanish, all and only nouns are *characterizing* predicates; whereas all adjectives (and PPs) are *situation-descriptive*.

It follows from these assumptions that the verb *estar* can take every kind of predicates, i.e. APs, PPs, etc. except nouns, which is supported by the data presented in sections 1 and 2. It also follows that the verb *ser* must take a nominal expression in its post-copular position, which seems, *prima facie*, to be refuted by cases such as (1) and (5).

In the rest of the paper, however, I will develop the arguments supporting the strict categorical selection properties of the two copular verbs, and show that this view provides a unified account for the distribution of nouns and adjectives in copular sentences that finds further support cross-linguistically.

3. Adjectivals in Construction with *Ser*

The proposal in section 2 makes the prediction that all (apparent) adjectives must be nominals when constructed with *ser* and that ‘real’ predicative

adjectives can only occur with *estar*. I will argue for this view in this section, and to do so two cases need to be distinguished, the so-called ‘nominalized’ adjectives (cf. Fernandez Leborans 1999) and regular adjectives, which I will discuss in turn.

3.1 Noms(A)

‘Nominalized’ adjectives are adjectives that can be used either as an adjective (e.g. *reunión comunista_A* ‘communist meeting’, *coche francés_A* ‘French car’, etc.) or as a noun to refer (non-anaphorically) to individuals (e.g. *el comunista_N* ‘the communist’, *un francés_N* ‘a French’, *tres viejos_N* ‘three old men’, etc.).⁴ I will refer to them, when used as nominals, as Noms(A) (in order to stay away from any categorial derivation considerations).

In post-copular position of *ser* these forms, similarly to predicates that are unambiguously nouns (e.g. in (12)), allow optionally for the insertion of the indefinite article:⁵

- (11) Luis es (un) francés | (un) ciego | (un) analfabeto | etc.
Luis SER.3S (a) French (a) blind (an) illiterate ...
Luis is a French man / a blind man / an illiterate man
- (12) Luis es (un) médico | (un) periodista | (un) diplomata. | etc.
Luis SER.3S (a) doctor (a) journalist (a) diplomat ...
Luis is a doctor / a journalist / a diplomat

In the presence of the article, at least, the forms in (11) must be nouns, as regular adjectives can never appear with the indefinite article masculine singular *un*, and require instead the strong anaphoric form *uno* (as further discussed in section 3.2).⁶ This asymmetry is exemplified in (13) with the form *español*, which is homophonous between a Nom(A) and an A, but must be a Nom(A) when introduced by *un* (13a), and an A when introduced by *uno* (13b):

- (13) a. Luis es un poeta_N francés_A, y Pablo es un español_{*A/Nom(A)}.
Luis SER.3S a poet French and Pablo SER.3S a Spanish
*Luis is a French poet, and Pablo is a Spaniard / *a Spanish one/poet.*
- b. Luis es un poeta_N francés_A, y Pablo es uno español_{A/*Nom(A)}.
Luis SER.3S a poet French and Pablo SER.3S one Spanish
*Luis is a French poet, and Pablo is *a Spaniard / a Spanish one/poet.*

The semantic effect of article insertion is identical in (11) and (12), showing that the two forms are in actuality very similar.⁷ The paradigms in (14-15) show that in the case of ‘regular’ nouns (a) as well as Noms(A) (b), the indefinite

article insertion triggers obligatorily an *identificational* reading (in the sense of Higgins 1979) for the predicate: the variant with the article being thus a felicitous answer to the question *Who is X?* only, and not *What is X?* In contrast, the variant without the article are *predicational*, i.e. is felicitous as an answer to the question *What is X?* only. The paradigms set a clear parallelism between the cases of Ns in (a) and Noms(A) in (b) suggesting that the forms in (15b) may be bare Noms(A) here rather than As:

- (14) ¿Quién es Juan? a. Juan es *(un) médico/ periodista/ diplomata
Who is Juan? Juan ser3sg a doctor/ journalist/ diplomat
Juan is a doctor/ a journalist / a diplomat.
 b. Juan es *(un) ciego_N / francés_N / crítico_N.
 Juan ser3sg a blind / French / critic
Juan is a blind man / a French / a critic.
- (15) ¿Qué es Juan? a. Juan es (*un) médico/ periodista/ diplomata
What is Juan? Juan ser3sg a doctor / journalist / diplomat
Juan is a doctor / a journalist / a diplomat.
 b. Juan es (*un) ciego / francés / crítico.
 Juan ser3sg a blind / French / critic
Juan is blind / French / a critic.

Evidence that this is indeed the case comes from restrictions on adjective stacking. In post-copular position of *ser*, the forms homophonous between an A and a Nom(A) (i.e. as in (15b)) can co-occur (16):

- (16) No soy crítico profesional.
 NEG ser.2PLcritic professional
I am not a professional critic.

In Spanish, however, an adjective cannot modify another adjective (i.e. adjectives cannot be ‘stacked’) in the absence of an overt noun. Hence, a nominal phrase such as (17), constructed with two forms homophonous between an A and a Nom(A) (*sabio* ‘wise / wise man’ and *francés* ‘French / French man’) can only be interpreted either as a sequence Adj+N, as in (a), or as a sequence N+Adj as in (b), but never as a cluster of two adjectives *Adj+Adj, as in (c). (Example from Bosque 1999):

- (17) aquel sabio_{A/N} francés_{A/N}
 this wise/wise man French/French man
 a. ✓ *this wise French man*
 b. ✓ *this French wise man*
 c. * *this wise French one; *this French wise one*

The post-copular expression in (16) (where there is no article)⁸ must be, by the same rationale, a Nom(A) modified by an adjective and cannot be a concatenation of adjectives (and note that when the article is inserted it must be the indefinite article *un* and not *uno* in the case of the masculine singular: *No soy un/*uno crítico profesional* ‘I am not a professional critic/*critical one’).

In sum, the forms that are ambiguous between a Nom(A) and an A must appear as nominals when they are constructed with *ser*, with or without the indefinite article.⁹ Structurally, I will assume that the Noms(A) in (11) and the nouns in (12) are both Number Phrases (NumP), whose head can either be realized by the indefinite article, which I analyze as a number marking as in (18a) or can be left empty in the absence of the indefinite article, as in (18b):

- (18) a. [_{NumP} [_{Num0} *un*] [_{NP} N/Nom(A)]]
 b. [_{NumP} [_{Num0} Ø] [_{NP} N/Nom(A)]]

3.2 ‘Regular’ Adjectives

3.2.1 A dual puzzle

Not all apparent adjectives in post-copular position of *ser* are nouns, however, and I will argue here that regular adjectives are cases of null or elided N, with a structure as in (19), i.e. that when appearing to the right of *ser* they are used attributively to modify a null head N, rather than predicatively:

- (19) Luis es [_N importante]_{NumP}.
 Luis SER.3S important
Luis is (an) important (person).

Assuming that these adjectives are constructed in a NumP with a null or elided N, cases like (19) should a priori not be different from other cases of nominal predicates with *ser*, i.e. ‘regular’ nouns (e.g. *(un) médico* ‘a doctor’) and Noms(A) (e.g. *(un) salvaje* ‘a savage’; discussed in section 3.1). Two (related) puzzles arise here, however; and by answering them I attempt to show that the structure in (19) is in fact the relevant one for adjectives in post-copular position of *ser*.

The first puzzle is that in the case of (19) the insertion of the indefinite article *un* is ungrammatical (for masculine singular) (20), and the proform *uno* is required instead (21): why is *un* barred in (20) and possible in (11-12)?

- (20) *Luis es [_N importante].
 Luis SER.3SG an important

- (21) Luis es [uno \emptyset_N importante].
 Luis SER.3SG one important
Luis is an important one.

The second puzzle is that adjectives in elided structures in (19) can appear without an article altogether, although they involve, by assumption, a modified N, which typically forces article insertion in predicative contexts (see endnote 8): an overt N allows for the ‘optionality’ of the article in construction with *ser* (12), unless it is modified by an adjective, in which case the presence of the article is obligatory (22). However, if the head N is, by assumption, a null nominal the article becomes ungrammatical (see (23) and also (20)): why is *un* ungrammatical in (23) while it is obligatory in (22)?

- (22) Luis es *(un) profesor importante
 Luis SER.3SG a professor important
Luis is an important professor.
- (23) Luis es (*un) \emptyset_N importante
 Luis SER.3SG a importante
Luis is an important one.

3.2.2 *Pro*

In attempting to provide an explanation for these two puzzles, I propose that the null head N in (19) is a null pronominal *pro*, as in (24):

- (24) Luis es [_{NumP} [_N *pro*] importante].
 Luis SER.3SG important
Luis is (an) important (person).

Pro is an empty pronominal head in need of being identified, i.e. its semantic content must be recovered.¹⁰ Traditionally identification is assumed to be achieved through agreement marking on governing heads; in post-copular position, where *pro* is base-generated in the N position, it can be identified either by the article, when the article is present, or by the subject, through the agreement marking on the copula, when the article is absent.

In the first case, *pro* is identified by the agreement features on the indefinite article. The article *un* fails to identify *pro* because it is, I assume, underspecified for gender and possibly also number, contrary to the forms *una*, *unos* and *unas* (e.g. *María es una importante* ‘Maria is an important one’)¹¹, resulting in the ungrammaticality of (20). The pronominal head, instead of *pro*, must be realized by the overt proform *uno* (21). *Uno* is base-generated in N, and being both a proform and a numeral, must move from its original position to Num⁰ in order to check its agreement features:¹²

- (25) Luis es [NumP [Num *uno*_k] [NP [N t_k] [AP importante]]]
 Luis SER.3SG one important
Luis is an important one.

Support for the movement of *uno* comes from the impossibility of its co-occurrence with the indefinite article, the reason being precisely because *uno* is forced to move to Num⁰, thus blocking the insertion of the article *un*, assumed elsewhere to be in Num⁰:

- (26) Juan es (*un) uno importante; (*un) uno feliz; (*un) uno estupendo
 Juan SER.3S a one important a one happy a one wonderful
Juan is an important/happy/wonderful one.

In the case of the variant without the indefinite article, the head *pro* is identified by its antecedent, i.e. the subject of *ser*, through agreement on the copula. In order to be thus identified, however, I propose that *pro* must occupy the highest head of its projection, and must, therefore, rise to Num⁰, as in (27). *Pro* occupying the head Num⁰, the insertion of the indefinite article is blocked in this configuration, thus leading to its ungrammaticality in example (23):

- (27) [NumP [Num *pro*_k] [NP [N t_k] [AP importante]]]

In sum, assuming that the head N in (24) is a *pro* allows us to reduce the issue of the distribution of *un* vs. *uno* (20-21) and the contrast between null N vs. overt N (22-23) to the conditions on the identification of *pro*.

3.3 Conclusion

The apparent (bare) As in construction with *ser* are either Noms(A) (i.e. nouns) or *pro*-Adj forms (i.e. are used attributively to modify a null *pro*). The categorial selection properties of *ser* can now be reduced to one category only, i.e. that of nominals (either regular nouns, Noms(A), or *pro*-Adj forms¹³). The different readings (apparent) As can receive in construction with *ser* vs. *estar* follows from a lexical category change: Ns are *characterizing*, whereas As are *situation-descriptive*. This view allows us to account for the different interpretations of (apparent) As without postulating ambiguous lexical items; or without resorting to coercion mechanisms. In the analysis developed here all predicative adjectives are *situation-descriptive*. They become *characterizing* when constructed in a nominal expression only; and in principle, thus, any adjective can receive either reading (assuming that they can be used predicatively).

4. Cross-Linguistic Support for the N/A Dichotomy

What may seem at first a radical position for Spanish is indeed not an uncommon situation across languages. That the language is sensitive to a dichotomy between nominals as direct predicates in the one hand (found in characterizing sentences; with *ser*) and the rest on the other (found in situation-descriptive sentences; with *estar*) is not language specific characteristic of Spanish but is found in other (unrelated) languages as well. Let us consider two cases here.

4.1 Russian

Most Russian adjectives have both a long form (attributive and predicative) and a short form (predicative only), morphologically related. (Examples are from Matushansky 2002):

- (28) a. Teorija byla xoroša / xorošaja
 theory was good.A.SF / good.A.LF
The theory was good
 b. *xoroša / xorošaja teorija
 good.A.SF / good.A.LF theory
the/a good theory

In predicative position, the long forms, traditionally described as denoting “characteristics which are inherent in or completely identified with the noun” (Wade 1992:164) qualify as our *characterizing* predicates; whereas the short form which relate to “temporary states [...] or to specific contexts or circumstances” (p173) qualify as *situation-descriptive* ones. It seems, thus, that contrary to Spanish, Russian does have adjectives as *characterizing* predicates.

Long form adjectives, however, as commonly accepted, are elided nominal structures involving a null nominal head (see Babby 1975 and Siegel 1976 for arguments):

- (29) Studentka [umnaja \emptyset_N]
 student intelligent.A-LF
The student is (an) intelligent (student).

Russian is, thus, exactly like Spanish in allowing predicative adjectives in *situation-descriptive* sentences only; whereas apparent As in *characterizing* sentences are nominal predicates.

4.2 Modern Irish

Modern Irish (and see Adger and Ramchand 2003 for Scottish Gaelic), like Spanish, has two verbs “be” *is* and *bí*, that are generally said to predicate inherent properties vs. transient properties, respectively (Stenson 1981, Carnie

1995, Doherty 1996, for instance), and are in this sense very similar to *ser* and *estar*. Interestingly, the categorical selection properties of each verb pattern with their Spanish counterparts: the copula *is* takes all and only nouns (30)¹⁴, while the auxiliary *bí* takes everything else, except nouns (31):

- (30) a. Is dochtúir sé. (NP)
 is.pres doctor him
 He is a doctor.
- b. *Is cliste iad. (*predicative A)
 is.pres clever them
- c. Is duine cliste é. (attributive A)
 is.pres person clever him
 He is a clever person.
- (31) a. *Tá sé dochtúir. (*NP)
 bí.pres him doctor
- b. Tá sé mór. (AP)
 bí.pres him big
 He is big.
- c. Tá Seán i mBaile Atha Cliath. (PP)
 bí.pres Sean in Dublin
 Sean is in Dublin.

In order to be constructed with the verb *bí*, Ns must be embedded in a PP, setting a very clear parallelism with Ns in construction with *estar* in Spanish (see 9):

- (32) Tá sé ina dochtúir.
 bí.pres him in-his doctor
 He is a doctor.

Note that Modern Irish disallows an option that was found in Spanish and Russian, namely attributive adjectives modifying a null head noun in *characterizing* sentences (see (30b)). The ungrammaticality of (30b) correlates interestingly, however, with the absence of nominal ellipsis in argumental positions in Modern Irish.

Where Spanish and Russian allow adjectives to appear as nominals, with an elided N (33)-(34) (the long form adjectives only in Russian; examples from Matushansly 2004), Modern Irish requires, instead, N to be realized by an overt *dummy* noun (e.g. *ceann* for animate and *te* for inanimate) (35):

- (33) Quiero comprar la roja / la barrata / la inglesa (Spanish)
 want.1sg buy the red / the cheap / the English
I want to buy the red / cheap / English one
- (34) Daj mne krasnuju / elektricheskiju / francuzkiju (Russian)
 give me red.A-LF / electric.A-LF / French.A-LF
Give me the red/ electric/ French one
- (35) Tà me ag iarraidh an *(cheann) dearg (M.Irish)
 bí.pres me at seeking the thing red
I am looking for the red one

The contrast between (5) in Spanish and (30b) in Modern Irish is thus superficial only and relates to the possibility for a given language to have As as nominals in the absence of an overt nominal head.

5. Conclusion

I have argued in this paper that the distribution and interpretation of non-verbal predicates with the two copular verbs *ser* and *estar* in Spanish can be derived from the syntactic and semantic properties of copular sentences and copular verbs. In particular I have shown that *ser* can take nominals only, and that by analyzing 'regular' adjectives in construction with *ser* as nominals headed by a *pro* we can not only explain various properties of post-copular adjectives that would have been otherwise unrelated, e.g. the behavior of articles, the differences between overt and covert N, but furthermore we can unify in an interesting way the distribution of non-verbal predicates with *ser*.

The different interpretations of (apparent) adjectives in construction with *ser* vs. *estar* are associated here to a categorical difference, which allows us to account for the possible readings of adjectives without postulating ambiguous lexical items or coercion mechanisms. The source of the categorical split between nominals and non-nominal expressions, attested in other unrelated languages as well, has not been addressed in this paper, and I leave this issue open for further research.

Notes

* This paper benefited greatly from my discussions with Hagit Borer and Roumyana Pancheva. I am very thankful for their comments and suggestions. Thanks also go to the Hispanic Linguistics Student Association at USC for letting me present this paper at their meeting and Asier Alcázar and Mario Saltarelli for their helpful remarks; as well as the audience of WECOL'04 and Going Romance 2004 for comments. I would like also to thank my informants Mónica Cabrera, Rebeka

Campos, Roberto Mayoral Hernández and Ana Sanchez Nuñez. None of them are responsible for the use I made of their information.

¹ Note in this context that the only DPs that are compatible with *estar* are those that indicate a position on a scale: *el último* ‘the last one’, *el primero* ‘the first one’, etc. (Camacho 1993).

² This distinction is reminiscent to some extent of the contrast between categorical judgments vs.thetic judgments proposed by Kuroda (1992); and to the i-level/s-level distinction as a distinction at the level of the sentence proposed by Ramchand (1996).

³ The distinction between *characterizing* and *situation-descriptive* predicates is *not* related to the inherent/transient distinction. Characterizing predicates (i.e. in construction with *ser*) may tend to be interpreted as inherent properties, but this is only a tendency and not a necessity (cf. for instance, *Maria ya no es joven* ‘Maria no longer is(SER) a young person’, and bare nominals). Similarly, *situation-descriptive* predicates (i.e. in construction with *estar*) are not necessarily transient either (cf. for instance, *La nieve está fría* ‘The snow is(ESTAR) cold’).

⁴ Adjectives homophonous with nouns include adjectives denoting affiliations to nationalities and social groups (religions, political parties, social classes, occupations, etc.): *francés* ‘French’, *católico* ‘catholic’, *comunista* ‘communist’, *salvaje* ‘savage’, *militar* ‘military / soldier’, *científico* ‘scientific / scientist’, etc.; and certain adjectives denoting physical and psychological qualities: *ciego* ‘blind(man)’, *viejo* ‘old/elderly’, *joven* ‘young/youth’, *enfermo* ‘sick/patient’, etc.

⁵ The insertion of the indefinite article is generally believed to be restricted to deprecatory predicates only, and judgments such as those in (i) are reported in the literature (see, for instance Bosque 1999:64-65):

(i) Juan es {un bárbaro / #un civilizado ; un ilegal / # un legal ; etc.}

Juan SER.3S a barbaric / a civilized an illegal / a legal

Juan is a barbarian / # a civilized (person); an illegal (man) / # a legal (man).

In contexts that favor the ‘defining’ reading (associated to the presence of the indefinite article, see Roy forthcoming for discussion), the insertion of the indefinite article is, however, completely grammatical, and the apparent contrast in (i) disappears:

(ii) a. Una persona que estudia profundamente ‘leyes’ para poder cometer la más hábil

estafa y quedar a salvo: ¿ es un civilizado o es un bárbaro?

A person who studies profoundly ‘laws’ in order to commit the most clever crime, and get away with it: is he a civilized (person) or a barbarian?

b. Según Kierkegaard “todo hombre que vive estéticamente es un angustiado”. ...

According to Kierkegaard “every person who lives esthetically is an anguished (person).

⁶ This contrast occurs with the masculine singular indefinite article, and not with the feminine or plural forms, as I will discuss later.

⁷ I am ignoring here the semantic contribution of the presence vs. absence of the indefinite article in Spanish. For a detailed discussion see Roy forthcoming.

⁸ Adjectival modification of a nominal predicative head forces, in Romance languages, almost obligatorily the insertion of the indefinite article. In contrast to *Juan es (un) cantante* ‘Juan is a singer’, the article cannot be omitted when the head N ‘singer’ is modified by an adjective as in *Juan es *(un) cantante pacifista* ‘Juan is a pacifist singer’. There are, nevertheless, a few adjectives that can modify a predicate N without forcing the insertion of the article, among which *profesional* ‘professional’, for instance, as *Juan es (un) cantante profesional* ‘Juan is a professional singer’. (Note incidentally that *profesional* is also a Nom(A) in Spanish).

⁹ Note incidentally that when the categorical status of the predicate (as an A or an N) is associated with a notable change in meaning, it is the meaning of the N that these forms receive when they appear with *ser*, and the A when constructed with *estar*. A very clear example is the case of *militar* which, when predicated of humans, can be translated either as ‘military’ (as an A) or as ‘soldier’ (as an N). In construction with *ser*, it can only be interpreted as ‘soldier/serviceman’ however (e.g. *Mi vecino es militar* ‘my neighbor is a soldier’ / *?’my neighbor is military’) and accordingly can only

get the meaning of the N and not of the A. When predicated of non-humans, however, the change in meaning associated with the N is lost, and the form *militar* can thus be interpreted as 'military' (e.g. *Estas restricciones son militares* 'These restrictions are military (ones)'). This variation is consistent with the fact that *militar* is a Nom(A) when it occurs with *ser*.

¹⁰ *Pro* needs to be licensed as well. Spanish licenses null *pro* in argument position, subject and object, and I will assume here that it licenses *pro* with a predicative use as well.

¹¹ The article *una* is identical to the numeral and bears explicit gender marking; the plural article *unos/unas* bear overt number morphology.

¹² As a result of the movement, *uno* can never occur to the right of a modifying adjective. Thus, an adjective like *importante* can appear both pre-nominally and post-nominally when modifying an overt noun (*Es un importante problema / un problema importante* 'It is an important issue') (with differences in meaning that I will disregard here), but is pre-nominal only in the context of *uno* (*Es uno importante / *importante uno* 'It is an important one').

¹³ The *pro* analysis argued for here for adjectives extends straightforwardly to PPs as well (which cannot take *un* either and require *uno*, and must have a presuppositional reading); and the underlying structure of *Juan es de Madrid* 'Juan is from Madrid', can be assumed, accordingly, to be as in (i):

(i) [_{NumP} [_{Num} *pro*_k] [_{NP} [_N *t_k*] [_{PP} *de Madrid*]]]

¹⁴ The only cases of adjectives with *is* are non-productive and limited and are often a survival of an older system (see Stenson 1981 and Doherty 1996, *inter alia*). The copula *is* is fully productive with comparative and superlative adjectives, however, which have been argued to be nominals (Stenson 1976).

References

- Adger, David and Gillian Ramchand 2003. 'Predication and Equation', *Linguistics Inquiry*, 34.3:325-360
- Babby, Leonard. 1975. *A Transformational Grammar of Russian Adjectives*. The Hague: Mouton.
- Borer, Hagit and Isabelle Roy (forthcoming). 'The Name of the Adjective', *Recherches Linguistiques de Vincennes* vol. 34. Cabredo Hofherr P. and O. Matushansky (eds.), Saint Denis.
- Camacho, José. 1993. 'Aspectual Licensing of Predication in Spanish', Unpublished manuscript, University of California.
- Carlson, Gregory. 1977. *Reference to Kind in English*. New York: Garland Publishers.
- Carnie, Andrew. 1995. *Non-Verbal Predication and Head Movement*. Ph.D. dissertation, MIT, Cambridge.
- Doherty, Cathal. 1996. 'Clausal Structure and Modern Irish Copula', *Natural Language and Linguistics Theory*, 14:1-46
- Escandell-Vidal, V. & M. Leonetti 2002. 'Coercion and the Stage/Individual Distinction', *Semantics and Pragmatics of Spanish*. J. Gutiérrez-Rexach (ed.). Amsterdam: Elsevier.
- Fernández Leborans, M.J. 1999. 'La predicación: la oraciones copulativas', *Gramática descriptiva de la lengua española*. I. Bosque & V. Demonte (eds.). Madrid: Real Academia Española.
- Higgins, F. R. 1979. *The Pseudo-cleft Construction in English*. New York: Garland Publishers.
- Kuroda, S. Y. 1992. *Japanese Syntax and Semantics*. Dordrecht: Kluwer Academic Publishers.
- Matushansky, O. 2004. 'Best of'. Talk presented at USC.

- Matushansky, O. 2002. 'Encasing the Time: Temporal Effects on Russian Predicative Case'. Talk presented at NELS 23, MIT.
- Roy, Isabelle. (forthcoming). *Non-Verbal Predications*, PhD dissertation, University of Southern California.
- Schmitt, Cristina. 1992. 'Ser and Estar: a Matter of Aspect', *Proceedings for NELS 22*, GLSA.
- Siegel, Muffy. 1976. *Capturing the Adjective*. New York: Garland Publishing.
- Stenson, Nancy. 1976. 'Overlapping systems in the Irish comparative construction', *Word (Celtic Linguistics)* 28:78-95
- Stenson, Nancy. 1981. *Studies in Irish Syntax*. Ars Linguistica 8. Tübingen: Gunter Narr Verlag.
- Wade, T. 1992. *A Comprehensive Russian Grammar*. Cambridge: Blackwell Publishers.

Isabelle Roy
iroy@usc.edu

Dominance, Markedness Reversal and the Role of Local Conjunction: a Case Study of Kinande

Tomomasa Sasa

University of Southern California

1. Introduction

Kinande, a Bantu language of Zaire, exhibits a complex [ATR] harmony system. One of the main characteristics of Kinande [ATR] harmony is [+ATR] dominance, and in this language, only [+ATR] harmony is observed. Data illustrating [+ATR] harmony are given in (1).

(1) [+ATR] Harmony (Hyman 2002: 18-19)

- a) /-hɛk-/ ‘carry’ /ɔ-mu-hɛk-i/ → [o-mu-hɛk-i] ‘carrier’
 b) /-bɔh-/ ‘tie’ /ɔ-mu-bɔh-i/ → [o-mu-bɔh-i] ‘tier’

In (1a) and (1b), the mid vowels in the stem, which are underlyingly [-ATR], become [+ATR] because of the regressive harmony triggered by the word-final [+ATR] vowel, [i].

However, if no [+ATR] harmony is observed, as in (2), mid vowels in this language always surface as [-ATR].

(2) No Harmony: Mid Vowels Surface as [-ATR] (Hyman 2002: 19)

- a) /-hɛk-/ ‘carry’ /hɛk-ɪr-a/ → [hɛk-ɪr-a] ‘carry for/at’
 b) /-bɔh-/ ‘tie’ /bɔh-ɪr-a/ → [bɔh-ɪr-a] ‘tie for/at’

In (2a) and (2b), since there are no [+ATR] vowels, no [+ATR] harmony is observed. Thus, the mid vowels in the stem, which are underlyingly [-ATR], surface as [-ATR]. In fact, as Archangeli and Pulleyblank (2002) point out, [+ATR] mid vowels are restricted in occurrence in this language: they appear only when [+ATR] harmony is observed.

The purpose of this paper is to present an analysis of Kinande [+ATR] harmony (as in (1)) and non-harmony (as in (2)), concentrating on the role of local conjunction (Smolensky 1993, Bakovic 2000, Lubowicz 2002, Ito and Mester 2003, Beckman 2003). More specifically, I present an analysis with locally-conjoined faithfulness and markedness constraints (Bakovic 2000, Lubowicz 2002) and discuss the role of local conjunction in Kinande [+ATR] harmony and non-harmony.

In the previous phonological literature, several roles have been proposed for locally-conjoined markedness and faithfulness constraints. Bakovic (2000) proposes, for example, that locally-conjoined markedness and faithfulness constraints preserve the dominance value in dominant-recessive harmony systems. Lubowicz (2002) suggests that conjoined markedness and faithfulness constraints rule out marked segments, but only in derived environments. I propose that locally-conjoined markedness and faithfulness play both of these two roles in Kinande, and demonstrate that local conjunction both preserves the dominant value in harmony, and preserves underlying marked segments where no harmony is observed in this language.

2. Kinande Data

The Kinande vowel inventory is given in (2) (Archangeli and Pulleyblank 2002: 142).

(2) Kinande Vowel Inventory

	[+High]	[-High]
[-ATR]	ɪ ʊ	ɛ ɔ a
[+ATR]	i u	e o ə

According to Archangeli and Pulleyblank (2002), only high vowels exhibit a lexical contrast in their [ATR] specifications. Archangeli and Pulleyblank also note that the occurrence of the non-high [+ATR] vowels is restricted in this language: they appear only when regressive [+ATR] harmony takes place.

Kinande exhibits a complex [ATR] harmony system. First of all, as Hyman (2002) points out, both regressive (leftward) and progressive (rightward) harmony are observed in this language.¹ However, in this paper, I present data and analysis mainly for the regressive harmony of this language. Another main characteristic of Kinande [ATR] harmony is [+ATR] dominance; only [+ATR] vowels trigger harmony in this language. The data in (3) present examples of the regressive [+ATR] harmony observed in Kinande.

(3) Kinande Regressive Harmony (Hyman 2002: 18-19)

a) /-lɪm-/ ‘cultivate’	/ɔ-mʊ-lɪm-i/ →[o-mu-lim-i]	‘cultivator’
b) /-huk-/ ‘beat’	/ɔ-mʊ-huk-i/ →[o-mu-huk-i]	‘beater’
c) /-hek-/ ‘carry’	/ɔ-mʊ-hek-i/ →[o-mu-hek-i]	‘carrier’
d) /-bɔh-/ ‘tie’	/ɔ-mʊ-bɔh-i/ →[o-mu-boh-i]	‘tier’

In (3), the vowels in the stems become [+ATR] because of the agentive suffix at the end of the word. This agentive suffix, which contains a [+ATR] vowel underlyingly (Hyman 2002: 19), causes regressive [+ATR] harmony, and as a

environment as seen in (5c) and (5d). In (5c), for example, since no vowel triggers regressive [+ATR] harmony to the vowel in the stem, the mid vowel /ɔ/ in the stem surfaces as [-ATR]. Likewise, in (5d), the mid vowel in the stem /ɛ/ surfaces as [-ATR] since no [+ATR] vowel is following this mid vowel.

The figures in (6) and (7) illustrate the mappings of the high vowels and non-high vowels in non-harmony environments respectively.

(6) Mapping of high vowels in Kinande non-harmony:

- High vowels surface *faithfully*
- /i/ → [i]
- /ɪ/ → [ɪ]

As seen in (5a) and (5b), the underlying high vowels surface faithfully regardless of their [ATR] specifications; [-ATR] high vowels surface as [-ATR] and [+ATR] high vowels surface as [+ATR] in non-harmony environments.

Mid vowels, on the other hand, always surface as [-ATR] in non-harmony environments. This fact suggests that if there were [+ATR] mid vowels in the input, given the Richness of the Base Hypothesis of Optimality Theory, those [+ATR] mid vowels would be mapped onto [-ATR] mid vowels in non-harmony environments.

(7) Mapping of mid vowels in Kinande non-harmony (given Richness of the Base):

- Non-high vowels: *always* surface as [-ATR]
- /e/ → [ɛ]
- /ɛ/ → [ɛ]

To summarize, in Kinande, both high vowels and non-high vowels undergo the harmony process. When regressive [+ATR] harmony takes place, both high and non-high vowels surface as [+ATR]. In non-harmony environments, on the other hand, there is an asymmetry observed between high vowels and non-high vowels: high vowels surface faithfully when no harmony is observed. Thus, [-ATR] high vowels surface as [-ATR] in non-harmony environments as seen in (5a) and (5b). Mid vowels, on the other hand, always surface as [-ATR] in non-harmony environments. [+ATR] mid vowels are allowed only when [+ATR] harmony takes place as in (3c) and (3d), and no [+ATR] mid vowels are allowed in non-harmony environments in Kinande.

3. Analysis

In this section, I present an Optimality Theoretic (henceforth OT) analysis of Kinande [+ATR] harmony and non-harmony. In Section 3.1, I demonstrate that

the markedness hierarchy $*e/o \gg *I$ needs to be established to account for the asymmetry between high vowels and non-high vowels in non-harmony environments. In Section 3.2 and 3.3, I present an analysis with locally-conjoined faithfulness and markedness constraints to account for the regressive harmony in this language.

3.1 Non-harmony environments

As seen in Section 2, there is an asymmetry in occurrence between high vowels and non-high vowels in non-harmony environments: high vowels surface faithfully while non-high vowels always surface as [-ATR] when no harmony takes place.

In order to account for this asymmetry, I propose that the markedness constraint against non-high [+ATR] vowels must dominate the markedness constraint against high [-ATR] vowels. A faithfulness constraint for the [ATR] specifications also needs to be assumed so that high vowels in the input surface faithfully when no [+ATR] harmony is observed.

(8) $*[-HI, +ATR]$ ($*e/o$) (cf Archangeli and Pulleyblank 1994)
[-high, +ATR] vowels are prohibited.

(9) $*[+HI, -ATR]$ ($*I$) (cf Archangeli and Pulleyblank 1994)
[+high, -ATR] vowels are prohibited.

(10) **IDENT [ATR]** (**ID[ATR]**) (cf McCarthy and Prince 1995)

Segments in the output have the same specification for [ATR] as their input correspondents.

The tableaux in (11) and (12) illustrate that the ranking $*e/o \gg \text{ID[ATR]} \gg *I$ accounts for the asymmetry in occurrence in non-harmony environments.

(11) Markedness Hierarchy for Non-High Vowels (in NO harmony environment)

/boh-ir-a/ → [bɔh-ir-a]

/boh-ir-a/	$*[-HI, +ATR]$ ($*e/o$)	IDENT [ATR]	$*[+HI, -ATR]$ ($*I$)
a) bɔh-ir-a		*	*
b) boh-ir-a	*!		*

Given Richness of the Base of OT, in (11), I consider the input with a [+ATR] mid vowel, but nothing crucial depends on this assumption. The tableau in (11) shows that to prohibit /o/ in the input from surfacing in non-harmony environments, the ranking $*e/o \gg \text{ID[ATR]}$ is crucial.

For high vowels, on the other hand, the [ATR] specification of the input must be maintained in non-harmony environments. This is achieved by establishing the ranking, $\text{ID[ATR]} \gg *I$.

In (15a), the [+ATR] feature of V_2 is linked to the following vowel V_3 , but that [+ATR] feature is not linked to the preceding vowel. In (15b), although both V_1 and V_2 are [+ATR], they do not share the same [+ATR] feature associated with V_2 . In these two configurations, **SPREAD[+ATR]-L** is violated.

As pointed out in Section 2, [+ATR] is the dominant value in Kinande and only [+ATR] feature spreads in this language. Thus, in the spreading constraint, I specify the feature as [+ATR]. In Padgett's original formulation of **SPREAD**, directionality of spreading is not specified. However, in order to account for the directionality of [+ATR] spreading in Kinande, I incorporate the directionality in the spreading constraint itself.²

The tableau in (16) illustrates that the high-ranked **SPREAD [+ATR]-L**, dominating the markedness constraint against [e], enforces regressive harmony (with the input in (16), /ε-ri-bεε/, there is one more candidate to be evaluated, which is *[ε-ri-bεε] with all [-ATR] vowels. This candidate and the problems with this candidate are discussed in Section 3.3).

(16) **SPREAD [+ATR]-L** enforces regressive harmony

/ε-ri-bεε/ → [e-ri-bεε] (Input with all [-ATR] mid vowels)

/ε-ri-bεε/	SPREAD [+ATR]-L	*[-Hi, +ATR] (*e)	IDENT [ATR]	*[+Hi, -ATR] (*i)
a) e-ri-bεε		*	*	
b) ε-ri-bεε	*!			
c) e-ri-bere		**!*	***	

In (16), the [+ATR] high vowel in the prefix [-ri-] triggers regressive [+ATR] harmony. Both (16a) and (16c) satisfy **SPREAD [+ATR]-L** because the mid vowel in the word-initial prefix harmonizes with the following [+ATR] vowel. (16b), on the other hand, violates this harmony constraint, since the word-initial mid vowel does not harmonize with the following [+ATR] vowel. Thus, the ranking **SPREAD [+ATR]-L** >> *e needs to be established. Between the remaining candidates, (16a) and (16c), (16c) loses because of the markedness constraint against the non-high [+ATR] vowels.

There are two things to be noted in tableau (16), where a disharmonic form is selected as the actual output. First of all, the dominant value [+ATR] needs to be specified in the spreading constraint. If **SPREAD [ATR]-L** is assumed instead, candidate (16c), or another possible candidate, *[ε-ri-bεε], is selected over the actual form. Candidate (16c) also shows that it is necessary to specify directionality in the harmony constraint itself; if **SPREAD [+ATR]** without any specified directionality is assumed, (16c), where all the vowels are [+ATR], is wrongly selected as optimal. Recall that in Kinande, the vowels in the stem undergo the regressive harmony caused by the [+ATR] vowel in the suffix as seen in (3). Thus, stem/root faithfulness constraint cannot be high-ranked in this language.

The established ranking from Sections 3.1 and 3.2 is given in (17).

(17) Ranking Summary I

SPREAD[+ATR]-L >> *e/o >> IDENT[ATR] >> *i

In Kinande, mid [+ATR] vowels are more marked and restricted in occurrence than high [-ATR] vowels. This is captured by the ranking *e/o >> IDENT[ATR] >> *i. However, when [+ATR] harmony takes place, mid vowels become [+ATR]. The ranking SPREAD[+ATR]-L >> *e/o accounts for this change in harmony environments.

3.3 Preserving the dominant value: analysis with local conjunction

In the previous section, the high-ranked SPREAD [+ATR]-L, dominating the markedness constraints, enforces regressive [+ATR] harmony. However, specifying the dominant feature in the harmony constraint alone is not sufficient to guarantee the dominant value in the output. This problem is illustrated in (18). In (18), the bomb (☛) indicates the winning candidate that is wrongly predicted.

(18) Vacuous Satisfaction of SPREAD [+ATR]-L

/ε-ri-bεrε/ → [e-ri-bεrε] (Regressive Harmony within the Prefixes)

/ε-ri-bεrε/	SPREAD [+ATR]-L	*[-Hi, +ATR] (*e)	IDENT [ATR]	*[+Hi, -ATR] (*i)
a) e-ri-bεrε		*!	*	
☛b) ε-ri-bεrε			*	*

(18b), with all [-ATR] vowels, is wrongly predicted by the constraints and the ranking proposed thus far. In (18b), the dominant value [+ATR] is not present and as a result, SPREAD [+ATR]-L is vacuously satisfied. Since both (18a) and (18b) satisfy SPREAD [+ATR]-L, the markedness constraint *e determines the winner. The actual form (18a) loses because of this markedness constraint.

Given the markedness hierarchy of this language established in (11) and (12), the actual form, candidate (18a), is more marked than (18b): the actual form contains a mid [+ATR] vowel as a result of the [+ATR] harmony. In contrast, (18b) is less marked, but in this candidate, the dominant value of the harmony is lost. Therefore, the markedness hierarchy needs to be reversed to select a more marked candidate to fully account for the regressive harmony. Following Bakovic (2000) and Lubowicz (2002), I propose locally-conjoined markedness and faithfulness constraints as a solution to this problem.

The proposed local conjunction is given in (19). I conjoin the faithfulness constraint for the [ATR] specifications and the markedness constraint *i so that the markedness constraint is activated only when the faithfulness constraint is violated (i.e. only in the harmony environments).³

(19) {IDENT [ATR]&*[+HI, -ATR] (*I)}_{SEG} (cf Bakovic 2000, Lubowicz 2002)
 [+high, -ATR] vowels are prohibited when input and output correspondent segments do not have identical [ATR] specifications (no derived [+high, -ATR] vowels).

This local conjunction is violated when both markedness and faithfulness constraints are violated. The effect of this local conjunction is illustrated in (20).

(20) High-Ranked Local Conjunction

/ε-ri-bεε/ → [e-ri-bεε]

/ε-ri-bεε/	ID [ATR] &*I	SPREAD [+ATR]-L	*[-HI, +ATR] (*e)	IDENT [ATR]	*[+HI, -ATR] (*I)
a) e-ri-bεε			*	*	
b) ε-ri-bεε	*!			*	*
c) ε-ri-bεε		*!			

Bakovic (2000) suggests that locally-conjoined markedness and faithfulness constraints successfully preserve the dominant value in the output in a dominant-recessive harmony system. This effect is observed in (20). The actual form (20a) does not violate the high-ranked local conjunction: although this candidate violates the faithfulness constraint for the [ATR] specification (from /ε/ to [e]), this candidate does not contain a [+high, -ATR] vowel. (20b), on the other hand, is excluded by this local conjunction: this candidate contains a [+high, -ATR] vowel (markedness violation) because of the change from [+ATR] to [-ATR] (faithfulness violation). (20c) also satisfies this local conjunction, but this candidate is excluded by the spreading constraint.

Thus, as seen in (20), with locally conjoined faithfulness and markedness constraints, it becomes possible to select the actual form with a trigger of the harmony and the dominant value of the harmony. As a result, the more marked candidate is selected over the less marked candidate. However, assuming local conjunction is not the only way to preserve the dominant value (through preserving the trigger) in the output form. Archangeli and Pulleyblank (2002), for example, propose an analysis with **GROUNDING CONDITION** to account for Kinande [+ATR] harmony.

(21) **GROUNDING CONDITION** **Hi/ATR** (Archangeli and Pulleyblank 1994, 2002:145)

If [+high], then [+ATR].

GROUNDING CONDITION requires that high vowels surface as [+ATR] regardless of their input [ATR] specification. The analysis with **GROUNDING CONDITION** makes the same prediction for the occurrence of the high vowels in the harmony environments. It prohibits the change from underlying [+ATR] high vowels into [-ATR] in the harmony environments, and thus, successfully

preserves both the trigger of the harmony and the dominant value of the harmony.

However, the analysis with **GROUNDING CONDITION** will make a different prediction in non-harmony environments. As pointed out, if no [+ATR] harmony takes place, underlying [+high, -ATR] vowels surface faithfully (i.e. as [-ATR]) in Kinande. Since **GROUNDING CONDITION** requires that [+High] vowels surface as [+ATR] in any environment, the analysis with **GROUNDING CONDITION** will be potentially problematic in accounting for the occurrence of the high [-ATR] vowels in non-harmony environments in Kinande.⁴

The analysis with local conjunction, on the other hand, is capable of explaining the asymmetry of harmony environments and non-harmony environments. As Lubowicz (2002) points out, the function of locally conjoined faithfulness and markedness constraints is to activate the low-ranked markedness constraints only in limited environments (such as in derived environments). In Kinande, the low-ranked markedness constraint ***I** is activated only when harmony takes place (i.e. when the faithfulness constraint is violated). In other words, when no harmony is observed, the markedness constraint is not activated. This is illustrated in (22).

(22) Local Conjunction Preserves Underlying [+Hi, -ATR] Vowels

/lim-ir-a/ → [lim-ir-a] (NO Harmony)

/lim-ir-a/	ID[ATR] &*I	SPREAD [+ATR]-L	*[-Hi, +ATR] (*e/o)	IDENT [ATR]	*[+Hi, -ATR] (*I)
☞ a) lim-ir-a					**
b) lim-ir-a				*!*	

(22) examines the mapping of the high [-ATR] vowels in non-harmony environments. In the input, there are no [+ATR] vowels and thus, the underlying [+high, -ATR] vowels surface as [-ATR]. The actual form (22a), with all [-ATR] vowels, satisfies the high-ranked local conjunction, **{IDENT [ATR]&*[+Hi, -ATR]}**_{SEG}: although this candidate contains [+high, -ATR] vowel, it satisfies the faithfulness constraint. Candidate (22b) satisfies both local conjunction and the spreading constraint, but this candidate is excluded by **IDENT [ATR]**. Notice that the actual form (22a) violates **GROUNDING CONDITION**, since this form contains [+high, -ATR] vowels and the analysis with **GROUNDING CONDITION** will prefer (22b), with all [+ATR] high vowels, in non-harmony environments.

The final ranking lattice is given in (23).

(23) Ranking Lattice

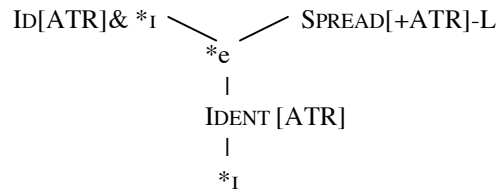

The tableau in (20) shows that it is necessary to establish the ranking **ID[ATR]& *ɪ** >> *e. This ranking is crucial for the markedness reversal, through which the trigger and dominant value are preserved in the output. The markedness constraint *e also needs to be dominated by **SPREAD[+ATR]-L**. Because of this established ranking, the mid vowels surface as [+ATR] when the harmony takes place in this language.

4. Conclusion

Several roles have been suggested in the previous phonological literature for locally-conjoined markedness and faithfulness constraints. Bakovic (2000) argues that local conjunction preserves and guarantees the dominant value in harmony, and Lubowicz (2002) suggests that locally-conjoined markedness and faithfulness constraints prohibit marked segments, but only in limited environments. This case study of Kinande shows that local conjunction plays both of these two roles in a single language. (20) shows that local conjunction preserves the trigger and the dominant value of the harmony, and (22) shows that local conjunction allows underlying marked segments to surface when no vowel triggers harmony.

One of the major roles that local conjunction plays is that it successfully preserves the trigger of the harmony, which is [+ATR] vowels, in the harmony environments. As seen in (18), specifying the dominant value in the harmony constraint alone is not sufficient to guarantee that the dominant value is preserved in the output form. In (20), the high-ranked local conjunction preserves the trigger of the harmony, and as a result, the dominant value is preserved in the output form. The interaction of local conjunction and the spreading constraint makes it possible for the more marked candidate to surface.

Maintaining the [+ATR] dominant value is crucial in accounting for the harmony cases. In non-harmony environments, on the other hand, it is more important that the underlying marked segments, in this case, [-ATR] high vowels, surface faithfully. Thus, in this language, there is an asymmetry in the occurrence of high vowels: [-ATR] high vowels are prohibited in harmony environments, while in non-harmony environments, the underlying [-ATR] high vowels surface faithfully. This asymmetry can be also accounted for by assuming local conjunction, and as seen in (22), the underlying [+high, -ATR]

vowel surfaces faithfully when no harmony takes place. As pointed out, the analysis with **GROUNDING CONDITION** will make a different prediction for the underlying [+high, -ATR] vowels in non-harmony environments.

Finally, as I pointed out in Section 2, not only regressive but also progressive harmony is observed in this language. To account for the regressive harmony of Kinande, I presented an analysis with **SPREAD [+ATR]-L** with specified directionality along with the local conjunction. However, as Hyman (2002) points out, there is progressive harmony observed in this language: progressive (rightward) harmony is also triggered by [+ATR] vowels in this language. Since progressive harmony is also [+ATR] dominant, the local conjunction proposed in this paper will also play a role in accounting for progressive harmony. However, the means of achieving rightward directionality while allowing leftward is an issue for future research in Kinande [+ATR] harmony.

Notes

¹ According to Hyman (2002), progressive harmony is more restricted than regressive harmony in Kinande. For example, progressive [+ATR] harmony from the stem to a suffix is commonly observed in this language. However, not all [+ATR] prefixes can trigger progressive harmony to a stem.

² For achieving feature spreading with specified directionality, there are several other ways. Assuming an **ALIGNMENT-L** constraint for a feature will also yield the same effect. Specifying the span and the head of the [+ATR] harmony assuming **Span Theory** (McCarthy 2004) is another possible way to define the directionality. However, a comparison of **SPREAD** and **ALIGN / Span Theory** is beyond the scope of this paper.

³ An alternative to local conjunction is to assume a unidirectional (I→O) faithfulness constraint (Pater 1999, Gressang 2002) for [ATR]. For example, Gressang (2002) assumes **IDENT I→O [+ATR]** to preserve the [+ATR] feature in the output in Maasai [ATR] harmony. In Kinande, **IDENT I→O [+ATR] [+Hi]**, with reference to the height, will preserve the [+high, +ATR] trigger in the output. The status of such unidirectional faithfulness constraints is beyond the scope of this paper.

⁴ The analysis with **GROUNDING CONDITION** predicts that /ε-ri-bere/ will surface as [e-ri-bere] with all [-ATR] mid vowels. In fact, Archangeli and Pulleyblank (2002) assume a different data set, and in their data set, [ε-ri-bere] is listed as an actual form. The Kinande data cited in this paper are taken from Hyman (2002: 19), where, as cited in (6) in Section 2, [e-ri-bere], with a [+ATR] mid vowel in the word-initial prefix, is listed as an actual form.

References

- Archangeli, Diana and Douglas Pulleyblank. 1994. *Grounded Phonology*. Cambridge MA: MIT Press.
- Archangeli, Diana and Douglas Pulleyblank. 2002. "Kinande vowel harmony: domains, grounded conditions and one-sided alignment," *Phonology*, 19. 2: 139-188
- Bakovic, Eric. 2000. *Harmony, Dominance and Control*. PhD Dissertation. New Brunswick NJ: Rutgers, The State University of New Jersey.
- Beckman, Jill. 2003. "The case for local conjunction: evidence from Fyem," *Proceedings of the 22nd West Coast Conference on Formal Linguistics*: 56-69

- Gressang, Jane. 2002. "Dominant and recessive [ATR] harmony in Maasai," paper presented at 8th Mid Continental Workshop in Phonology. Bloomington, IN
- Hyman, Larry, M. 2002. "Is there a right-to-left bias in vowel harmony?" Paper presented at the 9th International Phonology Meeting. Viena
- Ito, Junko and Armin, Mester. 2003. "On the sources of opacity in OT: coda processes in German," Rutgers Optimality Archive [<http://roa.rutgers.edu> (ROA# 347-0999)]
- Lubowicz, Anna. 2002. "Derived environment effects in Optimality Theory," *Lingua* **112**: 243-80 [<http://roa.rutgers.edu> (ROA # 103)]
- McCarthy, John and Alan Prince. 1995. "Faithfulness and reduplicative identity," *Papers in Optimality Theory*: 249-384
- McCarthy, John. 2004. "Head spans and Autosegmental spreading," Rutgers Optimality Archive [<http://roa.rutgers.edu> (ROA# 685-0904)]
- Padgett, Jaye. 1997. "Partial class behavior and nasal place assimilation," Rutgers Optimality Archive [<http://roa.rutgers.edu> (ROA# 113-0000)]
- Padgett, Jaye. 2002. "Feature Classes in Phonology," *Language*, **78**. 1: 81-110
- Pater, Joe. 1999. "Autosegmental nasal substitution and other *N_C effects," *The Prosody Morphology Interface*: 310-343
- Sasa, Tomomasa. 2004. "Directionality in Harmony: Evidence from Pulaar," MA Screening Paper. University of Southern California.
- Smolensky, Paul. 1993. "Harmony, markedness and phonological activity," Rutgers Optimality Archive [<http://roa.rutgers.edu> (ROA#87-0000)]
- Walker, Rachel. 2000. *Nasalization, Neutral Segments, and Opacity Effects*. New York, NY: Garland Publishing Inc.

On the Durational Variability of Svarabhakti Vowels in Spanish Complex Onsets

Benjamin Schmeiser

University of California, Davis and Illinois State University

1. Introduction

It has long been noted (Gili Gaya 1921, Lenz 1892, Malmberg 1965, Navarro Tomás 1918, Quilis 1988) that Spanish complex onsets containing /r/ in second position typically exhibit an intervening vowel-like element, or *svarabhakti vowel* (henceforth, SV), represented in this paper in phonetic transcription as [°]. In an early phonetic study, Gili Gaya (1921) measured the duration of SVs in Peninsular Spanish, based on speakers' pronunciations of isolated words with /Cr/ appearing in different positions. He found that the duration of the intervening SV is highly variable, even in the same word repeated several times by the same speaker. More recently, Bradley and Schmeiser (2003) provided a different interpretation based on a reanalysis of Gili Gaya's (1921) measurement data: SVs tend to be longer in word-initial and stressed /CrV/ demisyllables than in non-initial or unstressed ones, respectively. Longer SVs are also favored in /Cr/ clusters that exhibit a back-to-front order of constriction location (i.e., dorsal + /r/) than in /Cr/ clusters with the opposite order (i.e. labial + /r/). Based on these tendencies, Bradley and Schmeiser (2003) formulated three hypotheses based on prosodic and segmental factors and added two more based on articulatory factors. The goal of this study is to test these five hypotheses with empirical data in order to identify which factors affect SV duration.

Five speakers of Peninsular Spanish were recorded reading a short passage. All 159 /Cr/ tokens were extracted and analyzed spectrographically, yielding duration measurements for the SV. Single-factor ANOVAs reveal significant effects at $p < .05$ for two of the five variables, namely order of constriction location and voicing of C_1 . The present study also corroborates the results of Blecua (2001) for Peninsular Spanish, in which the voicing of C_1 is found to have a significant influence on the duration of the rhotic (although Blecua includes the duration of SVs in the calculation of rhotic duration itself).

This paper is organized as follows. In Section 2, I define and discuss the problem at hand, making reference to previous studies. Section 3 includes the methods utilized for the data collection. In section 4, I discuss my findings of the study and attempt to analyze the phenomena within an Articulatory Phonology framework. Moreover, I compare my results with those of recent studies, namely that of Blecua (2001). Section 5 concludes.

2. The Problem

Around the turn of the 20th Century, linguists (Lenz 1892, Navarro Tomás 1918, Gili Gaya 1921) began to look at a vowel-like element that can occur on either side of the Spanish tap, [r]. This vowel-like element, called a *svarabhakti* vowel (henceforth, SV), can occur in three environments in Spanish. Firstly, it may occur to the left of the tap, as in, *cuadras* [ð^ar] ‘stables’:

Figure 1 -- A waveform and spectrogram of the lexical entry, *cuadras* ‘stables’

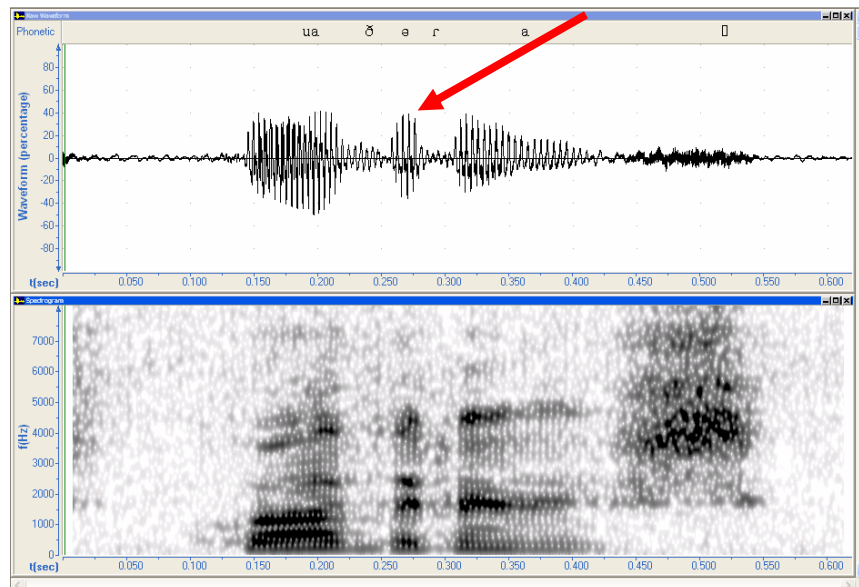

Figure 1 shows a waveform and a spectrogram of the lexical entry, *cuadras* ‘stables.’ The reader will take note of the SV located between the approximant [ð] and the canonical Spanish tap [r]. In this particular example, the SV is 22.6 ms in duration while the tap is 26.6 ms.

Secondly, it may occur either to the right of the tap, as in, *parte* [r^ot] ‘part,’ or in word-final before a pause, as in *hablar* [r^o]. The current study restricts itself to solely the left-hand SV environment. More specifically, the study treats SVs within a complex onset. That is, a consonant cluster in the onset position of the syllable. In Spanish, there are ten possibilities for the C₁ position and they are listed in the following table by manner of articulation.

Table 1 – Possibilities for C₁ in a Spanish Complex Onsets

MANNER OF ARTICULATION	C ₁ OF SPANISH COMPLEX ONSETS
voiceless fricative	[f]
voiceless stop	[p], [t], [k]
voiced stop	[b], [d], [g]
voiced approximants	[β], [ð], [ɣ]

Gili Gaya’s (1921) study was one of the first to take durational measurements of the SV, noting not only its variability in general, but even noting variability within the same word or the same speaker. Gili Gaya (1921) categorized the 176 tokens into the three aforementioned environments, namely the one left-hand environment and the two right-hand environments. Furthermore, Gili Gaya also noted that duration of the SV in many cases was actually longer than the tap itself. Typically, the Spanish tap lasts between 18 and 25 milliseconds (ms) (Quilis 1988), though Navarro Tomás (1918) notes the tap’s duration to be 25 to 30 ms. However, Gili Gaya found the SV to be shorter than the tap in only 6.3% of the cases. He found the duration of the SV to be equal to that of the tap in 14.2% of the cases and SV duration was actually longer than the tap in 80.1% of the cases.

He noted that the average duration of the SV was longest in the left-hand environment, for which he analyzed 73 tokens. Moreover, Gili Gaya found the left-hand SV environment had the highest percentage of SV presence. That is, of the sixty-one tokens for the left-hand SV environments, only three tokens (4.9%) were without the vowel-like element. It is here, then, where we arrive to the central question of this investigation: If this vowel-like element, which was found to be longer than the tap in the majority of the tokens analyzed, has a high level of variance, what are the factors that influence SV duration? What are the specific environments that condition SV duration *systematically*?

Bradley and Schmeiser (2003) categorized Gili Gaya’s (1921) data in the following table in an effort to identify prosodic and segmental influences:

Table 2 – Prosodic and segmental influences on the duration of SV in /Cr/ clusters (adapted from Bradley and Schmeiser, p. 2)

VARIABLE	MEAN DURATION OF SV (CS) BY CLUSTER TYPE			
	Position within the word	Word-initial	5.3	Word-internal
Stress	Stressed syllable	6.5	Unstressed syllable	5.2
Order of constriction location	Back-to-front	6.3	Front-to-back	5.5

Thus, though not significant statistically, the data in Table 2 seem to indicate that SV duration is longer in word-initial position than in word-internal, longer in a stressed syllable than unstressed and longer in a back-to-front order of constriction than in front-to-back. Based on these findings, Bradley and Schmeiser (2003) proposed three hypotheses. In addition, two more hypotheses were added regarding articulatory factors for a total of five hypotheses, listed below:

1. Word-initial /CrV/ demisyllables will evidence longer SVs than non-initial ones.
2. Stressed /CrV/ demisyllables will evidence longer SVs than unstressed ones.
3. /CrV/ demisyllables with a back-to-front order of constriction location (i.e., /kr/ and /gr/) will evidence longer SVs than ones with a front-to-back order (i.e., /fr/, /pr/, and /br/).
4. Heterorganic /Cr/ clusters (i.e., /fr/, /pt/, /br/, /kr/, and /gr/) will evidence longer SVs than homorganic ones (i.e., /tr/ and /dr/).
5. /Cr/ clusters in which C₁ is voiced will evidence longer SVs than ones in which C₁ is voiceless.

These five hypotheses were put forth with the hope of being tested with empirical data. By testing these hypotheses, we would gain valuable insight into the factors affecting SV duration for Spanish complex onsets. This, then, is precisely the goal of this study.

3. Data Collection

Five speakers of Peninsular Spanish were recorded reading a short passage. All /Cr/ tokens were extracted and analyzed spectrographically using Speech Analyzer 2.6, yielding duration measurements for the SV, the rhotic constriction, the previous vowel or consonant and the following vowel. There was a total of 159 tokens. For each speaker, there were 33 tokens¹, divided into the following categories:

Table 3 -- Breakdown of the tokens with SVs taken from the five speakers

VARIABLE	NUMBER OF TOKENS		TOTAL
Position within the word	Word-initial 85	Word-internal 30	115
Stress	Stressed syllable 59	Unstressed syllable 56	115
Order of constriction location	Back-to-front 35	Front-to-back 50	85
Place Agreement	Heterorganic /Cr/ 85	Homorganic /Cr/ 30	115
Voicing	Voiced C ₁ 40	Voiceless C ₁ 75	115

4. Data Analysis

4.1 Results

By conducting a Single Factor ANOVA, significant difference between means (with the p value less than .05), two of the five hypotheses showed statistically relevant results. Table 4 shows the average durations, along with their respective ANOVA results:

Table 4 -- Mean SV duration and ANOVA p values

VARIABLE	MEAN SV DURATION (MS)		PROBABILITY (ANOVA)
1. Position within the word	Word-initial 22.59	Word-internal 22.40	p=0.933428301
2. Stress	Stressed syllable 22.99	Unstressed syllable 22.06	p=0.641062263
3. Order of constriction location	Back-to-front 27.77	Front-to-back 20.76	p<0.005
4. Place Agreement	Heterorganic /Cr/ 23.65	Homorganic /Cr/ 19.41	p=0.061046886
5. Voicing	Voiced C₁ 27.33	Voiceless C₁ 20.07	p<0.001

Among the variables tested, Variables 1. Position within the word and 2. Stress showed the smallest difference between means. Variable 4. Place Agreement, however, showed a larger difference between means, though not quite enough to be considered statistically significant. 3. Order of constriction and 5. Voicing were the only two variables that showed statistically significant results, with 5. Voicing showing the largest difference between means.

4.2 Discussion of Results

4.2.1 Articulatory Phonology and Spanish Complex Onsets

It is at this juncture, then, that we must examine these results in theoretical terms. To best explain SV presence and duration, we turn to Articulatory Phonology (henceforth, AP) (Browman and Goldstein, 1986, 1988, 1989, 1990, 1992) as our framework. In AP, a 'gesture' is defined as a 'spatio-temporal unit, consisting of the attainment of some constriction at some location in the vocal tract' (Gafos, 2002:270, 271). In Gafos' terms, gestures are characterized by 'landmarks.' The following figure shows a gesture with its internal duration (marked abstractly in a 360° cycle), along with its corresponding landmarks.

Figure 2 -- A Gesture with Landmarks (as adapted from Gafos, 2002: 276)

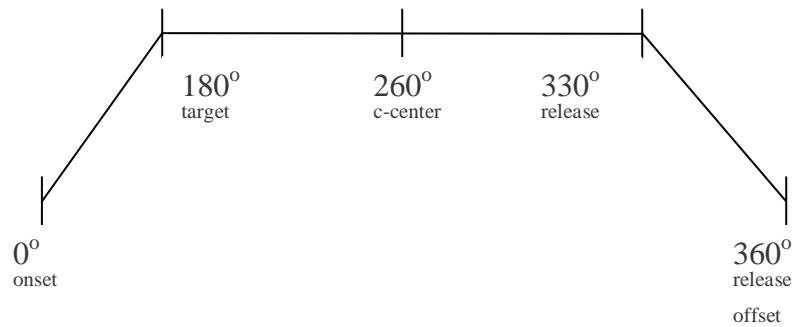

There are three relevant aspects of AP for this discussion:

- 1) articulatory gestures have internal duration, a property represented abstractly in terms of a 360° cycle. Phonetic timing is thus intrinsic to the phonological representation
- 2) adjacent gestures are temporally coordinated with respect to each other and may exhibit varying degrees of overlap
- 3) Finally, consonantal articulations are *superimposed on vocalic gestures*, which are themselves articulatorily adjacent (Gafos 1999).

By discussing /Cr/ onset clusters in Spanish in terms of adjacent gestures that are temporally coordinated, we are able to then concisely discuss SV variation.

For Byrd, coordination between associated gestures is assumed to be variable but constrained to particular ranges specific to the types of gestures involved (e.g. C-to-C) (1996a: 148). These ‘ranges’ are specified by the lexical representation and are called Phase Windows. A Phase Window, then, is quite useful because it acts to limit the temporal compressibility or disassociation of gestures. Moreover, it is also useful for capturing the timing variability observed in the coordination of gestures.

Pertaining to complex onsets, Byrd (1996b) presents some evidence that an onset cluster is less overlapped and less variable than a like coda cluster and heterosyllabic sequence. With direct regard to this analysis of Spanish /Cr/ clusters, Figure 3 illustrates how we view a canonical SV within an AP framework:

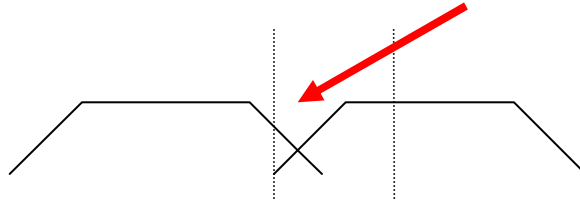
Figure 3 – A Canonical SV: *tres* → [t³res] ‘three’

The Phase Window (represented by two vertical dotted lines) begins at the onset (see Figure 2 for review of landmark terms) of the second gesture (i.e. the tap, [r]), thus movement of the C_1 gesture² will control the perception of the SV. The declining line of the first gesture, called the release, extends into the Phase Window and intersects with the following gesture. This area of intersection, marked in Figure 3 by an arrow, shortens both C_1 's release *and* C_2 's onset, thus allowing for the underlying vowel to be briefly perceived by the listener. Here the reader is reminded of the third relevant aspect of AP mentioned above, namely, that consonantal articulations are superimposed on vocalic gestures.

Lastly, take note that if the two gestures do not intersect in the Phase Window (that is, the release offset of the first gesture borders the onset of the second gesture), the result is, diachronically, that the SV is perceived as a full vowel and achieves full vowel status phonologically, as shown in Figure 4:

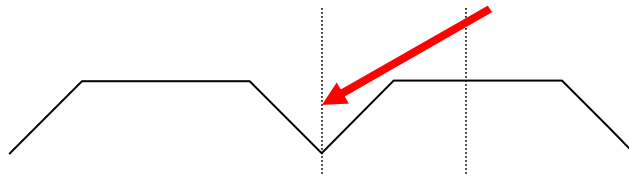
Figure 4 -- *crónica* → *corónica* ‘chronicle’

In these cases, however, the new vowel is a copy vowel in that it is always the same vowel as the nuclear vowel in the demisyllable.

4.2.2 C_1 voicing

The reader will recall that two of the five variables were noted as having statistically significant results. With reference to voicing, we know that voiced consonants are shorter in duration than their voiceless counterparts. Thus, given its shorter duration, only the release of the gesture extends into the Phase Window, resulting in longer SV duration; meanwhile, given its longer duration,

the voiceless consonant extends further into the Phase Window, as shown in Figures 5 and 6:

Figure 5 – Voiced C_1

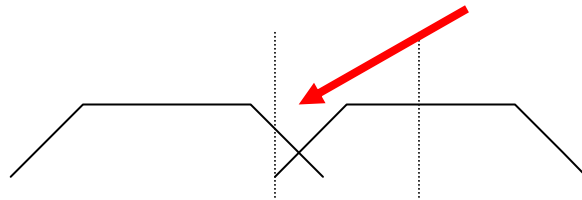
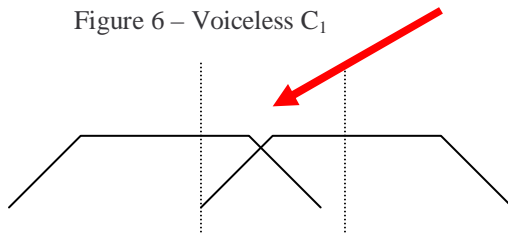

Figure 6 – Voiceless C_1



Notice that in both Figures 5 and 6, the two gestures intersect within the Phase Window, therefore, an SV would be perceived, though in obviously different durations. AP is particularly efficient in such cases as we are able to represent SV duration in such a precise fashion.

4.2.3 Order of Constriction³

With regard to order of constriction, we found that a back-to-front order of constriction results in longer SV duration than front-to-back. The effects of the back-to-front constriction order in C_1 involve articulatory differences in stop release. The contact area is more extended in velar stops than in labial or alveolar ones (Cho & Ladefoged, 1999: 211), and the back of the tongue moves slower than the tongue tip or the lips (Hardcastle, 1973: 266). This means that velar consonants typically have a longer release, which increases the temporal distance between its constriction and that of the following /r/, as seen in Figure 7:

Figure 7 – Back-to-Front Order of Constriction

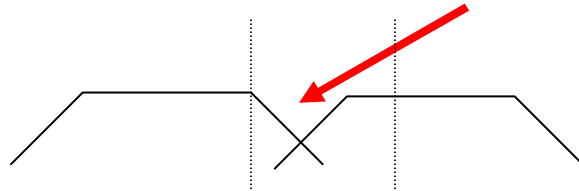

Lastly, in the cases of front-to-back order of constriction, seen in Figure 8, the C_1 gesture extends further into the Phase Window with the result of an SV that is shorter than the one seen in Figure 7:

Figure 8 -- Front-to-Back Order of Constriction

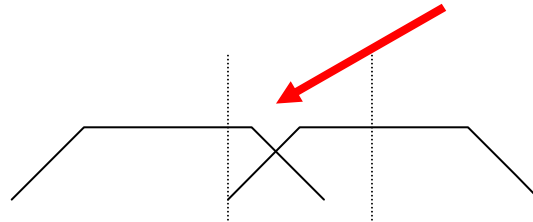

5. Conclusion

In sum, the goal of this investigation has been to test the five hypotheses set forth by Bradley and Schmeiser (2003) with empirical data in an attempt to capture any tendencies regarding SV duration. The data compiled in this study seem to suggest that SV duration, though no doubt quite variable, is not as random as once thought. Moreover, this investigation also corroborates Blecua's (2001) study in that rhotics (SVs included) were longer after voiced consonants. However, my findings differ from hers in that place of articulation was relevant in my study, but not in hers.

Pertaining to further research, Blecua (2001) found that manner of articulation was relevant in her study, however it was not directly tested in this study. That is, though I did analyze voicing (i.e. approximants and voiced stops vs. voiceless stops and the fricative /f/), I did not look at each of the four manners of articulation as she did. Regarding manner of articulation, she went on to offer an implicational relationship hypothesis in which as the duration of C_1 increases, the duration of the rhotic (SV + tap) decreases. Provided that she found manner of articulation to be relevant, her implicational hypothesis must be tested with

further empirical data, which is the logical course for further research in this matter.

Notes

*I wish to thank the members of the WECOL readers for their helpful comments regarding the original abstract. My gratitude goes to the members of the audience for their insightful questions. Heartfelt thanks to Travis Bradley for his guidance and invaluable feedback.

1. The total number of tokens was 165, however in six cases the audio quality was not ideal.
2. The first gesture is adjusted and the second gesture remains in the fixed location given that, as Blecua (2001) points out, the tap gesture is less variable and the C₁ is more variable in terms of duration.
3. Note that, in the cases of order of constriction, an area of further investigation is to separate both front-to-back and back-to-front variables in terms of voice in order to ascertain its effects.

References

- Blecua Falgueras, Beatriz. 2001. *Las vibrantes del español: manifestaciones acústicas procesos fonéticos*. Ph.D. dissertation. Universidad Autónoma de Barcelona.
- Bradley, Travis G., & Benjamin Schmeiser. 2003. "On the phonetic reality of /r/ in Spanish complex onsets." *Selected Proceedings of The Sixth Hispanic Linguistics Symposium* ed. by Paula M. Kempchinsky, Judith Liskin-Gasparro & Carlos-Eduardo Piñeros, 1-20. Somerville, MA: Cascadilla Press.
- Browman, Catherine and Louis Goldstein. 1986. "Towards an articulatory phonology," *Phonology Yearbook*, **3**: 219-252.
- Browman, Catherine and Louis Goldstein. 1988. "Some notes on syllable structure in Articulatory Phonology," *Phonetica*, **45**: 140-155.
- Browman, Catherine and Louis Goldstein. 1989. "Articulatory gestures as phonological units," *Phonology*, **6**: 201-251.
- Browman, Catherine and Louis Goldstein. 1990a. Gestural specification using dynamically-defined articulatory structures. *Journal of Phonetics*, **18**: 299-320.
- Browman, Catherine and Louis Goldstein. 1992. "Articulatory Phonology: An overview," *Phonetica*, **49**: 155-180.
- Byrd, Dani. 1996a. "A phase window framework for articulatory timing," *Phonology*, **13**: 139-169.
- Byrd, Dani. 1996b. "Influences on articulatory timing in consonant sequences." *Journal of Phonetics*, **24**: 209-224.
- Cho, Taehong, & Peter Ladefoged. 1999. "Variation and universals in VOT: Evidence from 18 languages." *Journal of Phonetics*, **27**: 207-229.
- Gafos, Adamantios. 1999. *The articulatory basis of locality in phonology*. New York: Garland.

- Gafos, Adamantios. 2002. "A grammar of gestural coordination," *Natural Language and Linguistic Theory*, **20.2**: 269-337.
- Gili Gaya, Samuel. 1921. "La r simple en la pronunciación española," *Revista de Filología Española*, **8**: 271-280.
- Hardcastle, W. J. 1973. "Some observations on the tense-lax distinction in initial Stops in Korean." *Journal of Phonetics*, **1**: 263-271.
- Lenz, Rodolfo. 1892. "Chilenische Studien," *Phonetische Studien*, **5**: 272-293.
- Malmberg, Bertil. 1965. *Estudios de fonética hispánica*. (= *Collectanea Phonetica*, I.) Madrid: Consejo Superior de Investigaciones Científicas.
- Navarro Tomás, Tomás. 1918. "Diferencias de duración entre las consonantes españolas," *Revista de Filología Española*, **5**: 367-393.
- Quilis, Antonio. 1988. *Fonética acústica de la lengua española*. Madrid: Editorial Gredos.

Extended-Projection, Categorization, and the English Morpheme *-Ing*

David Schueler

University of California, Los Angeles

1. Introduction

In this paper I will propose a characterization for the morpheme *-ing* in three verbal nominalizations: Ing-of, Poss-ing, and Acc-ing. I will suggest that the morpheme *-ing* takes a verbal (extended) projection, such as V, Asp, T, Agr, and changes it into a nominal (extended) projection. I base my characterization of extended projections on Grimshaw (2000), though I employ different assumptions.

Three constructions in particular will be investigated. In (1) we have Ing-of, the most productive nominalization in English, characterized by a possessive marking for the subject, if any, and marking of the object with the preposition *of*. In (2) is Poss-ing, with possessive marking for the subject (which is obligatory; cf. (2c)), but accusative marking for the object. In (3) is Acc-ing, with accusative marking for both the subject and the object.

(1) Ing-of (also called “derived nominalizations” or “mixed nominalizations”):

- a. His calling of the girl bothers me.
- b. The calling of the girl bothers me.
- c. John’s calling of the girl bothers me.

(2) Poss-ing (often simply called “gerunds”):

- a. His calling the girl bothers me.
- b. John’s calling the girl bothers me.
- c. *The calling the girl bothers me.

(3) Acc-ing (also called “clausal gerunds”, “NP-ing”)

- a. Him calling the girl bothers me.
- b. John calling the girl bothers me.

I will not consider Progressive *-ing*, as in (4), in this paper. Its properties are different, and although some authors, most notably Milsark (1988), have attempted to unify the progressive *-ing* with the gerundive *-ing*, I will not pursue this idea here.

(4) John is calling the girl.

In addition, I will only briefly mention PRO-ing, as in (5). PRO-ing is most likely similar in structure to either Acc-ing or Poss-ing; Abney (1987) favors the former.

(5) PRO Calling the girl would be a good idea.

I will suggest that all three of these nominalizations: Acc-ing, Poss-ing, and Ing-of, are derived by a category-changing morpheme *-ing*. The difference between the constructions hinges on where in the clause *-ing* is merged, and what {F}-level (Shell-level in Grimshaw (1991)) it projects.

My proposal is that *-ing* is flexible as to on which {F}-level (“shell-level” in Grimshaw (1991)) it enters the derivation, but must project a category within the same {F}-level.

By hypothesis, the {F}-level structure of the clause (verbal extended projection) is something like (6).

(6) (preliminary)

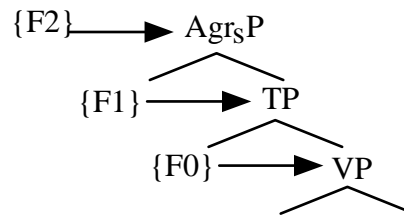

An {F}-level is the “functional level” of a head. For example, V is a lexical head, so it has a 0 {F}-level. By contrast, T, in (6), is a functional level merged right on top of V, so it has {F}-level 1. Agr_s is merged on top of T, so it is further into the functional layer, so it has an {F}-level of 2.

The {F}-level structure of the DP, by contrast, is something like (7).

(7) (preliminary)

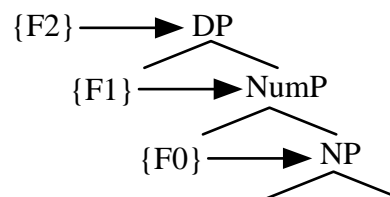

Here, N is the lexical head for a noun phrase, so it has {F}-level 0. Num is the functional category next merged, so it has {F}-level 1.

It should be noted that I consider the actual merge order, and the inventory itself, of functional heads to be an open research question. The orders I present in this paper yield sensible results for gerunds, but there may well be more heads in the structure, and some may occur in slightly different orders than those I present. Additionally, there may be cross-linguistic variation.

However, the hypothesis that there is a correspondence between the verbal projections and the nominal projections is crucial. In (6) and (7), we have N corresponding to V (both shell level 0), Num corresponding to T (both shell level 1), and D corresponding to Agr_s (both shell level 2). There may be different correspondences at work here, as I will show later in the paper, but the existence of some correspondence of this type is at the heart of the proposal.

The attachment possibilities of *-ing* are outlined in (8) through (16). Note that as soon as *-ing* projects its nominal category, further nominal heads will be merged on top until the phrase is closed as a DP. This is the essence of my proposal for *-ing*; it retains the shell level of its complement, but projects a functional (or lexical) category of the nominal type.

The proposal that *-ing* has a flexible {F}-level is reminiscent of Thráinsson (1993), who proposes that the morpheme *að* can merge as a C, an Agr_s, or a T, depending on what it takes as a complement. The difference here is that *að* is always a member of the *verbal* extended projection, and takes a complement also on the *verbal* extended projection; further, it projects the next {F}-level up from its complement, rather than the same {F}-level as that of its complement

So the structure of Ing-of is as in (8).

(8) Ing-of

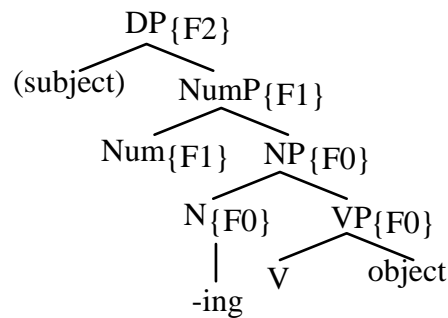

This structure predicts that adjectives should be allowed before the NP in Ing-of, since there is an NP node present. This is indeed the case, as seen in (9); see also section 3.

(9) John's quick calling of the girl helped him.

For Poss-ing, the *-ing* will take the TP as complement, which is {F}-level 1. Therefore, *-ing* must project an {F}-level-1 nominal category, which I propose is NumP.

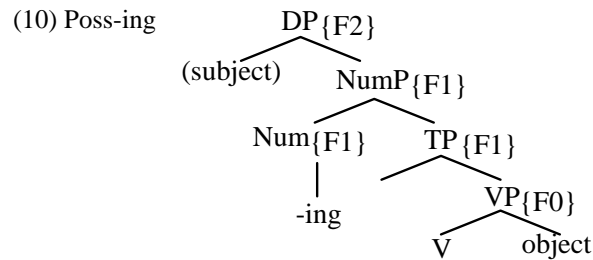

This predicts that Poss-ing, unlike Ing-of, will allow adverbs but not adjectives to modify the lexical head:

(11) John's quickly/*quick calling the girl helped him.

For Acc-ing, the preliminary structure, which we will reject, would be (12).

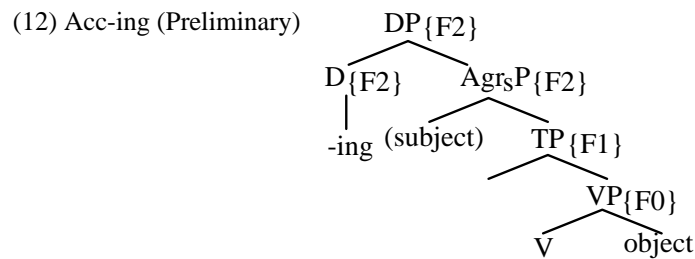

The problem with this option is that the subject in Acc-ing does not agree with the verb, nor receive nominative case, both properties normally associated with the Agr_s projection.

- (13) a. Him coming late bothers me.
 b. *He coming late bothers me.
 c. *Him/He come-s-ing late bothers me.

Therefore, we need a structure for Acc-ing which does not include the Agr_s projection. Cardinaletti (2004) suggests, as an analysis of Icelandic “quirky case” and other phenomena, that the position of a subject and the head responsible for agreement and assignment of nominative case are two different heads; the Agr_sP is split into two heads: NomP for agreement and nominative case as-

signment, and SubjP for licensing of the subject. (See also Koopman (2004) for further discussion of this hypothesis.)

For English, we can propose that the order of merger of these is NomP >> SubjP, as in (14) and for Acc-ing, *-ing* enters at the SubjP level, thus allowing a subject to be licensed but not allowing it to receive nominative case.

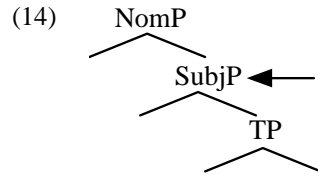

We will have to assume that SubjP is at a different {F}-level than NomP, and that *-ing* can take SubjP but not NomP as complement.

Thus, even this *-ing* may not be at the highest {F}-level for a DP. I propose that there is a parallel split in the DP level, with two categories corresponding to what we assumed was the D level. I symbolize the lower level as D^{-1} . So the new hierarchies of {F}-levels, for the clause and for DP, are as in (15), and the structure of Acc-ing is as in (16).

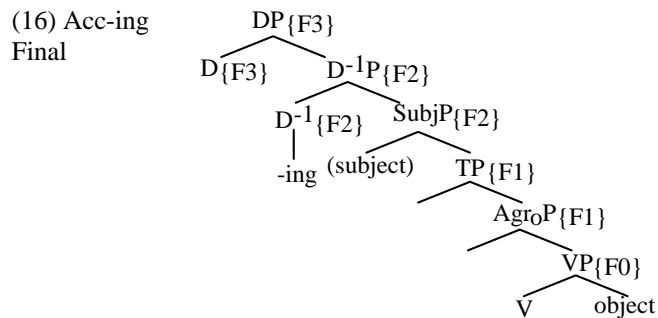
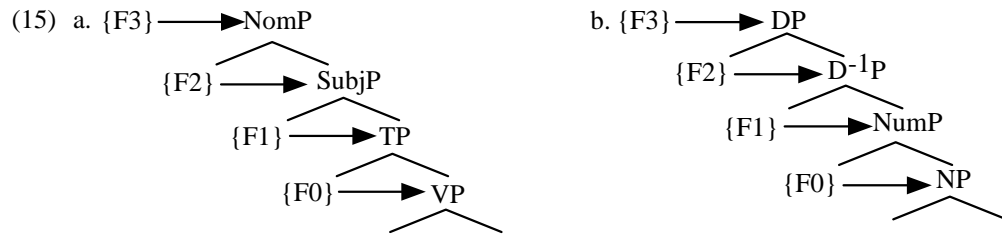

We must assume that *-ing* cannot take NomP as complement. This restriction seems unproblematic, since we already know that *-ing* has to be constrained not

to merge as high as CP, for example. Since the subject is licensed, but does not get assigned case, it will receive the default case for English (Schütze 2001), which is accusative.

The rest of the paper is organized as follows. In section 2 I discuss two previous analyses of English gerunds, and explain why my analysis does not suffer from certain shortcomings that theirs do. In section 3 I show that my analysis predicts certain well-known facts about gerunds, such as patterns of adverb modification and number agreement. In section 4 I present new arguments that Acc-ing is a DP, as predicted by my analysis but contra other recent authors. Section 5 offers a brief conclusion. In section 6, the appendix, I present some further semantic puzzles dealing with the three types of gerunds.

2. Previous Analyses

2.1 Abney

Abney (1987) proposed that *-ing* is a morpheme unspecified for bar-level, which adjoins to maximal projections (IP, VP, V) and changes them to nominal projections (DP, NP, N respectively). Tree diagrams of Abney's proposals follow, changed to assume that 's is a D:

(17) Acc-ing:

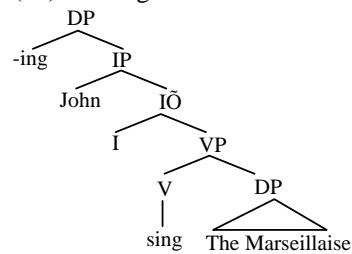

(18) Poss-ing:

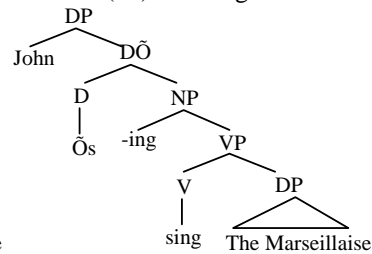

(19) Ing-of:

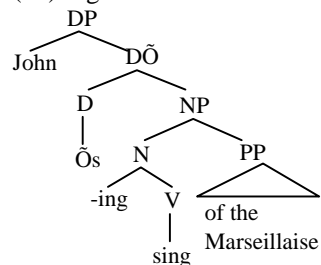

Abney proposes that *-ing* is underspecified for *bar*-level, and thus changes a V head to an N head in Ing-of (19), but changes a VP into an NP in Poss-ing (18). For Acc-ing (17), however, he presumably requires underspecification for the feature [\pm F], for “functional”, as well. Given this, it seems that he predicts a fourth construction where *-ing* changes an I head to D:

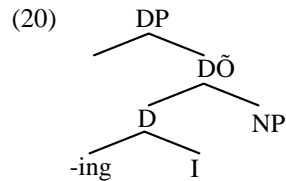

2.2 Milsark

Milsark (1988) proposes that *-ing* is a morpheme which adjoins to a V (only, in most cases), and can change it to any of the lexical categories: N, V, A, P. His goal is to unify even the progressive *-ing* with the gerundive *-ing*, as a single morpheme with a single morpheme.

Among gerunds, he considers only Poss-ing and Ing-of (and PRO-ing, which he equates structurally to Poss-ing), and his theory says that Poss-ing involves recategorization of Infl to N, whereas Ing-of involves recategorization of V to N. In this way, he does not seem to predict the impossibility of adjective modifiers in Poss-ing.

2.3 Comparison

My proposal is more in line with current assumptions within generative syntactic theory, including minimalist principles and X-bar theory, because:

a) I assume that *-ing* is always a head which takes a phrasal complement and projects a full x-bar clause

b) I do not require any special operation of recategorization or transformation, just the presence of clausal structure below *-ing* and nominal structure above *-ing*.

c) The only new stipulations I require are i) that *-ing* has a variable {F}-level, which is has a precedent in Thráinsson’s analysis of Icelandic, and ii) that *-ing* is constrained to project the {F}-level of its complement.

In addition, it is unclear that it is desirable to unify gerunds with the progressive. In particular, the progressive is limited to eventive verbs, and is incompatible with statives (21a), while the gerunds are not (21b-c).

- (21) a. *John is knowing the answer.
 b. John knowing the answer pleased me.
 c. John’s knowing the answer pleased me.

3. Some Familiar Facts

3.1 Adverbs

As was mentioned in section 1, Acc-ing and Poss-ing can occur with (preverbal) adverbs, whereas Ing-of cannot, and vice versa:

- (22) a. John/John's quickly/*quick playing the flute pleased the audience.
 b. John's quick/*quickly playing of the flute pleased the audience.

(22a) follows on the structures proposed for Acc-ing and Poss-ing, repeated below, since there is a VP present to attach an adverb to, but no NP to attach an adjective to. Note that I assume affix lowering of *-ing* for Poss-ing and Acc-ing:

(23) Poss-ing

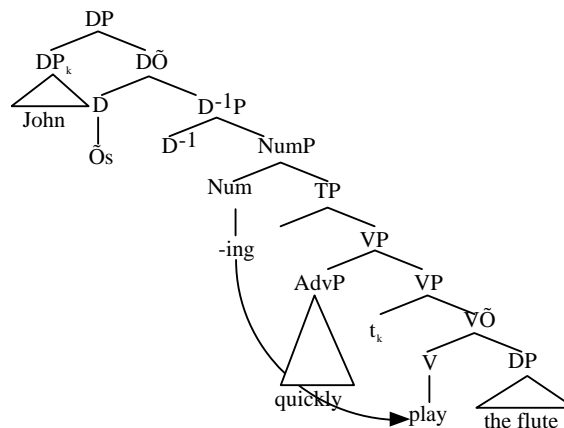

(24) Acc-ing

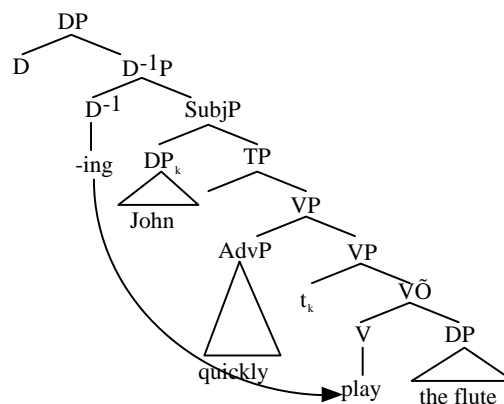

With regards to where *-ing* attaches in Poss-ing, there seems to be a dialect difference, based on the possibility of sentential adverbs in this construction.

(25) %I was worried about John's probably being a spy.

(26) %Mary's certainly being pregnant worries me.

Therefore, I propose that for some people *-ing* can attach at the Agr_oP level but not at the TP-level, while for others it can attach at the TP level. Since they result in a construction with a similar external distribution, I will assume that TP and Agr_oP are the same {F}-level. From now on I will write Agr_oP below TP in every structure.

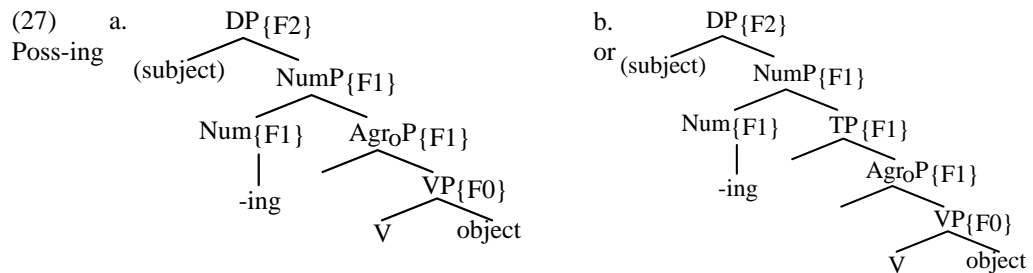

The situation with adverbs vs. adjectives in Ing-of (22b) is a little more complicated. Fu et al. (2001) note that we can have adverbs (but not sentential adverbs) *after* nominalized verb and its complements.

(28) a. John's singing of the song skillfully to Mary pleased me.

b. *John's singing of the song probably to Mary pleased me.

In Fu et al.'s analysis: There is a VP in such a process nominal:

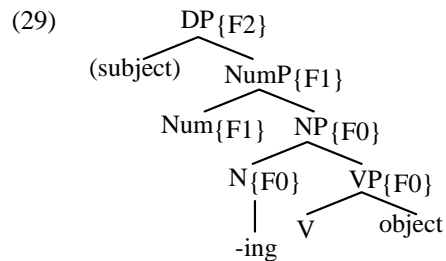

Note that this means that in Ing-of, the verb must undergo *overt head movement to -ing*, rather than *-ing* undergoing affix lowering as in Acc-ing and Poss-ing, to ensure that the adverbs must go on the right.

3.2 Number agreement

My analysis predicts, contra Abney, that both singular agreement and plural agreement should be possible for Acc-ing, but that only plural agreement should be possible for Poss-ing, at least to the extent that DPs in coordination must trigger plural agreement (cf. Safir 1983).

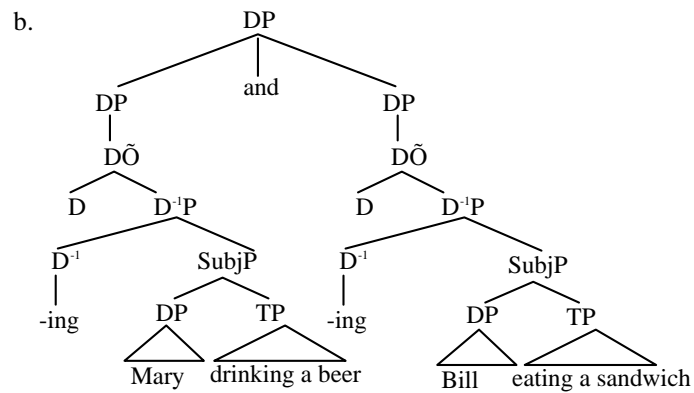
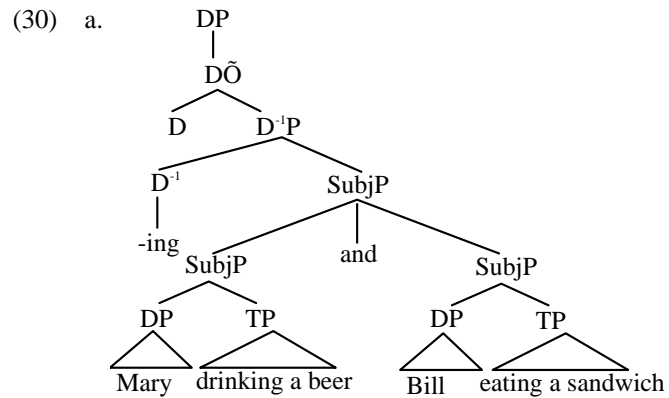

This seems tentatively supported; there is a semantic difference between the two agreement possibilities, corresponding to whether the two clauses constitute a single collective event, or are treated as separate events:

(31)a. Mary drinking a beer and Bill eating a sandwich usually last about 30 seconds.—different events

b. Mary drinking a beer and Bill eating a sandwich usually lasts about 30 seconds.—one event.

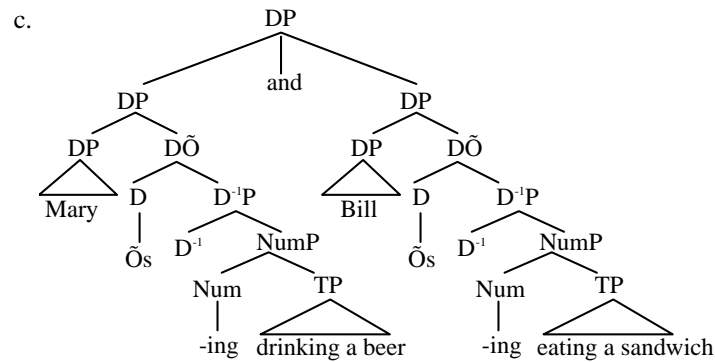

(32) a. Mary's drinking a beer and Bill's eating a sandwich usually last about 30 seconds.

b. ??Mary's drinking a beer and Bill's eating a sandwich usually lasts about 30 seconds.

4. Acc-ing is a DP

One controversial consequence of my proposal, although advocated by Abney (1987) and others, is that Acc-ing as well as Poss-ing is a DP. Reuland (1983), Johnson (1988), and Pires (2001), for example, argue that Acc-ing and PRO-ing are full clauses (TPs), headed by a *-ing*, which for them is an Infl-type morpheme which (exceptionally) has Case properties.

Their arguments are as follows:

A. Acc-ing allows sentential adverbs, but Poss-ing does not:

(33) %Mary's probably being responsible for the accident caused the attorney not to want to defend her.

My response to argument A is: 1) Some people find the sentential adverbs fine in Poss-ing. 2) For those for whom sentential adverbs are bad in Poss-ing, this can be explained by a lower attachment of *-ing*, that is, a position excluding TP.

B. Acc-ing allows wh-extraction out of it, while Poss-ing doesn't:

(34) (judgments Pires's) a. Who did you defend Bill inviting?
b. *What did you defend Bill's inviting?

This seems to show that Poss-ing patterns with DPs, while Acc-ing patterns with clauses:

- (35) a. Who do you believe that Bill invited?
 b. *Who do you the claim that Bill invited?

My response to B is that the judgments are finer grained than this. Extraction has partly to do with the (observable) syntax, but partly to do with the **presuppositionality** of the clause in question. (See section 4.1)

C. There is an animacy and specificity restriction on the subject position of Poss-ing, but not on that of Acc-ing:

- (36) Anyone/*Anyone's winning this prize would be unexpected.

My response to C is that this follows from the restrictions on the determiner 's; while the allowance of indefinites in Acc-ing follows from the presence of a clausal licensing position.

D. Acc-ing may take an expletive subject, while Poss-ing cannot.:

- (37) You may count on there/*there's being a lot of trouble tonight.

My response to D is that this also follows from the occurrence of a sentential subject position (SubjP) in Acc-ing, which has an EPP feature, but not in Poss-ing, which only has a Spec-DP position, which licenses a DP subject but doesn't itself need to be filled.

E. It is conceptually simpler to assume that Acc-ing does not involve "recategorization" of a clause into a DP, since it shows so many clausal properties.

My response to E is that this fails to take into account the need to also account for Poss-ing and Ing-of. *-ing-as-Infl* accounts aren't promising as accounts of Poss-ing or (especially) Ing-of. Note that it's probably not possible to assimilate the *-ing* of Acc-ing to Progressive *-ing* either, since the former does not have obligatory progressive aspect.

4.1 Extraction

In this section I argue that Acc-ing is harder to extract from if the clause is presuppositional. This suggests that Acc-ing has a DP node, which blocks extraction only when the DP is presupposed to exist. I will suggest that the other prominent readings of Acc-ing are *generic* readings.

(38) a.

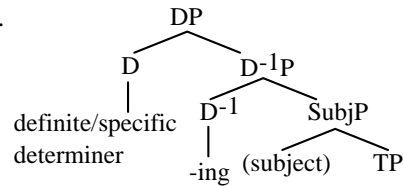

b.

or

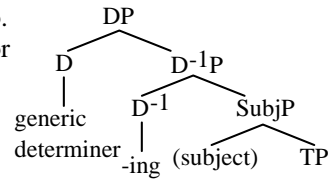

This contrasts with Poss-ing, which can only be headed by the determiner 's, due to the requirement that the subject receive genitive case (since there is no SubjP in the verbal structure). This in turn imposes definite/specific semantics on its clause.

(39)

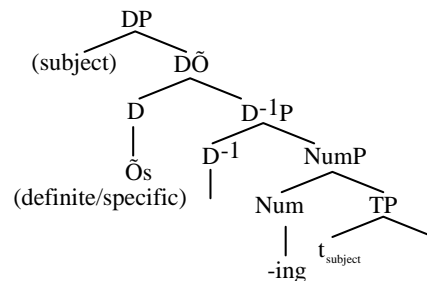

I suggest that the “definite/specific” determiner is parallel to *the*, while the “generic” determiner is the same as we see in generic readings of bare plurals. Note that extraction is good out of generic DPs, but not definite ones:

(40) a. *Who did you read the book about?

b. Who do you read books about?

So it is predicted that extraction should be good out of generic Acc-ing, but not presupposed Acc-ing.

Acc-ing allows three basic readings: habitual, factive, and hypothetical factive. These readings are biased, though perhaps not completely required, by (41a), (41b), and (41c) respectively:

(41) a. John likes Bill calling Sarah.

b. John liked Bill calling Sarah.

c. John would like Bill calling Sarah.

Note that the **habitual** reading is characterized by the possibility of multiple events, while the factive and hypothetical factive readings normally imply a single event. Nevertheless, I will assume that the hypothetical reading has a

similar determiner to the habitual reading. The semantics of the hypothetical reading is something like ‘In general, if Bill called Sarah, John *would* like it.’

The availability of the habitual reading depends on the predicate. A more heavily factive predicate like *regret* doesn’t allow it:

(42) John regrets Bill calling Sarah.

(42) does not have a habitual reading. However, with *would* we can force it to have a hypothetical reading:

(43) John would regret Bill calling Sarah.

With this in mind, let’s see what happens with extraction:

- (44) a. ?*Who does John regret Bill calling?
 b. ?Who would John regret Bill calling, if Bill were to call someone?

Here (44b) gets a little better. This is predicted if (44b) has Acc-ing with a generic determiner, as in (38b), while (44a) has a definite/specific determiner, as in (38a).

The conclusion of this discussion is that claiming that Acc-ing does not behave at all like a DP is inappropriate. Rather, Acc-ing and Poss-ing both behave like various types of DPs for extraction. Poss-ing almost always behaves like a possessed DP in argument position, while Acc-ing behaves sometimes like specific DPs and sometimes like nonspecific indefinite DPs.

This follows if Poss-ing is forced, by the Case requirements of the clausal subject, to always have the same D, ’s, while Acc-ing, since the subject is licensed within the nominalized clause, is allowed to have various D’s, some of which trigger presupposition (and hence difficulty for extraction), and some of which do not.

5. Conclusions

In this paper, I have suggested that a unified analysis of *-ing* for Acc-ing, Poss-ing and Ing-of is possible and desirable, and can account for most of the traditionally observed data. The new analysis is more in line with minimalist and X-bar principles than similar analyses proposed previously.

The analysis makes cross-linguistic predictions, that we should be able to find other morphemes with flexible {F}-level attachment, but they should be constrained to project the same {F}-level that they take as complement. This in turn predicts that we should see evidence from the outer distribution of a clause with a flexible morpheme that shows that only the amount of structure is present as

allowed by what {F}-level the morpheme has attached to. Likewise for the inner distribution.

New data concerning extraction and NPIs supports a structural difference between Acc-ing and infinitivals, and hence supports the idea that Acc-ing has a DP node, infinitivals having a TP node.

References

- Abney, Steven. 1987. *The English Noun Phrase in its Sentential Aspect*. Doctoral Dissertation, MIT.
- Cardinaletti, Anna. 2004. 'Towards a cartography of Subject Positions,' In L. Rizzi (ed.) *The Structure of CP and I: The Cartography of Syntactic Structures, vol. 2*, Oxford - New York: Oxford University Press,
- Fu, Jingqi, Thomas Roeper and Hagit Borer. 2001. 'The VP Within Process Nominals: Evidence from Adverbs and the VP Anaphor *Do-So*,' *Natural Language and Linguistic Theory*, **19**. 3: 549-582
- Grimshaw, Jane. 2000. 'Locality and Extended Projection,' in Coopmans, Peter, Martin Everaert, and Jane Grimshaw, eds. *Lexical Specification and Insertion*. Amsterdam/Philadelphia: John Benjamins.
- Grimshaw, Jane. 1991. 'Extended Projection.' ms. Brandeis University.
- Johnson, Kyle. 1988. 'Clausal gerunds, the ECP, and Government,' *Linguistic Inquiry*, **19**. 4: 583-609
- Koopman, Hilda. 2004. 'Agreement Configurations: In Defense of Spec Head.' Ms. UCLA.
- Milsark, Gary. 1988. 'Singl-ing,' *Linguistic Inquiry*, **19**. 4: 611-634
- Pires, Acrisio. 2001. *The Syntax of Gerunds and Infinitives: Subject, Case and Control*. Doctoral Dissertation. University of Maryland, College Park.
- Reuland, Eric. 1983. 'Governing -ing,' *Linguistic Inquiry*, **14**. 1: 101-136
- Safir, Ken. 1983. 'Small clauses as constituents,' *Linguistic Inquiry*, **14**. 4: 730-735
- Schütze, Carson. 2001. 'On the Nature of Default Case,' *Syntax*, **4**. 3: 205-238
- Thráinsson, Höskuldur. 1993. 'On the Structure of Infinitival Complements,' in Höskuldur Thráinsson, Samuel D. Epstein and Susumu Kuno, eds. *Harvard Working Papers in Linguistics*, **3**. Cambridge, MA: Department of Linguistics, Harvard University,

David Schueler
University of California, Los Angeles
daschuel@humnet.ucla.edu

Are Scalar Implicatures Computed Online?

Gianluca Storto and Michael K. Tanenhaus

University of Rochester

1. Introduction: Scalar Implicatures

Since Horn (1972) the notion of conversational implicature proposed by Grice has been put to use to explain certain interpretive differences between expressions in natural language and their counterparts in formal logic. For example, the sentences in (1) seem to convey more than they would be expected to if the natural language disjunction or had the same meaning as the logical disjunction \vee , or if the quantificational determiner some was interpreted as the existential quantifier \exists .

- (1) a. Uli or Philippe asked questions after the talk.
 \rightsquigarrow Uli or Philippe asked questions after the talk, but not both.
- b. Some students in the audience liked the talk.
 \rightsquigarrow Some students in the audience liked the talk, but not all.

The intuitive meaning of the sentences in (1) imposes restrictions (the material underlined in the glosses) that go beyond the meaning of logical disjunction or existential quantification: in formal logic, $P \vee Q$ is true if both disjuncts are, and $\exists xP(x)$ is true if the P holds of all entities in the domain of quantification.

Horn proposes that the additional restrictions that seem to characterize sentences like those in (1) are not part of the lexical semantics of or and some, which does not differ from that of their logical counterparts. These additional restrictions associated with uses of or and some are implicatures, part of the pragmatic “overlay” that arises as a consequence of general rational cooperative behavior principles when natural language is used in conversational exchanges. In particular, the non-logical interpretation of or and some is due to a class of inferences that follow from Grice’s first maxim of Quantity: “Make your contribution as informative as required for the current purpose of the exchange.”

Horn points out that many expressions in natural language can be ordered into *linguistic scales*, i.e. sets of expressions of the same grammatical category that can be arranged in a linear order by degree of informativeness or semantic strength (2).

(2) *Linguistic Scales*

Ordered sets of expressions $\langle \alpha, \beta, \gamma, \dots, \omega \rangle$, where by substituting α, β, γ , etc.

in a sentential frame ϕ we obtain well-formed sentences $\phi(\alpha)$, $\phi(\beta)$, $\phi(\gamma)$, etc.
 s.t. $\phi(\alpha)$ asymmetrically entails $\phi(\beta)$, $\phi(\beta)$ asymmetrically entails $\phi(\gamma)$, etc.

If, as Grice argues, speakers routinely abide to conversational maxims like Quantity and take their interlocutors to do the same, use of a lower element on a linguistic scale implicates that the speaker is not in the position of using some higher (= stronger) element of the scale. In particular, uses of *or* or *some*, which share the property of being the weaker element in the linguistic scales $\langle \text{and, or} \rangle$ and $\langle \text{all, some} \rangle$, implicate that the speaker is not in the position of uttering the stronger statement containing *and* or *all*. Under the common assumption that the speaker's knowledge of the subject matter of the conversation is not incomplete, this *scalar implicature* conveys that the stronger sentence containing *and* or *all* is false. Hence uses of *or* convey but not both, and uses of *some* convey but not all.

As Bach (to appear, p.8) points out, "Grice did not intend his account of how implicatures are recognized as a psychological theory or even as a cognitive model. He intended it as a rational reconstruction. [...] He was not foolishly engaged in psychological speculation about the nature of *or* even the temporal sequence of the cognitive processes that implements that logic." Still, the misconception that implicatures in general, and scalar implicatures in particular, are late-arriving inferences which can be calculated only at later stages in the comprehension of a sentence is rather pervasive in the pragmatic literature.

Surprisingly, the issue has not received much attention in the experimental processing literature. In the few recent contributions that address the processing of scalar implicatures in adults (Breheny and Katsos, 2003; Chierchia et al., 2003; Noveck and Posada, 2003; Bott and Noveck, 2004), the phenomenon is probed offline, i.e. well after scalar items like *or* and *some* are presented to participants.

2. Methodology

2.1 Experimental hypothesis

In this work, we aim at probing directly the timecourse of the computation of scalar implicatures, trying to determine whether this component of meaning is available at initial stages of processing or becomes available only at later stages. In particular, we focus on the $\langle \text{and, or} \rangle$ scale, testing the hypothesis that the exclusive component of the interpretation that is usually attributed to sentences containing a disjunction is computed and integrated very *locally* to the utterance of *or*.

By saying that the exclusive meaning of *or* is calculated and integrated 'locally' to the utterance of the disjunction we mean the following. As an utterance unfolds, listeners try to integrate the information that can be extracted from what they have already heard into a (partial) representation of the content conveyed by the utterance. In particular, listeners access the information provided by the lexical meaning of words that they have heard. The integration of the lexical meaning of

words is the paradigm of a very local process: as soon as a word is heard its lexical meaning (if known) becomes available and can be put to use. Our experimental hypothesis amounts to claiming that the implicated content that is associated with uses of the disjunction or does not differ much from lexical content. Like lexical content, the exclusive meaning of or should be “closely tied” to the utterance of this lexical item and become available as soon as the disjunction is heard.

In order to test this hypothesis, we adopt the so-called *visual-world eye-tracking experimental paradigm* (Tanenhaus et al., 1995). Within this paradigm subjects’ gaze constitutes the dependent measure. Using a head-mounted eyetracker, gaze is tracked while subjects hear linguistic stimuli instructing them to perform actions on objects that are part of a “visual world” of reference—an array of actual objects or a display on a computer screen—which is concurrently presented to them.

The experimental paradigm builds on the observation that, when instructed to interact with an array of objects, subjects fixate the intended target of action significantly more often than other objects in the array (Eberhard et al., 1995). Thus, that a subject fixates one object in a given array significantly more often than the rest can be taken as an indication that the subject has uniquely identified the intended target of action. Of course, whether the intended target can be uniquely identified depends on both the nature of the instruction received and on the nature of the array of objects. In particular, if the interpretation of the instruction is determined in an incremental way, changes in the nature of the array of objects could potentially change the *point of disambiguation*, i.e. the point at which the instruction has provided sufficient information to identify the intended target of action. The nature of the array of objects presented to the subject, thus, can be manipulated in order to test specific hypotheses on the processing of linguistic stimuli.

The behavioral measure provided by the visual-world paradigm is closely time-locked to the auditory stimulus. Subjects typically launch eye movements to the intended target of action within 500msec after the onset of the disambiguating word. Given that a latency of about 200msec occurs between the programming and the launch of eye movements (Matin et al., 1993), subjects initiate saccades to the target of action within 300msec from the onset of the disambiguating word.

2.2 The logic of the experiment

It is probably easier to understand the logic of our experiment by looking first at a case in which only lexical meaning is at stake. Consider the meaning of the conjunction and (3). A conjunction of NPs in subject position denotes a function of type $\langle et, t \rangle$, which returns the value TRUE if applied to properties that hold of the denotation of both conjuncts. Essentially, understanding the meaning a conjunction of NPs in the subject position of a sentence amounts to knowing that the property denoted by the VP holds of both conjuncts.

(3) $\llbracket \text{and} \rrbracket = \lambda B \lambda A \lambda P [A(P) \wedge B(P)] \quad \rightsquigarrow$ look for a property shared by the conjuncts

If this information is integrated as soon as *and* is heard, we should be able to change the point of disambiguation in sentences containing a conjunction of NPs as subject by changing the number of properties shared by the objects denoted by the two conjuncts. In particular, if the only relevant properties are being next to certain or other types of objects, changing whether the squares marked with A and B in the display in Figure 1 (center) contain objects of the same type or of different types should have quite a dramatic effect on the point of disambiguation for sentence-instruction pairs like the one in (4).

(4) The bananas and the grapes are next to some locks. Please click on those locks.

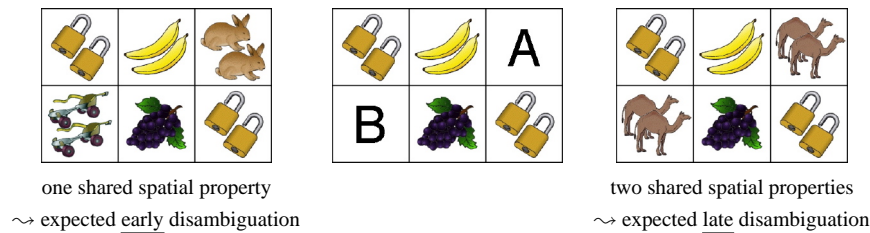

Figure 1: The logic of the experiment for the case of *and*

When the the objects in A and B are of different types (as in the display on the left in Figure 1), the bananas and the grapes share only the property of being next to some locks. If subject expect the follow-up instruction to ask them to perform some action on the objects mentioned in the VP of the first sentence, they should be able to uniquely identify the intended target of action already after having heard the conjunction *and* in the first sentence, i.e. before the intended target of action is mentioned at all. Conversely, when the objects in A and B are of the same type (as in the display on the right in Figure 1), the bananas and the grapes share both the property of being next to some lock and the property of being next to some camels. In this situation the integration of the meaning of *and* would not help subjects to identify the intended target of action, which could be distinguished from the other objects in the display only after being mentioned explicitly.

The same logic can be applied in investigating whether the exclusive meaning of *or* is integrated locally. Consider (5), where the exclusive component of the meaning of *or* is written directly into the lexical meaning of the disjunction. According to (5), a disjunction of NPs in subject position denotes a function of type $\langle et, t \rangle$ which returns the value TRUE if applied to properties that do not hold of both disjuncts, i.e. that differentiate the two. If this information is integrated as soon as *or* is heard, we should again be able to change the point of disambiguation of sentences containing a disjunction of NPs as subject by changing the number of properties shared by the objects denoted by the two disjuncts.

$$(5) \llbracket \text{or} \rrbracket = \lambda B \lambda A \lambda P [\mathcal{A}(P) \vee \mathcal{B}(P) \ \& \ \neg(\mathcal{A}(P) \wedge \mathcal{B}(P))]$$

↪ look for a property that distinguishes the disjuncts

Once again, changing whether the squares marked with A and B in the display in Figure 2 (center) contain objects of the same type or of different types should affect the point of disambiguation for sentence-instruction pairs like the one in (6).

(6) The grapes or the oranges are next to some locks. Please click on those locks.

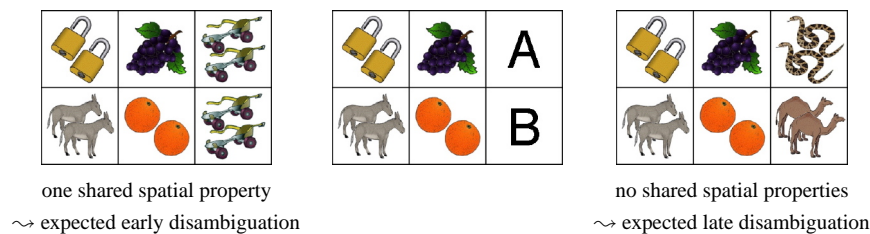

Figure 2: The logic of the experiment for the case of or

Leaving empty properties aside, the function denoted by exclusive or is the complement of the function denoted by and: every nonempty set that is mapped to TRUE by ‘NP₁ or NP₂’ is mapped to FALSE by ‘NP₁ and NP₂’, and viceversa. This means that if the objects in A and B are of the same type (as in the display on the left in Figure 2), subjects should be led to disregard them as possible targets of action already after having heard the disjunction or in the first sentence. While this does not by itself uniquely identify the intended target of action—until hearing locks two alternatives remain open—the integration of the exclusive meaning of or should be reflected in an increase in looks to the two remaining potential targets of action. Conversely, when the objects in A and B are of different types (as in the display on the right in Figure 2) the integration of the exclusive meaning of or would not help subjects in “narrowing down” the set of potential targets of action, and looks should be more equally distributed among the four possible alternatives.

Crucially, only the local integration of the *exclusive* meaning of or is expected to distinguish between the display on the left and the display on the right in Figure 2. If the exclusive component of its meaning is calculated only at a later point in the processing of sentences like (6), or should be initially given the same *inclusive* interpretation as the logical disjunction \vee , an interpretation that would not exclude the roller skates as potential intended targets of action in the display on the left.

This experimental design allows us to probe the interpretation of or without setting up an explicit verification task, where subjects would be asked to consciously evaluate the interpretation(s) licensed by a sentence containing the disjunction. Behavioral data from such tasks likely conflate and confound the participants’

processing of the linguistic stimuli with the verification strategy adopted to perform the task. In addition, explicit verification tasks might encourage subjects to consider from the start interpretations that would not be considered otherwise.

2.3 A summary: Experimental conditions and predictions

Before describing further details, let us summarize the various experimental conditions and the predictions that follow from our experimental hypothesis.

We first investigate the effects of the integration of lexical content using the paradigm detailed for the case of *and* above. This preliminary step is essential in order to test that our experimental methodology works. Indeed, results like those in Eberhard et al. (1995) concern primarily the effects of the integration of the meaning of open-class content words—adjectives, in particular—rather than more “functional” close-class words like *and* or *or*. Furthermore, the methodology that we adopt departs slightly from the basic visual-world paradigm: we are interested in tracking the participants’ gaze while they hear a sentence that describes the visual display, rather than while being instructed to perform an action. Still, in our design subjects must process the first sentence in order to identify which objects the action requested by the following instruction should be performed on. We expect to replicate the basic results of the visual-world paradigm within this setting.

For the case of *and* we consider two conditions: an early disambiguation condition (AE), where we expect the integration of the meaning of the conjunction to help subjects in identifying the intended target of action already before it is mentioned in the VP of the sentence, and a late disambiguation condition (AL), where we expect the intended target of action to remain ambiguous until its mention.



Figure 3: The 5 experimental conditions

Then, we test whether the effects that we expect to find in the case of *and* can be reproduced for the case of *or*, using the same logic detailed above. As in the case of *and*, we have two basic conditions for *or*: an early disambiguation condition (OE), and a late disambiguation condition (OL). In addition, we introduce a third condition (OI), which resembles the early disambiguation condition in that the same kind of displays are used, but which differs from it in that the two identical objects in the display are mentioned in the auditory stimuli as intended targets of action. Items of this sort, in which the disjunction in the first sentence must be interpreted as inclusive, are needed in order to avoid biasing subjects towards an exclusive interpretation of *or*. But these items are not mere fillers. Given our hypothesis that subjects should initially be driven away from shared properties by

the exclusive meaning of *or*, we might expect a further disambiguation delay in the OI condition, similar to the syntactic garden-path effects discussed in the literature.

3. The Experiment

3.1 Methods

3.1.1 Materials

The actual displays in the experimental materials consisted of 3×3 square grids containing 9 (pairs of) objects. Adding a third row in the display was necessary to ensure that subjects had to process the first sentence in order to correctly perform the action requested by the follow-up instruction. If the simpler displays shown in the previous section had been used, subjects could have easily adopted a heuristic—“click on objects of the type mentioned in the VP of the first sentence”—that would have allowed them to perform correctly the requested action without actually paying attention to the meaning of the conjunction/disjunction in subject position. With the more complex display, we can ensure that subjects process the first sentence: the third row contains an additional pair of objects of the type mentioned. Consider the two alternative sentence-instruction sequences in (7) with respect to the display in Figure 4: those and other in the instructions can be interpreted only with respect to the first sentence.¹

- (7) The bananas and the grapes are next to some locks.
- a. Please click on those locks.
 - b. Please click on some other locks.

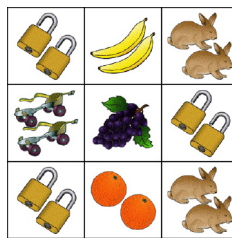

Figure 4: An example of the full 3×3 grid displayed in a trial

The pairs of objects used in the displays were constructed using images from the color Snodgrass picture set (Rossion and Pourtois, 2004). The central column remained constant across all displays. The other two columns contained pictures chosen among the eight pairs of objects in Figure 5.

We chose to consider as experimental items only displays where the objects denoted by the subject of the first sentence are in contiguous rows. For each of the



Figure 5: The 8 pairs of objects used in the experiment

AL, AE, OL, and OE conditions 4 items were created. The OI condition consisted of 8 items, in order to offset the exclusive interpretation of or required by the OL and OE conditions. In half of the experimental items the third row appears above the two relevant rows, and in the other half it appears below them. 12 filler items were created that are essentially identical to experimental items but for the fact that the two rows referred to by the subject of the first sentence are not contiguous. In addition 12 more filler items were created in which sentences like (8) are used to describe displays like those used in experimental items. Finally, 64 filler items were created for which sentences like those in (9) are used as descriptions of the visual display. Altogether, the set of test items consisted of 112 items.

(8) Some locks are next to the bananas and/or the grapes.

(9) a. The bananas are next to some locks.

b. Some locks are next to the bananas.

Care was paid in balancing this set as evenly as possible. All eight objects appeared as intended targets the same number of times,² and overall all objects occurred equally often in the set of test items. Four different lists of experimental items were created. The 8 objects in Figure 5 were divided in two sets in order to ensure that different objects appeared as intended targets in the 4 AL/OL vs. the 4 AE/OE items, and one factor of difference between the lists was which set was used in which condition. Balancing the distribution of the intended targets of action and the remaining “alternative” objects among the 4 possible cells available in the grid would have required to create 8 items per condition. We chose to divide the possible layouts in two sets, and have the choice between these two sets be the second factor of difference between the four lists of experimental items. Finally, the order of mention of objects in the conjunctions and disjunctions in the first sentence in the auditory stimuli was balanced too, as was whether the follow-up instruction designated as target of action objects in the rows referred to by the subject of the first sentence or the relevant object in the third row.

3.1.2 Participants

Participants were sixteen (16) male and female undergraduates from the University of Rochester Department of Brain and Cognitive Sciences subject pool, who were paid for their participation.³ All participants were native speakers of North American English with normal or corrected to normal vision and no hearing impairments. Participants were equally distributed among the four lists of materials.

3.1.3 Procedure

The experimental materials were presented using an Apple eMac computer with a 17-inch monitor (1024×768 pixel resolution) and external stereo loudspeakers. During the experiment participants were seated about 30 inches away from the computer monitor. Each trial began with the presentation of a number at the center of the blank screen. After 500msec the number disappeared and a 3×3 square grid (768×768 pixels) containing 9 (pairs of) objects was displayed. After 3 seconds the first sentence—e.g. The bananas and the grapes are next to some locks—was played, followed by a 300msec pause and then by the follow-up instruction—e.g. Please click on those locks. After performing the requested action, participants pressed the spacebar to go to the next trial.

Before testing proper, subjects were presented with four practice trials in order to familiarize with the task to be performed. Practice trials differed from the trials in the testing phase in that objects other than those in Figure 5 were used in the visual displays, and in that subjects received explicit feedback on their performance in the follow-up task. A PsyScope script (Cohen et al., 1993) controlled the presentation of the stimuli and recorded the subjects' performance in the follow-up task. The 112 items in the testing phase were presented in random order in one block (subjects were allowed to take breaks between trials). A run of the experiment took on average about 30 minutes.

Participants' eye movements were monitored using an ISCAN EC-501 head-mounted eyetracker. An eye camera provides an infrared image of the eye and tracks its position by analyzing the positions of the center of the pupil and the first Purkinje reflection. A scene camera is aligned with the participant's line of sight, providing a context with respect to which eye position data is localized. Output from the scene camera, along with a superimposed crosshair marking point of gaze, and the audio signal, were recorded for the whole experiment using a Sony Digital-8 professional editing VCR. Audio and video signals were synchronized; the recording camera samples at a rate of 30 frames per second and each video frame was stamped with a time code. Eye-tracker calibration was monitored and adjusted as necessary by the experimenter between trials.

For experimental trials, a frame-by-frame editing VCR was used to identify looks to the 9 cells on the screen. Coders did not know which cells contained intended targets of fixation, nor did they hear the auditory stimuli. Automatic post-processing of the coded data identified the objects fixated in each trial.

3.2 The case of and

3.2.1 Results

The results are expressed here as fixation proportions over time, pooling across all trials falling into a given condition. The graphs in Figure 6 show the proportion of fixations to *target* vs. *alternative* in the AL and AE conditions. For each frame (recorded on the *x*-axis), looks to target vs. alternative (recorded on the *y*-axis) are calculated as follows. Taking the sentence in (4) as paradigm, target looks is the average amount of looks to the two cells containing locks in the two “relevant” rows of the display divided by the total number of looks to the screen in that frame, and alternative looks is the average amount of looks to the two “other” cells in the relevant rows divided by the same number. A frame was coded as containing a look to a cell if either the participant was fixating the cell or the eye was in transit to that cell during a saccadic eye movement. The vertical bars on the graphs mark the frames corresponding on average to the beginning of the conjunction, the noun in the second conjunct, the verb in the VP, the noun in the object NP, the 300msec pause, and the follow-up instruction in the auditory stimuli.

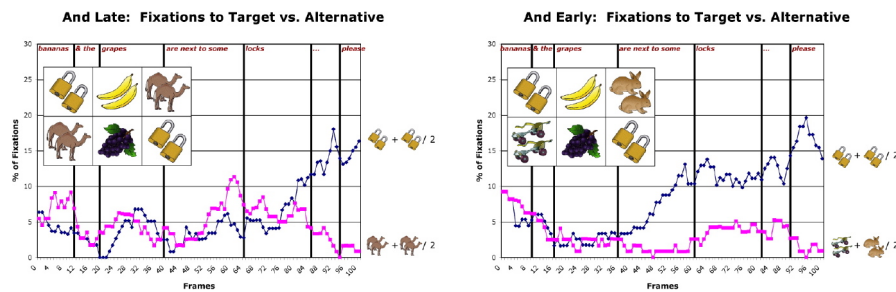

Figure 6: Fixation timelines (and)

Visual inspection of the graphs reveals that, as expected, participants converged on fixating the target much earlier in the AE condition than in the AL condition. In AL looks to target vs. alternative diverge only after the beginning of the object noun, but the two diverge already after the second conjunct in the AE condition.

To more closely investigate disambiguation, we divided each auditory stimulus into time windows, corresponding to the regions delimited by vertical bars in the above graphs. The length of these windows varies on a per-item basis due to differences in the duration of the recorded stimuli. The start and end point of each window were offset 200ms (6 frames) to account for the approximate amount of time needed to plan and launch a saccade based on incoming auditory information.⁴ For the first four regions following the conjunction—corresponding to (i) the noun in the second conjunct, (ii) the VP minus the object noun, and (iii) the object noun in the first sentence, and (iv) the pause between the first sentence and the follow-

up instruction—we conducted an omnibus ANOVA with subjects as a repeated measure. Event (2nd Coord NP, Verb, Object NP, Pause), Condition type (Late, Early), and Object fixated (Target, Alternative) were within-subjects factors. The dependent measure was the average proportion of fixations in each window.

The ANOVA reveals a significant Event \times Condition \times Object interaction ($F(3, 45)=3.64, p=0.0196$). Planned comparisons show that the effect is due to differences between the AL and AE conditions in the participants' preference for fixating the target vs. alternative objects. In AL participants do not display a preference for the target until the pause between the first sentence and the follow-up instruction. On the other hand, in AE participants prefer to fixate the target already while they hear the verb of the first sentence ($F(1,45)=16.26, p=0.0002$). Figure 7 shows the difference between the mean fixation to target and the mean fixation to alternative in the AL and AE conditions for the four time windows; values for which this difference is statistically significant are circled.

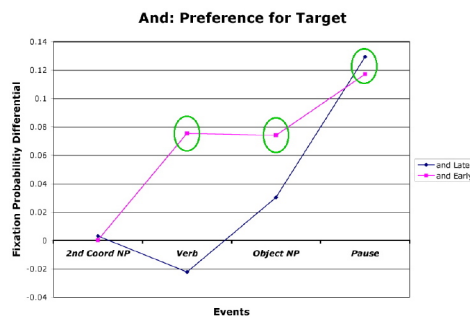

Figure 7: Preference for target (and)

3.2.2 Discussion

The results suggest that participants in this study were able to access and integrate the lexical meaning of *and* very locally to the utterance of the conjunction and use this information to guide the further processing of the sentence. In particular, disambiguation of the target occurs immediately after hearing the second conjunct in the AE condition. As soon as the two relevant rows are identified, participants can use the information provided by the conjunction to uniquely identify the target, well before the target itself is explicitly mentioned in the auditory stimulus.⁵

This shows that the experimental methodology adopted in this study is appropriate to the task. Within the design of the experiment, the behavioral measure provided by the visual-world paradigm can detect local effects of the integration of lexical semantic information. We can thus turn to testing our experimental hypothesis: the implicated content of *or*—i.e. its exhaustive interpretation—should trigger similar local disambiguation effects.

3.3 The case of or

3.3.1 Results

The graphs in Figure 8 show the proportion of fixations to target vs. alternative in the OL and OE conditions. The way of computing looks to target and alternative is a little different in this case. Consider the OE condition first, assuming that subjects hear (6) as auditory stimulus. Under our experimental hypothesis we expect subjects to look away from the two pairs of roller skates, which thus constitute the alternative. But what about the target? Taking the other two cells in the two relevant rows as target would be appropriate only until the word *locks* begins to be played: after that, we expect subjects to concentrate on the locks alone. Thus, for the OE condition we decided to compare the proportion of looks to the single cell containing the intended target to the average proportion of looks to the two cells containing identical objects. Items in the OL condition were constructed so that for each item in the OE condition a corresponding item existed that contained the intended target in the same cell, but replaced the two identical alternative objects with two different objects. Looks to alternative in the OL condition were calculated by averaging looks to the two cells containing these different objects.⁶

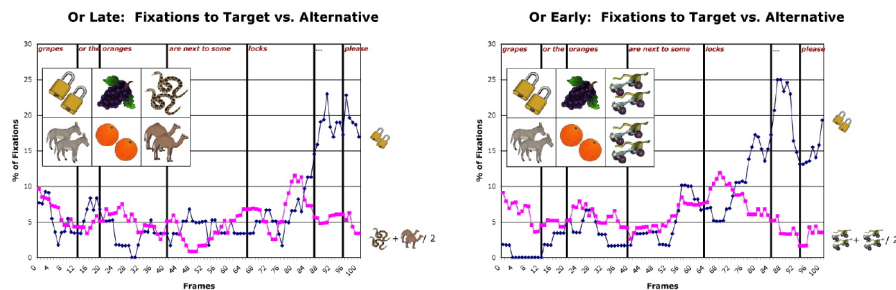

Figure 8: Fixation timelines (or)

Visual inspection of the graphs reveals that participants converged on fixating the target earlier in the OE condition than in the OL condition. In OL looks to target vs. alternative clearly diverge only after the end of the first sentence; in OE the two diverge while the object noun is being heard. The expected effect is thus found, but this effect seems to be delayed with respect to that found in the case of *and*.

In order to better understand the results, we conducted an omnibus ANOVA with subjects as a repeated measure on the first four time windows following the disjunction, corresponding to (i) the noun in the second disjunct, (ii) the VP minus the object noun, and (iii) the object noun in the first sentence, and (iv) the pause between the first sentence and the follow-up instruction. Event (2nd Coord NP, Verb, Object NP, Pause), Condition type (Late, Early, Inclusive), and Object fixated (Target, Alternative) were within-subjects factors. The dependent measure

was the average proportion of fixations in each window.

In this case, the ANOVA does not reveal a significant Event \times Condition \times Object interaction. However, planned comparisons show that the OE condition differs from the OL and OI conditions with respect to the participants' preference for fixating the target. In OL and OI participants do not display a preference for the target until the pause between the first sentence and the follow-up instruction. On the other hand, in OE participants prefer to fixate the target already while they hear the object noun in the VP of the first sentence ($F(1,90)=10.713$, $p=0.0015$). Figure 9 shows the difference between the mean fixation to target and the mean fixation to alternative in the OL, OE, and OI conditions for the four time windows; values for which this difference is statistically significant are circled.

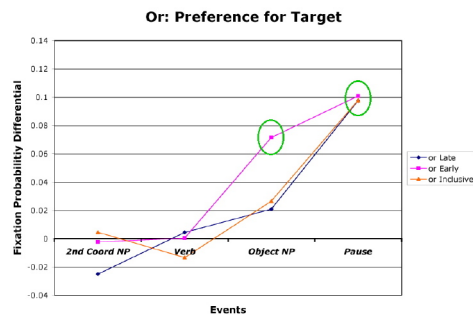

Figure 9: Preference for target (or)

3.3.2 Discussion

The early POD effect found in the OE condition suggests that participants were able to locally use the exclusive meaning of *or* to guide the further processing of the sentence and restrict the set of possible targets. Notice that while disambiguation of the target occurs in OE in the time window corresponding to the object noun (e.g. locks), the effect cannot be due to the explicit mention of the target. As shown by the results for the AL, OL and OI conditions, effects of the integration of the lexical meaning of the object noun can be detected only in the time window corresponding to the pause after the first sentence.

This argues that the exclusive interpretation of *or* is available at an early stage in the processing of the first sentence. Were subjects to initially interpret *or* as the logical disjunction \vee , differences in their behavior in OE vs. OL and OI would not be expected until after the integration of the meaning of the object noun.

4. General Discussion

Two main results follow from our experiment. The first result is that the methodology that we devised seems to allow for investigating the meaning of words like *and* or *or* without setting up an explicit verification task. Data collected using this methodology are less likely to confound effects of the integration of the meaning of these expressions with those due to strategies adopted by the participants.

The second result is that we find evidence that the exclusive component of the meaning of *or* is integrated (and thus calculated) online. Our experimental analysis was led by the hypothesis that the exclusive component of the interpretation that is normally associated with sentences containing the disjunction *or* is calculated very locally to the utterance of this lexical item. It appears that *or* is given an exclusive interpretation already before the sentence containing the disjunction has been processed in its entirety, which clearly undermines the “extreme” alternative to our experimental hypothesis that many authors seem to have attributed to Grice. The exclusive interpretation of *or* seems to be available to participants at a point where the “literal meaning” of the sentence containing the disjunction cannot be calculated because the sentence has not been heard in its entirety.

At the same time, the most extreme version of our locality hypothesis does not seem to be upheld by the results either. Participants in our experiment do not seem to use the information provided by the exclusive meaning of *or* as early as they use the information provided by the lexical semantics of *and*. The early POD effect attested in the OE condition occurs later, and is thus less local than the one found in the AE condition.⁷ This provides a potential argument against the hypothesis that the exclusive component of the meaning of *or* becomes available as soon as the disjunction is heard. For the purpose of this paper, we would like to hold on drawing the latter conclusion. Our reluctance in abandoning the strong version of our experimental hypothesis is motivated by the observation that the asymmetry found between the effects in the case of *and* vs. *or* might be due to independent issues arising from specific properties of our experiment.

One potential problem follows from our choice of investigating the $\langle \text{and}, \text{or} \rangle$ scale in the first place. An independent formal asymmetry holds between the two elements in this scale: while a conjunction of NPs can denote both in e and $\langle et, t \rangle$, a disjunction of NPs is inherently non-referential. This asymmetry might be playing an unwanted role in our experiment because the experimental task in the visual-world paradigm is essentially a referential one: subjects are implicitly asked to determine an interpretation for the auditory stimulus with respect to the referential domain provided by the visual display. It is thus possible that the delayed effect found in the OE condition indicates a delayed integration of the whole meaning of *or*, and not just of its exclusive component. That is, *or* could be interpreted as exhaustive as soon as it is heard, but its meaning be of a type that—unlike the meaning of *and*—cannot be used right away in the visual-world setting.

A second problem is that we unwillingly introduced a strong bias in the exper-

imental materials that militates against the effects that we expected to find in the OE and OI conditions. Consider again the visual display in Figure 4. A subject faced with a display of this type who always chose to concentrate on the cells containing the three identical objects would be 75% correct in guessing the identity of the target, without paying any attention to the nature of the coordination in the subject of the first sentence. Such a strong bias is likely to have been unconsciously picked up by participants, with the result of undermining both the early POD effect in OE and the expected disambiguation delay in OI.

In ongoing follow-up work we address these confounds, improving the experimental design and extending the scope of investigation to the ⟨all,some⟩ scale, where an asymmetry similar to that occurring in the case of ⟨and,or⟩ does not arise.

5. Conclusions

Our experiment provides initial evidence that the exclusive meaning of or is integrated locally to the utterance of the disjunction, and can guide the further processing of the sentence containing it. Like other types of linguistic information, scalar implicatures seem to be computed and integrated online, as part of the incremental processing of a sentence.

As a parting note, we want to explicitly state that we do not intend to draw conclusions bearing directly on the current theoretical debate on the nature of scalar implicatures from the provisional results of our experimental investigation. Like Grice, most contenders in the theoretical arena aim at an appropriate rational reconstruction of the logic underlying the derivation of implicatures and of the types of information involved in it, and do not commit to hypotheses concerning the use of this knowledge that can be straightforwardly translated into behavioral predictions. Still, we think that these and further experimental results can contribute to the debate by defining empirical requirements that a psychologically realistic analysis of scalar implicatures should be able to meet at no additional cost.

Endnotes

* We want to thank Ivano Caponigro, Greg Carlson, Christine Gunlogson, Carson Schütze, and Rachel Sussman for their input and comments on the design and results of this experimental work. Cassie Filios and Rebekka Puderbaugh helped us in testing subjects and coding data. Further useful input was provided by audiences at WECOL 2004, Sinn und Bedeutung IX, the UCLA Psychobabble seminar, a University of Maryland CNL Lab Lunch Talk, and the Tanenhaus Lab meetings in Rochester. This work was partially supported by NIH grant T32 DC35-09 and by NIH grant HD-27206. Any remaining shortcomings in the form or content of this paper should be blamed on the first author.

A slightly different version of this paper appears in the Proceedings of Sinn und Bedeutung IX.

¹ As pointed out by Carson Schütze (p.c.), the instruction in (b) is potentially confusing in the case of sentences containing a conjunction in subject position as in (7). The instruction could be interpreted as requiring to click on the two pairs of locks in the top two rows or on just one of these pairs. Both types of actions were considered as correct in analyzing the data. This source of confusion is removed in the follow-up experiments that we are currently running, as are the problems raised by the possibility of

interpreting the indefinite in object position as scoping over the subject in the first sentence.

² One note about terminology. Since in our analysis we consider only looks to the two rows referred to by the subject of the first sentence, from now on we will use the term ‘intended targets’ to refer only to objects of the type mentioned in the VP that appear in these rows.

³ Fixation data from 6 additional participants were not analyzed: <90% correctness in performing the requested action was taken to indicate that participants were not attending to the experimental task.

⁴ E.g. to ensure that auditory information about the object noun can influence eye movements in the corresponding window, the start point for this window needs to be 6 frames after the onset of locks.

⁵ When we presented our results, people in the audience voiced the concern that the early POD effect found in the AE condition might be due to properties of the visual stimuli. In AE subjects might prefer looking towards the two “alike” objects rather than towards the two “different” ones. This account for the effect found in AE fails in light of the findings for the OE condition, which is visually indistinguishable from AE but does not seem to induce a comparable preference for the two alike objects.

⁶ Looks to target vs. alternative in the OI condition were calculated exactly as in the AE condition.

⁷ Furthermore, we do not find the related expected further disambiguation delay in the OI condition.

References

- Bach, Kent. to appear. “The top 10 misconceptions about implicature”. In Betty Birner and Gregory Ward (eds.), *Drawing the Boundaries of Meaning: Neo-Gricean Studies in Pragmatics and Semantics in Honor of Laurence R. Horn*. Amsterdam: John Benjamins.
- Bott, Lewis and Ira A. Noveck. 2004. “Some utterances are underinformative: The onset and time course of scalar inferences”, *Journal of Memory and Language*, **51**.3:437–457.
- Breheny, Richard and Napoleon Katsos. 2003. “Are generalised conversational implicatures generated on-line by default?” Paper presented at the *Workshop on Polarity, Scalar Phenomena, and Implicatures*, University of Milan, Bicocca.
- Chierchia, Gennaro, Charles Clifton, Jr., and Lyn Frazier. 2003. “When basic meanings are (not) enough: Processing scalar implicatures during adult language comprehension”. Manuscript, University of Milan, Bicocca and University of Massachusetts, Amherst.
- Cohen, Jonathan D., Brian MacWhinney, Matthew Flatt, and Jefferson Provost. 1993. “PsyScope: A new graphic interactive environment for designing psychology experiments”, *Behavioral Research Methods, Instruments, and Computers*, **25**.2:257–271.
- Eberhard, Kathleen M., Michael J. Spivey-Knowlton, Julie C. Sedivy, and Michael K. Tanenhaus. 1995. “Eye movements as a window into real-time spoken language comprehension in natural contexts”, *Journal of Psycholinguistic Research*, **24**:409–436.
- Horn, Larry. 1972. “On the semantic properties of logical operators in English”. Ph.D. thesis, University of California, Los Angeles.
- Matin, E., K. Shao, and K. Boff. 1993. “Saccadic overhead: Information processing time with and without saccades”, *Perception & Psychophysics*, **53**:372–380.
- Noveck, Ira A. and Andres Posada. 2003. “Characterizing the time course of an implicature: An evoked potential study”, *Brain and Language*, **85**:203–210.
- Rossion, Bruno and Gilles Pourtois. 2004. “Revisiting Snodgrass and Vanderwart’s object pictorial set: The role of surface detail in basic-level object recognition”, *Perception*, **33**.2:217–236.
- Tanenhaus, Michael K., Michael J. Spivey-Knowlton, Kathleen M. Eberhard, and Julie C. Sedivy. 1995. “Integration of visual and linguistic information in spoken language comprehension”, *Science*, **268**:1632–1634.

Two Types of Relative Clauses in Slavic – Evidence from Reconstruction and Ellipsis

Adam Szczegielniak
Harvard University

1. Introduction¹

This paper argues that there must be two ways to derive relative clauses in Polish and Russian. The type of derivation strongly correlates to the type of relative marker used in these constructions. Polish and Russian has two main relative markers: *co/čto* and *który/kotoryi*.

1. a. Marysia zna chłopców, **których** Ania lubi
Mary knows boys who Ann likes
'Mary knows some boys who Ann likes'
- b. Marysia zna chłopców, **co** Ania lubi
Mary knows boys that Ann likes
'Mary knows some boys that Ann likes'
2. a. Maša znajet mal'čikov, **kotoryx** Anna ljubit
Mary knows boys who Ann loves
'Mary knows some boys who Ann loves'
- b. Maša znajet mal'čikov, **čto** Anna ljubit
Mary knows boys that Ann loves
'Mary knows some boys who Ann loves'

Polish permits both markers to be present, but Russian does not:²

3. a. Marysia zna chłopców, **co którzy** Ania lubi
Mary knows boys that who Ann likes
'Mary knows some boys who Ann likes'

- *b. Maša znajet mal'čikov, **čto kotoryx** Anna ljubit
 Mary knows boys that who Ann loves
 'Mary knows some boys who Ann loves'

I propose that the following correlation holds between the type of relative marker and the type derivation of a relative clause:

4. a. *Co/čto* relative clauses are generated via head noun movement (Raising analysis, Sauerland 1998). There are no null operators.

Raising analysis (Sauerland 1998)

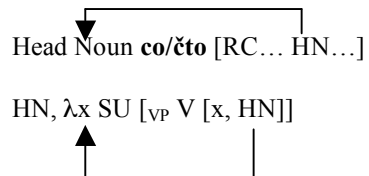

- b. *Który/kotoryi* relative clauses, which include polish *co+który* relatives, are generated via operator movement to Spec-Topic in the Left Periphery (Rizzi, 1997) and adjunction to the head noun. *Który/kotoryi* is the operator (marked for case/number/person/gender). (Matching analysis, Sauerland 1998).

Matching analysis, (Sauerland 1998).

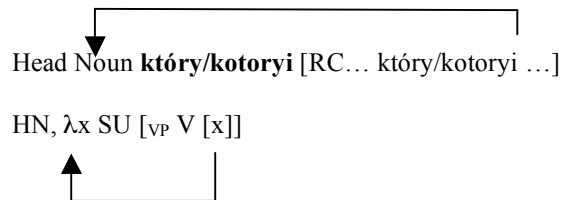

In the next sections I will provide support for the hypothesis in (4). First I will examine evidence that the head noun in *co/čto* relative clauses can reconstruct to a position inside the relative clause, whereas the head noun in *który/kotoryi* relative clauses cannot. Later, I provide support that in that the head noun in *co/čto* relative clauses not only can but **must** reconstruct to a position inside the relative clause. For reasons of space, I will omit Russian examples (for a full set

of data see Szczegielniak 2005a) when Polish and Russian judgments pan out in the same way.

2. Optional Head Noun Reconstruction

It has been argued that degree/amount readings are possible with relative clauses that are derived via head noun raising (Carlson 1977) and others. Consider the following example:

5. It will take us the rest of our long lives to drink the champagne that/Ø/*which they spilled that evening

There are various proposals as to how to derive degree/amount readings (see Grosu and Landman 1998). Most share the idea that the degree/amount part of the head noun must be interpretable inside the relative clause, which in the majority of analyses implies that part of the head noun can reconstruct. This is what I will assume, namely that the ability to reconstruct the degree/amount semantics of the head noun is a prerequisite for having a degree/amount reading. Consider the following contrasts in Polish (I mark as ungrammatical the lack of a degree/amount reading):

6. ??a. Całe życie nam zajmie wypić ten szampan, **który**
 whole life us take drink this champagne which
 oni rozlali dziś
 they spilled today
 ‘It will take us our whole life to drink all the champagne that the spilled today’
- b. Całe życie nam zajmie wypić ten szampan, **co** oni rozlali dziś
 whole life us take drink this champagne that they spilled today
 ‘It will take us our whole life to drink all the champagne that the spilled today’
- ??c. Całe życie nam zajmie wypić ten szampan, **co który**
 whole life us take drink this champagne that which
 oni rozlali dziś
 they spilled today
 ‘It will take us our whole life to drink all the champagne that the spilled today’

As we can see degree/amount readings are only possible with *co/čto* relative clauses. It is interesting to not that *co/čto* relatives lose this ability to license amount/degree readings when the relative contains a resumptive pronoun:

7. ??a. Całe życie nam zajmie wypić ten szampan, **co**
 whole life us take drink this champagne that
 ja wiem że **go** oni rozlali dziś
 I know that it they spilled today
 'It will take us our whole life to drink all the champagne that I
 know that they spilled today'

The fact that resumptive block a degree/amount reading allows me to assume that movement of the head noun is necessary in order to have the possibility of a degree/amount reading. Note that pronouns can carry a degree/amount reading, just consider examples like those below:

8. Jurek kupił masę szampana.
 John bought mass champagne.
 'John bought a lot of champagne'

Tyle, że cały rok by nam zajęło go wypić.
 Much that whole year would us take it drink
 'So much that it would take us a whole year to drink it'

This shows that the inability to have a degree/amount reading in (7) is not because a pronoun cannot carry such a reading, but must be due to some other factors.³ The ability to have a degree/amount reading shows that *co/ćto* relatives permit head noun reconstruction, whereas *który/kotoryi* relative clauses do not.

Carlson (1977) noticed that the same determiners that restrict degree readings also restrict idiom split-up:

9. a. The/all/that/what headway that John made was
 impressive
 *b. Some/much/most/little/this headway that John made was
 impressive.
10. It will take us the rest of our long lives to drink the/*much champagne
 that they spilled that evening

In Polish and Russian, as well as in English, idioms can be split up only with one set of relative markers. Consider the following examples:

11. The headway *which/that John made was enormous

- 12 a. Słów **co** on nie rzucał na wiatr
words that he not throw on wind
'Empty promises that he did not make'
- ??b. Słów **których** on nie rzucał na wiatr
words which he not throw on wind
'Empty promises that he did not make'
- ??c. Słów **co których** on nie rzucał na wiatr
words that which he not throw on wind
'Empty promises that he did not make'

Not surprisingly these are the same markers that permit degree/amount readings. I will argue that the ability to have reconstruction of the head noun is a prerequisite for relativizing an idiom. Hence only *co/čto* relatives can split up idiom chunks.

Note that as in the case of degree/amount readings, having a resumptive pronoun in the relative clause blocks idiom relativization. Consider the following examples:

13. ??a. Słów **co** on **je** nie rzucał na wiatr
words that them he not throw on wind
'Empty promises that he did not make'

Let me now show that *co/čto* relatives require head noun reconstruction. Evidence supporting this claim comes from contrasts in the ability to license appositive versus restrictive readings, the ability to overcome Condition – C effects.

3. Forced Head Noun Reconstruction

Appositive relative clauses have been analyzed as being separate clauses from the head noun (see: Chierchia & McConnell-Ginet 1999). This predicts that relative clauses where head noun reconstruction is obligatory should not allow appositive readings, whereas relative clauses where head noun reconstruction is prohibited should allow such a reading. This is exactly the pattern we obtain for Polish and Russian. Consider the following examples of relativizing proper names (in order to force an appositive reading) in Polish and Russian:

14. *a. Maria, **co** Marek pocałował poszła do domu
Mary that Mark kissed went to home
'Mary, who Mark kissed, went home'

- b. Maria, **którá** Marek pocałował poszła do domu
 Mary who Mark kissed went to home
 ‘Mary, who Mark kissed, went home’
- b. Maria, **co którá** Marek pocałował poszła do domu
 Mary that who Mark kissed went to home
 ‘Mary, who Mark kissed, went home’

The above contrasts support the claim that *co/čto* relative clauses *must* be generated via head noun movement and that is why an appositive reading is impossible with these relatives (see also Aoun & Li 2003 for similar claims for English). Note that, as in previous cases, a resumptive pronoun changes the contrast. Thus resumptives allow appositive readings in *co/čto* relative clauses:

15. Maria, **co ją** Marek pocałował poszła do domu
 Mary that her Mark kissed went to home
 ‘Mary, who Mark kissed, went home’

Another prediction of the hypothesis in (4) is that in *co/čto* relative clauses there should be no possibility of ‘escaping’ Condition – C effects resulting from the reconstruction of the head noun into a position C-Commanded by the co-indexed pronoun. Consider the following examples:

16. *a. [Którá koleżankę Janka_i]₁ Maria chce by on_i poznał t₁
 Which friend John’s_i Mary wants that he_i meet
 ‘Which friend of John’s Mary wants him to meet?’

As we can see, wh-movement involves reconstruction, which in turn causes a Condition-C violation. In the case of relativization, head noun reconstruction is obligatory in *co/čto* relative clauses - hence there is no possibility to escape Condition-C effects. There is no head noun reconstruction in *który/kotoryi* relative clauses – in these constructions we observe the head noun ‘escaping’ Condition-C effects.⁴

17. ??a. Znam koleżankę Janka₁ **co** on₁ powiedział że chce
 Know friend(fem) John₁ that he₁ said that wants
 polubić
 like
 ‘I know a friend of John that he said that he wants to like’

- ³b. Znam koleżankę *Janka*₁ **którą** *on*₁ powiedział że chce
 Know friend(fem) John₁ who he₁ said that wants
 polubić
 like
 'I know a friend of John that he said that he wants to like'
- ²c. Znam koleżankę *Janka*₁ **co którą** *on*₁ powiedział że chce
 Know friend(fem) John₁ that who he₁ said that wants
 polubić
 like
 'I know a friend of John that he said that he wants to like'

The listed contrasts between *co/ćto* relative clauses and *który/kotoryi* relative clauses support the hypothesis in (4). *Który/kotoryi* relatives are generated via operator movement and relative clause adjunction to the head noun, whereas *co/ćto* relatives are generated via head noun raising from within the relative clause. The lack of head noun reconstruction in the former and forced reconstruction in the latter (due to a lack of null operators) gives us the pattern of results discussed above.

In the next section, I will discuss an interesting interaction between VP ellipsis and relative clause formation. It will be shown that VP ellipsis that is licensed by VP topicalization is only possible in *co/ćto* relative clauses. I will argue that this is because in *który/kotoryi* relatives operator movement and VP topicalization interact to cause a violation on Remnant Movement. This discussion is aimed to show two things: (i) operator movement is only present in *który/kotoryi* relatives, (ii) operator movement is a form of topicalization (see Bianchi 1999).

4. VP Ellipsis in Relative Clauses

Unlike English, Polish and Russian allow so-called bare VP-ellipsis (see Szczegielniak 2005a) where only the subject remains inside the relative clause:

18. a. Jan czyta książkę w domu a Maria **e** w bibliotece
 Jan reads book in home but Mary in library
 'Jan is reading a book at home but Mary is in the library'

However, when we try bare-VP ellipsis in relative clauses an interesting contrast shows up:

19. a. Ja przeczytałem każdą książkę **co** ty
 I read every book that you
 'I read every book that you did'

- *b. Ja przeczytałem każdą książkę **którą** ty
 I read every book that you
 'I read every book that you did'

Bare VP ellipsis is only possible in *co/ěto* relatives. This I will argue is because bare VP ellipsis requires VP topicalization. In Szczegielniak (2005a) I discuss extensively support for this claim. For reasons of space, let me examine just one piece of evidence. Polish has past tense auxiliary past tense clitics (see: Szczegielniak 2005b, Borsley and Rivero 1994) that have this interesting property of not being able to be hosted by an XP that is linearly preceded by the verb. Consider the following examples:

20. a. Tyś poszedł do kina
 you+CL went to cinema
 'You went to a cinema'
- *b. [Poszedł do kina]₁ tyś t₁
 went to cinema you+CL
 'You went to the cinema'
- c. [Poszedłeś do kina]₁ ty t₁
 went+CL to cinema you
 'You went to the cinema'

Bare-VP ellipsis is possible when the clitic is hosted by material that is sufficiently high up in the clause (Spec-Force following Rizzi 1997):

21. a. Ja dałem książkę wysokiej dziewczynie, a jakiejście
 I gave book tall girl and which+CL
 wy?
 you?
 'I gave book to a tall girl and to what (type) did you?'
- ??b. Ja dałem książkę wysokiej dziewczynie, a niskiej
 I gave book tall girl and short
 dziewczynieście wy
 girl+CL you
 'I gave book to a tall girl and you did to a short girl'

The above examples show that the clitic can be hosted by a *wh*-word, but not by a topicalized element when bare VP ellipsis has taken place. In Szczegielniak (2005a) I argue that this is because ellipsis is licensed by VP Topicalization. Example (21b) is bad for the same reason as (20b). If we assume that operator

movement is movement to a Topic head in the Left Periphery (Bianchi 1999), we can account for the contrast between (19a) and (19b). Operator movement leaves a trace in the VP, which then has to raise above the operator. Since both movements involve raising to a Topic head, we have a violation on Remnant Movement (Müller 1998).

- *22. Ja przeczytałem każdą książkę **którą** ty
 I read every book that you
 'I read every book that you did'

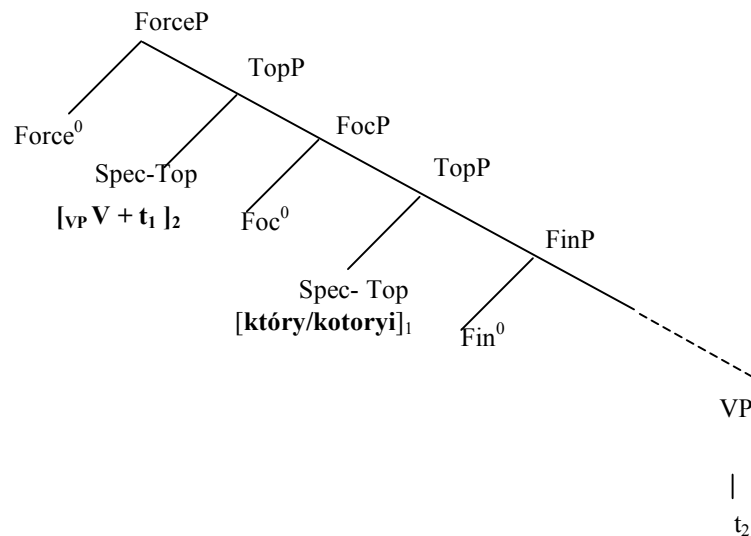

Example (22) violates remnant movement condition, as stated below:

23. Remnant movement condition (informal)
 A constituent α cannot raise above β if α contains a copy of β , and α and β have undergone the same type of movement.

$$*[\chi [\alpha_P \dots \alpha \dots t_1]_2 \dots [\beta]_1 \dots \lambda P \dots [t_2]]$$

We can see the condition in operation in Polish:

24. a. Ja wiem że [o Reaganiu]₁ ty kupiłeś [nową książkę t₁]
 I know that about Reagan you bought new book
 'I know that you bought a new book about Reagan'
- ??b. [Nową książkę t₁]₂ ja wiem że [o Reaganiu]₁ ty kupiłeś t₂
 New book I know that about Reagan you bought
 'I know that you bought a new book about Reagan'
- c. [Nową książkę o Reaganiu]₁ ja wiem że ty kupiłeś t₁
 New book about Reagan I know that you bought
 'I know that you bought a new book about Reagan'

Bare VP ellipsis is possible in *co/ćto* relative clauses since there is no operator movement to the Topic head. Instead in cases of bare VP ellipsis the head noun raises with the topicalized VP and then undergoes further movement.

Note that this account predicts that in cases when VP topicalization does not contain the trace of the operator, bare VP ellipsis should be possible in *który/kotoryi* relative clauses. This is exactly the case in relative clauses where the operator is an adjunct. Consider the following example:

25. a. Ja zagram w każdym barze **w którym** ty
 I play in every bar in which you
 'I will play in every bar in which you will'

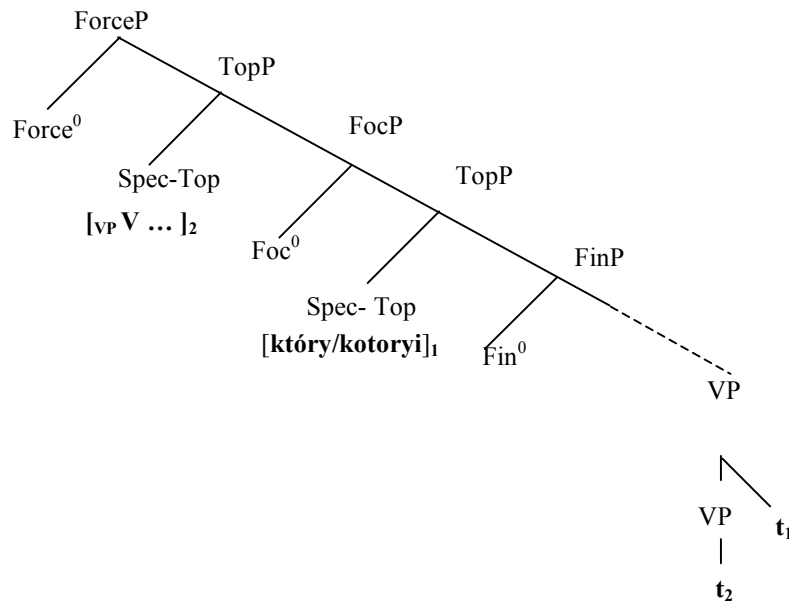

In such cases there is a smaller VP that can undergo topicalization and it does not contain the trace/copy of the operator.

In this section I have shown that *który/kotoryi* operator movement is movement to Topic since it interacts with VP topicalization. I have also provided further support for the hypothesis in (4).

This paper has provided arguments from reconstruction and the interaction of ellipsis and operator movement that there are two distinct ways to form relative clauses in Polish and Russian.

Notes

¹ I would like to thank Noam Chomsky, David Pesetsky, Hagit Borer, Ray Jackendoff, Heidi Harley and Agnieszka Lazorzcyk, as well as the WECOL' 05 participants for their comments.

² These constructions are not restricted to any particular dialect or register.

³ For reasons of space I will not discuss why a resumption relationship does not allow for a degree/amount reading. What is crucial for this discussion is the fact that resumption blocks reconstruction and that blocks a degree/amount reading.

⁴ There are speakers of Polish and Russian who do not get these contrasts. I have no account of this variation.

References

- Aoun, Joseph, and Audrey, Li Yen-hui. 2003. *Essays on the Representational and Derivational Nature of Grammar: the Diversity of Wh-constructions*: Linguistic Inquiry Monographs 40. Cambridge, Mass.: MIT Press.
- Bianchi, Valentina. 1999. *Consequences of Antisymmetry*: Studies in Generative Grammar: Mouton De Gruyter.
- Borsley, Robert D. and María Luisa Rivero. 1994. "Clitic Auxiliaries and Incorporation in Polish", *Natural Language and Linguistic Theory*, **12**. 3:373-422.
- Chierchia, Gennaro and Sally, McConnell-Ginet. 1990. *Meaning and Grammar*. Cambridge, MIT: MIT Press.
- Carlson, Greg. 1977. "Amount Relatives", *Language*, **53**. 3:520-542.
- Grosu, Alexander, and Fred, Landman. 1998. "Strange Relatives of the Third Kind", *Natural Language Semantics*, **6**. 2:125-170.
- Müller, Gereon. 1998. *Incomplete Category Fronting: a Derivational Approach to Remnant Movement in German*. Studies in Natural Language and Linguistic Theory; vol. 42. Dordrecht, Boston: Kluwer Academic.
- Rizzi, Luigi. 1997. "The Fine Structure of the Left Periphery", *Elements of Grammar*. Liliane Haegeman (ed): 281-337. Dordrecht: Kluwer.
- Sauerland, Ulrich. 1998. "On the Making and Meaning of Chains", MIT Doctoral Dissertation. Distributed by MITWPiL.
- Szczegielniak, Adam. 2005a "Relativization that you did...", Harvard Doctoral Dissertation. Distributed by MITWPiL.
- Szczegielniak, Adam. 2005b. "Clitic Positions within the Left Periphery: Evidence for a Phonological Buffer", *Clitic and Affix Combinations*. Heggie, Lorie and Francisco Ordoñez (eds.). Benjamins: 283–299.

*Adam Szczegielniak
Department of Linguistics
Harvard University
Boylston Hall
Cambridge, MA 02138
szczeg@fas.harvard.edu
absynt@gmail.com*

Manipulation of Verbal Inflection in English and Spanish Spontaneous Speech Errors*

Ellen Thompson

Florida International University

1. Introduction

Linguists have pursued the scientific study of slips of the tongue since at least as far back as the eighth century (Anwar 1979, 1981, Cutler 1982a). In recent years, the analysis of spontaneous speech errors has become a central research method in the investigation of language production (Fromkin 1971, Garrett 1975, Dell 1986, Levelt 1989).

Generative linguists have researched spontaneous speech errors¹ in order to discover the underlying processes of the linguistic system, assuming that “the rules of grammar enter into the processing mechanisms”, that “evidence concerning production, recognition, recall, and language use in general can ... have bearing on the investigation of rules of grammar, on... ‘grammatical competence’ or ‘knowledge of language’” (Chomsky 1980: 200-201).

Contemporary research on speech errors has argued that spontaneous speech error data can help us decide between competing approaches to linguistic phenomena (Roberts 1975, Becker 1979, Fay 1980b, Stemberger 1984, Berg 1987). I follow in this tradition here, by examining the cross-linguistic behavior of spontaneous speech errors involving verbal inflection. I argue that the pattern of errors observed in main versus auxiliary verbs in English supports the hybrid theory of inflection of Lasnik (1995), according to which main verbs are derivationally constructed out of syntactically separate stem and affix, while (inflected) auxiliary verbs form a single lexical unit (see Chomsky 1957). This view is in contrast to the standard Minimalist analysis of inflectional morphology, according to which both main and auxiliary verbs come from the lexicon fully inflected (Chomsky 1995). I show that the present analysis of English speech errors receives support from the different pattern of errors in Spanish, a language which I claim to exhibit a uniform system of inflectional morphology.

The paper is organized as follows. In section two, I discuss the generative study of syntactic slips of the tongue. Section three introduces data from English showing that main verbs undergo errors in which inflection and

stem are separated, such as reversals, deletion, and movement errors (henceforth, separation errors). Auxiliary verbs do not undergo these types of errors. I argue that this observation is explained by the claim that main verbs in English are separated into stem and affix, while auxiliary verbs are a single unit structurally, in section four. This theory is supported by spontaneous speech error data involving main verb *be* versus main verb *have*.

In section five, I consider the hypothesis that the different distribution of speech errors in main and auxiliary verbs is due to their relative frequency of usage. I argue against this view by showing that English auxiliary verbs do in fact undergo a variety of structural speech errors, and only do not exhibit separation errors. I next turn in section six to a discussion of the facts from Spanish, showing that auxiliary as well as main verbs exhibit separation errors. I argue that Spanish auxiliary (and main) verbs are derived as are English main verbs, constructed from a rule joining together stem and affix, in section seven. I conclude the paper in section eight with a discussion of the predictions for cross-linguistic speech error patterns that the current theory makes.

2. Some data

A fundamental observation about occurring spontaneous speech errors is that they are constrained to those errors which are stable in terms of the linguistic system (Fromkin 1971, 1973, 1980, 1988, Cutler 1982). As Fromkin (1988:121) notes, "...spontaneously produced speech errors reveal deviations in the units and rules" of language.

Within the generative study of syntactic speech errors, researchers have argued that certain errors provide evidence for movement transformations in the grammar (Fay 1980a, 1980b). The error in (1) can be characterized as the lack of application of the obligatory WH-movement process, and the error in (2) can be understood as an instance of overapplication of particle movement. (The intended utterance appears to the left and the spoken utterance to the right of the arrow). Notice that errors such as (3), with random reordering of words, are unattested. (The English errors discussed in this paper are from the UCLA Speech Error Corpus, online at <http://www.mpi.nl/world/corpus/sedb/>, unless otherwise indicated.)

- (1) Linda, which ear do you talk on the telephone with? ->
Linda, do you talk on the telephone with which ear?
- (2) His secretary types it up -> His secretary types up it
- (3) *Who did Frances invite to the party? ->
Party Frances invite the to did who?

3. Main and auxiliary verbs in speech errors

In this section, I discuss slips of the tongue involving main and auxiliary verbs in English, showing that main verbs participate in a pattern of speech errors that auxiliary verbs do not.

3.1 Overregularization

Irregular main verbs appear in speech errors as regular forms, as illustrated in (4). However, we do not observe similar errors with auxiliary verbs.

- (4) a. the last I knew about that -> the last I knowed about that
 b. and the objects that would be locally bound ->
 and the objects that would be locally binded

3.2 Reversal errors

As is seen in the examples in (5), main verbs may switch position, in which case inflectional material may be stranded, with each verb surfacing with the inflection of the other verb.

- (5) a. We've learned to love mountains ->
 We've loved to learn mountains
 b. It goes to show -> It shows to go

It is also possible for the inflectional material itself to switch position between two verbs, as in (6).

- (6) I saw him digging up those bulbs -> I see him dugging up ...

Note that errors with auxiliary verbs appearing in these error patterns are not attested in the data.

3.3 Deletion errors

It is possible to find errors with the main verb deleted, and the inflection of the verb stranding, as in (7).

- (7) As I keep suggesting -> As I keeping

In contrast, when an auxiliary verb is targeted for deletion, the whole unit is affected, as shown in (8).

- (8) He doesn't seem happy now -> He not seem happy now

3.4 Movement errors

Observe that in movement errors the inflectional item itself may move from the verb to another item of the utterance, as in (9a-b). However, these movement errors seem to be restricted to main verbs.

- (9) a. If she wants to come here ... -> If she want to comes here
 b. He kind a tends ta ... -> He kinds a tend ta ...

The data pattern discussed thus far is summarized in (10); in the UCLA Speech Error Corpus, we find thirteen examples of separation errors involving main verbs, but no examples of such errors with auxiliary verbs.

(10) Separation Errors in English

main verb	13
auxiliary verb	0

4. A hybrid theory of inflection (Lasnik 1995)

I propose in this section that we may explain the difference observed between main and auxiliary verbs in speech errors if we adopt the hybrid theory of verbal inflection of Lasnik (1995). In contrast to the standard Minimalist approach to verbal morphology, according to which main and auxiliary verbs come pre-inflected from the lexicon, Lasnik claims that main verbs in English are derivationally constructed out of syntactically separate stem and affix, while (inflected) auxiliary verbs form a single lexical unit (see Chomsky 1957).

For example, the structure of (11a), with the inflected main verb *left*, is as in (11b), where inflection is a separate unit, whereas the structure of (12a), with the inflected auxiliary verb *was*, is as in (12b), where inflection and the verb form a single unit.

- (11) a. Bill left the room
 b. Bill [past] leave the room
 I
- (12) a. Bill was leaving the room
 b. Bill [was] leaving the room
 I

One of the arguments that Lasnik puts forth for this approach to verbal morphology comes from ellipsis constructions. He argues that the analysis accounts for the different behavior of main and auxiliary verbs in non-parallel VP ellipsis constructions. Notice that in (13a), for example, it is not clear how the ellipsis is resolved, if we assume that ellipsis resolution requires identical forms, since the structure in (13b) is not possible. Lasnik claims that (13a) is possible because there is a point in the derivation of the clause where the stem and inflection are separate units, as in the structure in (13c), and therefore the stem alone *sleep* can be interpreted as the ellipsis antecedent. Notice however, as pointed out by Warner (1986), that non-parallel VP ellipsis is not licensed with auxiliary verbs, as is shown by the example in (14a). This is due to the fact that there is no point in the derivation of an auxiliary verb where the verb is separate from inflection, and therefore there is no form *have* which can be accessed to resolve the ellipsis site.

- (13) a. John slept, and Mary will too
 b. *John slept, and Mary will slept too
 c. John [past] sleep, and Mary will ~~sleep~~ too
- (14) a. *John has left, but Mary shouldn't
 b. *John [has] left, but Mary shouldn't ~~has left~~

Adopting this approach, we can explain the speech errors observed in section three. These errors result when the derivation is accessed before the verbal stem and inflection have become a unit, similar to the way in which the examples in (1) and (2) in section two are viewed as a result of accessing the derivation too soon. The stem and/or inflectional item may then undergo transposition, movement, or deletion. We therefore predict that auxiliary verbs do not appear in these error patterns, since there is no point in the derivation of an auxiliary verb at which the verb and inflection are separate units to be manipulated.

4.1 Main verbs *have* and *be*

Lasnik points out that main verb *be* behaves as an auxiliary verb in not licensing non-parallel VP ellipsis, whereas main verb *have* behaves as a main verb, in that it does license non-parallel ellipsis (see Warner 1986, Potsdam 1996 for relevant discussion). The example in (15a) shows that main verb *be* does not license non-parallel ellipsis, thus indicating that the correct structure of this form is as in (15b), with main verb *was* inflected throughout the derivation. As shown by the data in (16a), main verb *have*, on the other hand, behaves as a main verb in licensing non-parallel ellipsis, and thus seems to have the structure in (16b), with inflection a separate unit from the verbal stem.

- (15) a. *John was here, and Mary will too
 b. *John [was] here, and Mary will ~~was here~~ too
- (16) a. Phyllis had a good time, and you will too
 b. Phyllis [past] have a good time, and you will ~~have a good time too~~

Turning to the speech error data, we find confirmation of this approach. Separation errors with main verb *have* are attested, as in (17), however we do not find any errors of this sort with main verb *be*.

- (17) He had to have it -> He haved to have it

5. Frequency effects

A possible alternative explanation for the observed difference in the behavior of main and auxiliary verbs in English is that the contrast is due to a frequency effect. There are two ways to conceive of such an alternative explanation. One is that we do not observe auxiliaries undergoing the errors observed with main verbs because main verbs are more frequent than auxiliaries, and thus it is the relative infrequency of auxiliaries in production data that results in their absence in separation errors. However, this line of reasoning is incorrect, because it has been noted in the literature that in fact, auxiliary verbs are among the highest frequency items in English (Kučera and Francis 1967).

Therefore, an alternative explanation based on frequency is that because auxiliary verbs are high frequency words, being salient in the environment, they are less likely to undergo the types of errors observed for main verbs. In fact, Stemberger (2002) argues that low-frequency verbs are involved more than high-frequency verbs in "overtensing errors" such as in (18), where the past tense of the matrix verb spreads to the embedded nonfinite verb. (Stemberger considers only main verb constructions.)

- (18) I forgot to write -> I forgot to wrote

In the next section, I argue that the lack of separation errors with auxiliaries cannot be due to a frequency effect, since auxiliary verbs do undergo structural errors of various sorts, but only do not undergo errors where the stem and affix are separated. The contrast between main and auxiliary verbs therefore still requires an explanation.

5.1 Auxiliary verbs in speech errors

The data discussed in this section indicates that we do find a variety of structural errors with auxiliary verbs in English. The errors in (19) show that auxiliary verbs undergo errors in the process of question formation (data from Fay 1980).

- (19) a. What could she do? -> What she could do?
 b. What could I have done with the check? ->
 What could have I done with the check?

We see from the examples in (20) that auxiliary verbs undergo movement errors; for example, in (20a), *been* is shifted to the position before *find*, and in (20b), the contracted auxiliary appears after *something*.

- (20) a. any map that I've been able to find ->
 any map that I'm able to been find
 b. Something fishy's going on -> Something's fishy going on

As shown in the data in (21), it is possible for auxiliaries to be deleted as a unit. This is also possible with main verbs, as shown in (22a), however, recall that main verbs may also appear with the stem deleted and inflection stranded, as indicated by the example in (22b) (repeated from (7) in section 3.3 above).

- (21) a. If transformations simplify active perception how come
 ambiguities are created ->
 If transformations simplify active perception how
 come ambiguities created
 b. The doctor said you should have been dead 20 years ago ->
 The doctor said you should be dead 20 years ago
- (22) a. Seventy-five percent is not doing too well ->
 Seventy-five percent is not too well
 b. As I keep suggesting -> As I keeping

We see from the examples in (23) that it is possible for an auxiliary verb to be replaced by another auxiliary verb.

- (23) a. When everybody had left -> When everybody was left

- b. I'm really surprised I've been here as long as I have ->
I'm really surprised I've been here as long as I am

Similar lexical replacement errors are of course common with main verbs as well, as indicated by the examples in (24).

- (24) a. Leonard really needs no introduction ->
Leonard really deserves no introduction
- b. You have to talk with food in your mouth ->
You have to eat with food in your mouth -- have to
talk with food...

The data in (25) indicates that auxiliary verbs undergo local agreement errors, where the verb agrees not with the head of the subject, but with a closer item¹ (see Pfau 2003 for discussion).

- (25) a. My work on speech errors has shown ... ->
My work on speech errors have shown ...
- b. Our main criticisms of the transformationalist generative
approach are ->
Our main criticisms of the transformationalist
generative approach is
- c. ...because I had basic doubts about certain points I was
working on ->
...because I had basic doubts about certain points I
were working on

The examples in this section have shown that auxiliary verbs do undergo a variety of structural speech errors, and therefore the lack of separation errors with auxiliaries cannot be understood as a frequency effect.

6. Spanish speech errors

I now turn to a discussion of spontaneous speech errors in Spanish involving verbal inflection. Interestingly, we observe that in Spanish, unlike in English, we find examples where verbal stem and affix are separated in auxiliary verb as well as in main verb constructions (all speech errors in Spanish are from del Viso 1996).

6.1 Reversal errors

We observe errors in Spanish where the inflectional material of two main verbs is reversed, shown by (26a), as we have for English, shown by (26b) (repeated from (6) in section 3.2 above). The sentence in (27) indicates that errors involving reversal of inflectional material between an auxiliary verb and a main verb are also possible in Spanish, unlike the pattern in English.

- (26) a. ¡Si no es dejar colgao a nadie!->¡Si no es dejao colgar a nadie!
 if not is to leave suspended to no one
 'If it isn't (like) leaving someone hanging'
- b. I saw him digging up those bulbs -> I see him dugging up ...
- (27) Habría que haber barrido -> Habría que habido barrer
 have.1p.s.cond that to have swept
 'One should have swept'

6.2 Movement errors

The examples in (28) show that errors involving movement of the inflectional material away from the verb are also possible with both main (28a) and auxiliary verbs (28b) in Spanish.

- (28) a. Mamá, Dolores quiere que vayas ->
 Mama, Dolores want.3ps that go.2ps.
 Mamá, Dolores quieres que vaya
 'Mama, Dolores wants you to go'
- b. No la has roto tú, hija -> No la ha rotos tú, hija
 not it have.2ps broken you, girl
 'You haven't broken it, honey'

6.3 Deletion errors

Note that, unlike the pattern observed in English, in Spanish an auxiliary verb may be deleted, stranding its inflectional material, which is then realized on the main verb, as in (29).

- (29) Más sano no puede parecer -> Más sano no parece
 more healthy not can.3p.s. to seem
 'He/she/it could'nt be healthier'

7. Spanish versus English errors

A summary of the data from English and Spanish errors is provided in (30).

(30) Separation Errors in English and Spanish Main and Auxiliary Verbs

English	main verb	13
	auxiliary verb	0
Spanish	main verb	15
	auxiliary verb	5

In section four, we explained the contrasting behavior of main and auxiliary verbs in English errors by adopting the hybrid theory of inflection, according to which main verbs are constructed out of syntactically separate stem and affix, while auxiliary verbs are a single structural unit. Thus, we can explain the different pattern of errors in Spanish by claiming that in this language, both main and auxiliary verbs are constructed out of syntactically separate stem and affix, as in the structures in (31) (see Stjepanovic 2000 for relevant discussion of the verbal morphology of Serbo-Croatian). Therefore, Spanish auxiliary verbs, as well as main verbs, allow separation and manipulation of inflectional morphology in speech errors.

- (31) a. Pablo lee el libro
 Pablo read-pres-3ps the book
 Pablo [pres] read the book
 I
 'Pablo is reading the book'
- b. Pablo está leyendo el libro
 Pablo be-pres-3ps reading the book
 Pablo [pres] be reading the book
 I
 'Pablo is reading the book'

Recall that Lasnik argued that in English, main verbs license non-parallel VP ellipsis due to the fact that they are separated from inflection at a certain level of representation, however auxiliary verbs, not being separated from inflection at any level of representation, do not permit non-parallel ellipsis structures. We therefore predict that Spanish permits non-parallel ellipsis with both main and auxiliary verbs. However, as has been discussed in the literature on ellipsis (Zagona 1988, Martins 1994), Spanish does not permit VP ellipsis in general, and therefore we cannot investigate this prediction with respect to this language.

8. Conclusion

To summarize the main points of this paper, I have argued that the different behavior of main and auxiliary verbs in English spontaneous speech errors lends support to the hybrid theory of verbal inflection of Lasnik (1995); main verbs are constructed out of structurally distinct stem and affix, and are thus able to undergo speech errors where stem and affix are manipulated as separate units, while auxiliary verbs form a single unit, and thus are not attested in errors involving separation of stem and affix.

I have shown that, in contrast to English, Spanish displays spontaneous speech errors involving separation of stem and affix with both main and auxiliary verbs, and I have argued that this is due to the fact that in Spanish, both main and auxiliary verbs are constructed out of a base plus affix.

Since Lasnik argues that the licensing of non-parallel VP ellipsis is dependent upon separation of verbal stem and inflection, the cross-linguistic analysis of speech errors outlined here predicts that languages which show errors of separation with both main and auxiliary verbs are those languages in which non-parallel VP ellipsis is licensed with both types of verb. As mentioned in section seven, we cannot check this prediction in Spanish because this language does not have VP ellipsis constructions. The investigation of this correlation in other languages awaits future research.

References

- Anwar, M.S. (1981), "The legitimate fathers of speech errors", *Historiographia Linguistica* VIII,3.
- Anwar, M.S. (1979), "Remarks on a collection of speech errors", *International Journal of Psycholinguistics*, 6, 59-72.
- Becker, D.A. (1979), "Speech error evidence for autosegmental levels", *Linguistic Inquiry*, 10, 165-167.
- Berg, T. (1987), "The case against accommodation: Evidence from German speech error data", *Journal of Memory and Language*, 26, 277-299.
- Berg, T. & H. Abd-El-Jawad. (1996), "The unfolding of suprasegmental representations: A cross-linguistic perspective", *Journal of Linguistics*, 32, 291-324.
- Cutler, A. (1982a), *Speech errors: A classified bibliography*. Bloomington: Indiana University Linguistics Club.

- Cutler, A. (1982b), *Slips of the tongue and language production*. Berlin: Mouton de Gruyter.
- del Viso, S. (1996), "Corpus de errores espontáneos del habla", Ms., Universidad de Oviedo.
- Dell, G. S. (1986), "A spreading-activation theory of retrieval in sentence production", *Psychological Review*, **93**, 283-321.
- Fay, D. (1980), "Transformational errors", in V. Fromkin (ed.), *Errors in linguistic performance*, New York: Academic Press, Inc., 111-122.
- Fromkin, V. (1971), "The non-anomalous nature of anomalous utterances", *Language*, **47**:27-52.
- Fromkin, V. (1980), *Errors in linguistic performance: Slips of the tongue, ear, pen, and hand*, New York: Academic Press, Inc.
- Fromkin, V. (1988), "Grammatical aspects of speech errors", in *Linguistics: The Cambridge Survey, Vol. 2*. F. Newmeyer, (ed.), Cambridge: Cambridge University Press, 117-138.
- Francis, W.N. and Kučera, H. (1982), *Frequency analysis of English usage: Lexicon and grammar*, Boston: Houghton Mifflin.
- Garrett, M.F. (1975), "The analysis of sentence production", in G. Bower (ed.), *Psychology of learning and motivation, Vol.9*. New York: Academic Press, 133-177.
- Lasnik, H. (1995), "Verbal morphology: Syntactic structures meets the Minimalist Program", in *Evolution and revolution in linguistic theory*, H. Campos and P. Kempchinsky (eds.), Washington, D. C.: Georgetown University Press, 251-275.
- Levelt, M. (1989), *Speaking: From intention to articulation*. Cambridge: MIT Press.
- Martins, A.M. (1994), "Enclisis, VP-deletion and the nature of Sigma", *Probus*, **6**:173-205.
- Pfau, R. (2003), "Defective feature copy and anti-agreement in language production, in *The role of agreement in natural language: Texas Linguistics*

- Forum 53 proceedings*, W.E. Griffin (ed.), 95-108.
- Pfau, R. (2000), *Features and categories in language production*, Ph.D. dissertation, Johann Wolfgang Goethe-University, Frankfurt/Main.
- Potsdam, E. (1996), "English verbal morphology and VP ellipsis", in *Proceedings of the 27th Meeting of the North Eastern Linguistic Society*, 27, GLSA, University of Massachusetts, Amherst, 353-368.
- Roberts, E.W. (1975), "Speech errors as evidence for the reality of phonological units", *Lingua*, **35**, 263-296.
- Stemberger, J.P. (1984), "Length as a suprasegmental: Evidence from speech errors", *Language*, **60**, 895-913.
- Stemberger, J.P. and B. MacWhinney. (1986), "Frequency and the lexical storage of regularly inflected forms". *Memory and Cognition*, **14** (1), 17-26.
- Stemberger, J.P. (2002), "Overtensing and the effect of regularity", *Cognitive Science*, **26**: 737-766.
- Stjepanovič, S. (2000), "VP ellipsis in a verb raising language: Implications for verbal morphology", Ms., University of Connecticut.
- Warner, A. (1986), "Ellipsis conditions and the status of the English copula", in *York Papers in Linguistics*, **12**, 153-172.
- Wells-Jensen, S. (1999), *Cognitive correlates of linguistic complexity: A cross-linguistic comparison of errors in speech*, Ph.D. Dissertation, SUNY- Buffalo.
- Zagona, K. (1988), *Verb Phrase Syntax*, Dordrecht: Kluwer.

* I would like to thank the audiences at the Chronos 6 Conference at the University of Geneva and the Twenty-Fourth West Coast Conference on Linguistics at the University of Southern California, Los Angeles, for discussion of this research. I wish to extend my appreciation to Susana del Viso for making available to me her database of Spanish speech errors (del Viso 1996). I also want to thank Bo Lisa Yang for her assistance with the data presented here, and Carson Schutze for his help with the UCLA Speech Error Corpus. For

discussion of this work, I am grateful to Marcela Depiante, Stefan Engelberg, and Jairo Nunes.

I understand here a spontaneous speech error to be an unintended deviance from what the speaker meant to say. Thus, we do not include in this class non-standard usages, errors of language acquisition, or errors due to pathology.

² It is important to keep in mind that these errors are deviances from what the speaker intended to say, and thus are to be distinguished from examples where the speaker intends to utter the form with local agreement. For example, when a speaker says, *The different behavior of main and auxiliary verbs in English spontaneous speech errors lend support to the hybrid theory of inflection of Lasnik (1995)*, the speaker may have intended to say *lend*, due to a processing effect of locality. This is therefore not a spontaneous speech error, and it illustrates the importance of knowing the intention of the speaker before one can classify the error.

Linguistics Program
Department of English
DM 466C
Florida International University
Miami, FL 33199

thompson@fiu.edu

Torne Sámi Causatives: A Reconsideration of *Faire Par*

Mikael Vinka
Umeå University

1. Introduction

Ever since Kayne (1975), it is well-known that sentences such as (1) and (2) (Chichewa) represent two distinct syntactic strategies to form productive causatives. The most striking difference between (1a) and (2a) is found in the way the causee is realized. In (1a), a so-called *Faire Infinitive* (FI) construction, the causee is an argument, in this case, expressed as a direct object, while in (1b), a *Faire Par* causative (FP), an optional *by*-phrase instantiates the causee.

- (1) *Faire Infinitive* (Chichewa, Alsina 1992:518)
- a Nungu i-na-phik-its-a kadzidzi maungu.
porcupine S-Pst-cook-Cause-FV owl pumpkins
'The porcupine caused the owl to cook the pumpkins.'
- b [... Cause [_S DP_{Causee} VP]...] (Burzio 1986)
- (2) *Faire Par* (Chichewa, Alsina 1992:518)
- a Nungu i-na-phik-its-a maungu (kwa kadzidzi).
porcupine S-Pst-cook-Cause-FV pumpkins by owl
'The porcupine caused the owl/someone to cook the pumpkins.'
- b [... Cause [VP] (by- DP_{Causee})...] (Burzio 1986)

Going back to Burzio (1986), the causative formative in FIs is analyzed as taking a full-fledged clausal complement and consequently the causee is the subject of the embedded complement clause, (1b). In contrast, the causative head in an FP combines with a bare VP, with the result that the embedded domain does not accommodate a canonical subject position. Therefore, the causee surfaces as an adjunct phrase, if it is to be expressed at all, (2b). This analysis makes some clear predictions. Firstly, the causee in an FI should always be an argument, because it is the subject of an embedded clause. Secondly, an FP could not have an argument causee, because there is no embedded subject position. It would not be unreasonable to assume that these implications should

hold the other way as well. That is, if we are confronted by a piece of data where the causee is unambiguously expressed as an argument, this would indicate that the causative is an FI. However, closer examination of the Torne Sámi (Finno-Ugric) causatives like (3) below, where the causee is realized as an accusative direct object, will show that this line of reasoning is flawed. In fact, a number of tests reveals that (3) must be an FP rather than an FI.

- (3) Sii loga-h-edje máná girjji.
 they.Nom read-Cause-Pst.3p child.Acc book.Acc
 'They caused the child to read a book.'

Along these lines, (3) is a variant of the Torne Sámi causative given in (4), where the causee has no realization, and thus conforms to the surface profile of a bona fide FP.

- (4) Sii loga-h-edje girjji.
 they.Nom read-Cause-Pst.3p book.Acc
 'They caused someone to read a book.'

The claim that both (3) and (4) instantiate the same causative type receives ample support when we consider the distributional ranges of FPs and FIs. This will be the topic of section 2. Section 3 will elaborate on these facts, and we adopt a hypothesis pursued in work by Baker & Stewart (1999), Pykkänen (1999) and Vinka (2002), among others, that Chomsky's (1995) little-vP and Kratzer's (1996) VoiP are two distinct syntactic projections, rather than being two different labels for more or less the same thing. We assume that external arguments are introduced into the specifier of VoiP, whereas vP adds a cause or process component to the overall verb phrase, and as such its occurrence plays an important role in the structural encoding of agentivity. Specifically we shall argue that the causative formative in an FP merges with a vP, while in FIs it combines with a VoiP. Section 4 addresses the problem posed by the causee in (3). Here we show that the causee is a true argument. But since its syntactic behavior sharply contrasts with the FI-causee, it must be treated as an optional applied object, in the sense of Marantz (1993). Section 5 concludes the paper.

2. Torne Sámi Causatives are FPs

One of the major, but nonetheless least well-understood distinctions between FIs and FPs concerns the kinds of verbs that may be embedded under causativization. Various studies have brought to general attention the fact that the selectional restrictions imposed on the base verb in FPs are tighter than what is observed in FIs (e.g. Bordelois 1988, Alsina 1992, Guasti 1993). Although the two causative types can successfully combine with agentive base verbs ((1) and

(2) above), they do differ in their ability to embed complements headed by non-agentive perception verbs. (5) witnesses that such verbs may licitly appear in the FI, in contrast to (6), which shows that they are barred in the FP,.

(5) *Faire Infinitive* (Chichewa, Alsina 1992:528)

Chatsalira a-ku-mv-ets-a ana phokoso.
Chatsalira S-Prs-hear-Cause-FV children noise
'Chatsalira is making the children hear the noise.'

(6) *Faire Par* (Chichewa, Alsina 1992:528)

*Chatsalira a-ku-mv-ets-a phokoso (kwa ana)
Chatsalira S-Prs-hear-Cause-FV noise by children
'Chatsalira is making the children/someone hear the noise.'

We now turn our attention the causeless causative in Torne Sámi, whose surface profile matches the FPs (2) and (6). Specifically, if Torne Sámi causatives like (4) are instantiations of the FP, we expect that it should be impossible to generate a sentence based on a non-agentive perception verb. Indeed, as is revealed by the ungrammaticality of (7), this prediction is correct.

(7) *Máhtte gula-h-ii bajána.
Máhtte.Nom hear-Cause-Pst.3s thunder.Acc
'Máhtte caused someone to hear the thunder.'

In contrast, the presence of an argument causee in the Torne Sámi example (3) creates a causative with the distinct look of an FI. One would therefore anticipate that such causatives should be compatible with a non-agentive perception verb in the complement of cause. However, the ungrammaticality of (8) shows that this expectation is at odds with actual facts.

(8) *Máhtte gula-h-ii máná bajána.
Máhtte.Nom hear-Cause-Pst.3s child.Acc thunder.Acc
'Máhtte caused the child to hear the thunder.'

The Torne Sámi situation, then, suggest that not only is the causeless causative an FP, but more surprisingly, so are sentences like (3) and (8), which in all superficial regards resemble FIs. In the next section, we shall present conclusive evidence that (3) and (8) must be FPs.

3. Articulating the Verb Phrase

In this section we propose that Chomsky's (1995) little-vP and Kratzer's (1996) VoiP are two distinct syntactic projections, rather than being two different labels

for more or less the same thing. We then continue to show that Torne Sámi causatives uniformly are of the FP variety.

3.1 Splitting Voi and v

Baker & Stewart (1999), Pylkkänen (1999), Vinka (2002), Svonni & Vinka (2003) among others, have proposed that, contrary to standard assumptions, Chomsky's (1995) little-vP and Kratzer's (1996) Voi(ce)P perform different tasks in the articulated neo-Larsonian VP. Following Baker & Stewart (1999) and Vinka (2002), I assume that Voi is responsible for introducing the external argument. Furthermore, Baker & Stewart (1999) argue that Chomsky's (1995) little-vP is selected by Voi and realizes a cause or process component. Hence, a plain transitive agentive verb phrase will be associated with the structure shown in (9).

(9)

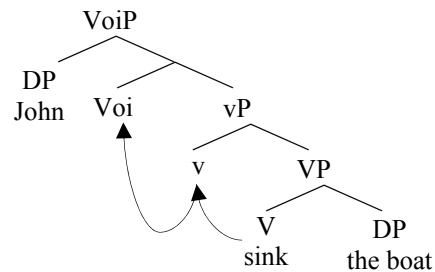

Let us further hypothesize that non-agentive transitive verbs are structurally distinct from agentive verbs. In non-agentive contexts Voi merges directly with VP, yielding (10) below, where no vP is present. The implication of this proposal is that agentivity is a structural (viz. *syntactic*) notion, a direct reflection the structural components that form the spine of the verbal complex.

(10)

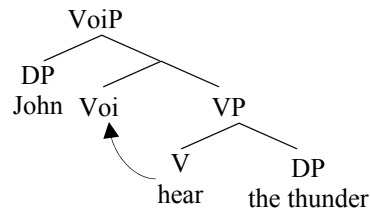

Several factors support the suggested decomposition. For instance, since transitive verbs such as sink and hear can easily be passivized, they involve an argument-introducing Voi projection. However, the thematic content of the external arguments are different, agent versus experiencer. It is well known that

this thematic asymmetry is reflected in each verb's ability to license agent-oriented material, such as rationale clauses, as illustrated in (11) (Faraci 1976, Roberts 1987, Roeper 1987, Jones 1991). The verb sink in (11a) has the right syntactic structure to support the presence of a rationale clause, namely the constellation Voi-v. In contrast, although the verb hear in (11b) has an external argument introduced by Voi projection, the absence of little-v disqualifies the verb as a licenser of a rationale clause.

- (11) a [_{VoiP} John **Voi** [_{VP} v [_{VP} sank the boat] [PRO to collect the insurance]]].
 b * [_{VoiP} John **Voi** [_{VP} heard the thunder] [PRO to study the weather]].

3.2 The structure of *faire par*

Under the standard theory of FPs (Burzio 1986), the causative formative selects a bare VP-complement (see (2b) above). While this analysis correctly predicts that the complement is structurally too small to host an external argument, it does not provide an explanation why the FP imposes more stringent selectional restrictions on its complement, than the FI. Several attempts have been made to account for the selectional asymmetries by hypothesizing that FPs impose an additional requirement that the base object be an affected argument (Alsina 1992, Guasti 1993, Authier & Reed 2003). However, Svonni & Vinka (2003) and Vinka (2002, to appear) point out several cases where the affectedness hypothesis either over-generates or is too restrictive. Another school of thought has proposed that the contrast between (2) and (6) can be captured if the causative formative in an FP selects for agentive verbs (Guasti 1990, Travis 1991). While this hypothesis identifies the right set of verbs that are compatible with FPs, it is both conceptually and empirically challenged. Conceptually, it strains the notion of s-selection. Empirically, it implies that the embedded domain in an FP should show non-trivial signs of agentivity, which as we immediately shall see is incorrect.

The Italian FI (12) shows that PRO in the infinitival rationale clause may take its reference from the causee, which is predicted by the hypothesis that the causee in FIs is a bona fide subject (cf. (1b)).

- (12) Il sindaco ha fatto costruire il monumento a architetto Nervi_i
 the mayor has made build the monument Dat architect N
 [per PRO_i ottenere appoggi politico].
 in order to obtain support political
 'The mayor caused the architect Nervi to build the monument PRO to
 obtain political support.'
 (Guasti 1993:100)

However, the situation in FPs is different. (13a) shows that regardless of whether the causee is realized or not, it does not qualify as a controller of PRO.

In this sense FPs differs sharply not only from FIs, but also from standard passive sentences, as the contrast between (13a) and (13b) illustrates.

- (13) a *Il sindaco ha fatto costruire il monumento (dall' architetto Nervi)_i
 the mayor has made build the monument by architect N
 [per PRO_i ottenere appoggi politico].
 in order to obtain support political
 'The mayor caused the architect Nervi to build the monument PRO to
 obtain political support.'
 (Guasti 1990:207)
- b Questo edificio é stato costruito (dall' architetto Nervi)_i
 this building is been built by the architect Nervi
 [per PRO_i ottenere appoggi politici]
 in order to obtain support political
 'This building has been built by the architect Nervi, in order to obtain
 political support.'
 (Guasti 1990:207)

In other words, the FP causative requires that the base verb be *potentially* agentive, rather than agentive. This is so because once the verb is embedded under FP, it is robbed of its agentivity.

With this as a backdrop, let us now consider the licensing possibilities of rationale clauses in Torne Sámi causatives. As expected the causeless variant (14), patterns like the Italian FP (13a). That is, the implicit causee (rendered IMP for expository purposes) cannot control into the infinitival rationale clause.

- (14) *Máhtte vuojuh-aht-ii IMP_i fatnasa
 Máhtte.Nom sink.Tr-Cause-Pst.3s boat.Acc
 [PRO_i beahttin dihte dáhkádussearvvi].
 cheat.Inf in-order-to insurance company.Acc
 'Máhtte caused someone to sink the boat in order to cheat the
 insurance company.'

When we consider the licensing of rationale clauses in causatives with an overt causee, the hypothesis that Torne Sámi only accommodates FPs gains further support. (15) show that the PRO contained in the rationale clause cannot take its reference from the accusative causee. If (15) is an FP, as we contend, the judgment is fully expected.

- (15) *Máhtte vuojuh-aht-ii Máreha_i fatnasa
 Máhtte.Nom sink.Tr-Cause-Pst.3s Máret.Acc boat.Acc
 [PRO_i beahttin dihte dáhkádussearvvi].
 cheat.Inf in-order-to insurance company.Acc
 'Máhtte caused Máret to sink the boat in order to cheat the
 insurance company.'

We can now provide a straightforward account for the contrast between FIs and FPs. The causative formative in FIs selects a VoiP complement, (16), which explains the fact that FIs can be based on agentive as well as non-agentive verbs, and the fact that the complement of cause can license agent-oriented material.

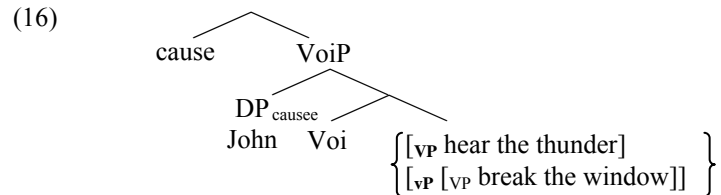

FPs, on the other hand, can only be based on potentially agentive verbs. Agentivity, we have proposed, is a structural notion, namely the combination of Voi and v. Since it is independently known that the complement that the causative formative combines with cannot involve VoiP, we claim that that the categorial status of the complement phrase is a vP, (17).

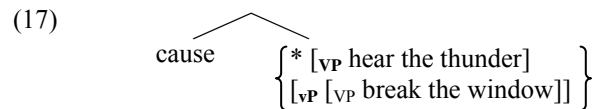

In short, by assuming that FIs select for a VoiP complement and FPs for a vP complement, we have a straightforward account for the fact that FIs can be formed from a wider range of verbs than FPs. Moreover, we have an account for the appearance that FPs only select agentive verbs. Because v is a crucial ingredient in agentive verbs, but since v itself does not encode agentivity, it follows that the complement of the causative head is void of agentivity as such.

4. The Torne Sámi Causee

Having concluded that Torne Sámi causatives are FPs, we shall now investigate the properties of the causee. We argue that the accusative causee is an applied object, parallel to what is found in benefactive constructions. That is, the Torne Sámi causee is on the one hand an argument, and on the other hand it is optional.

4.1 The Causee is an argument

In their work on sluicing, Chung, Ladusaw & McCloskey (1995) demonstrated, as shown in (18), that direct object benefactives can appear in the sluice only if there is a corresponding argument in the antecedent IP, (18a) versus (18b).

Prepositional benefactives do not exhibit this restriction, (18c) versus (18b) (see Merchant (2001) for a detailed discussion).

- (18) a John bought *someone* a book, but I don't know *who*.
 b *John bought a book, but I don't know *who*.
 c John bought a book, but I don't know *to who*.

Sluicing in Sámi causatives behaves in a similar fashion. Consider (19). The grammatical (19a) hosts the wh-phrase gean 'who.Acc' (the causee) in the sluice. The antecedent IP hosts an overt causee, namely soapmása 'someone.Acc,' comparable to (18a). In contrast, (19b) is illicit. Here the wh-phrase in the sluice instantiates the causee, but there is no syntactically realized causee in the antecedent IP, yielding (19b) ungrammatical, on a par with (18b).

- (19) a Máhtte cuvke-h-ii soapmása láse,
 Máhtte.Nom break-Cause-Pst.3s someone.Acc window.Acc
 muhto in dieđe gean.
 but Neg.1s know.Prs who.Acc
 'Máhtte caused someone to break the window, but I don't know who.'
 b *Máhtte cuvke-h-ii láse,
 Máhtte.Nom break-Cause-Pst.3s window.Acc
 muhto in dieđe gean.
 but Neg.1s know.Prs who.Acc
 'Máhtte caused *someone* to break the window, but I don't know who.'

In fact, the relevant sluicing facts in Sámi are also identical to what is found in French FIs (Coppelle Cocq, p.c). (20a) shows that if the wh-phrase in the sluice expresses a dative causee, then there must be a dative causee present in the antecedent clause. However, the FP (20b) shows that no comparable restriction is found with the by-phrase causee, on a par with the benefactive (18c).

- (20) a Elles ont fait peindre la maison *(à quelqu'un),
 they have made paint the house Dat someone
 mais je ne sais pas à qui.
 but I don't know Dat who
 'They have made someone paint the house, but I don't know who.'
 b Elles ont fait peindre la maison (par quelqu'un),
 they have made paint the house by someone
 mais je ne sais pas par qui.
 but I don't know by who
 'They have made someone paint the house, but I don't know who.'

Thus, sluicing facts suggest that the Torne Sámi causee is a true argument.

4.2 The Torne Sámi causee is an applied object

We have seen that the surface expression of the causee in a Torne Sámi causative like (3a) is identical to the expression of the causee in FIs, (1). Nonetheless, we have also shown that (3a) must be an FP, on a par with (2a), in spite of superficial appearances. The Sámi accusative causee and, say, the Chichewa *by*-phrase causee share the characteristic of being entirely optional, unlike the causee in FIs. As we saw above, there are strong parallels to double object and prepositional ditransitive constructions, further illustrated in (21) and (22):

- (21) a Peter gave a book *to Sally*.
 b Peter gave *Sally* a book.
 (22) a Peter read a book *for Sally*.
 b Peter read *Sally* a book.

The basic difference between (21) and (22) is that in the former the goal phrase is obligatory whereas in the latter the benefactive phrase is not. Furthermore, some languages do not permit prepositional datives comparable to (21a) and (22a), for instance Sesotho (Machobane 1989:113):

- (23) a Ntate o-f-a bana lijo.
 father S-give-FV children food
 'My father gives the children some food.'
 b *Ntate o-f-a lijo ho bana.
 father S-give-FV food to children
 'My father gives some food to the children.'

Other languages have been suggested to be the opposite of Sesotho, only allowing the prepositional phrase (for instance Baker (1988)), as shown by the following Brazilian Portuguese sentence (Sônia Katsuura .p.c.):

- (24) a Eu li um livro para Leila.
 I read a book for Leila
 'I read a book for Leila'
 b *Eu li Leila um livro.
 I read Leila a book
 'I read Leila a book.'

We are now in a position where we can view Torne Sámi, (25a) below, as the FP-causative counterpart to Sesotho ditransitives (23), whereas the Chichewa FP (25b) is the counterpart to Romance ditransitives (24).

- (25) a Sii loga-h-edje (máná) girjji.
 they.Nom read-Cause-Pst.3p child.Acc book.Acc
 'They caused the child/someone to read a book.'
- b Nungu i-na-phik-its-a maungu (kwa kadzidzi).
 porcupine S-Pst-cook-Cause-FV pumpkins by owl (cf. (2a))
 'The porcupine caused the owl/someone to cook the pumpkins.'

There is a broad consensus that the first object in double object constructions is introduced into the specifier of an applicative phrase (e.g. Marantz (1993), McGinnis (1998) and Ura (1996), among several others). The different expressions of the causee in (25) can be stated in the same terms as the double object and adpositional constructions; in both cases a certain participant is expressed either as a primary object or as an adpositional object. The Causee is in particular similar to benefactives in this regard, since neither is obligatory. So, if a goal or benefactive object can be introduced by an applied head or by an adposition, the most straightforward solution for (25) is to assume that the Torne Sámi causee is an applied argument. In other words, in FPs where the Causee has distinct argument properties, (25a), we assume that it is introduced into the specifier of an applicative phrase (26a) – labeled Appl-C, where C stands for causee – whereas the adjunct *by*-phrase Causee (25b) uncontroversially is a PP (26b). Importantly, this analysis also receives support from the sluicing facts presented above.

- (26) a [_{VoiP} they Voi [_{ApplP-C} **child** Appl-C [_{causeP} Cause [_{VP} read book]]]]
 b [_{VoiP} porcupine Voi [_{causeP} Cause [_{VP} cook pumpkin]](**by owl**)]

5. Conclusions

This paper has investigated the syntax of productive morphological causatives in the Finno-Ugric language Torne Sámi. We situated the Torne Sámi causative in Kayne's (1975) typology, and we have argued that the language only accommodates the FP causative, although the expression of the causee, which we treat as an applied object, would have suggested otherwise. We have furthermore argued that the behavior of the FP causative provides evidence that Kratzer's Voi and Chomsky's little-*v* have distinct syntactic properties.

Notes

Thanks are due to the audience at WECOL 2004 at USC for helpful comments, also to Mark Baker, Coppelie Cocq, Lotus Goldberg, Hiro Hosoi, Sônia Katsuura, Hanna Outakoski, Norvin Richards, Peter Svenonius, Mikael Svonní, Naoko Tomioka, and Lisa Travis. This research has been partially funded by the Swedish Research Council's project *Förstärkning av forskarmiljöer i samiska språk*. The usual disclaimers apply.

References

- Alsina, Alex. 1992. "On the Argument Structure of Causatives," *Linguistic Inquiry*, 23.4: 517-555.
- Authier, Marc, & Lisa A. Reed. 2003. "Quantifier Scopepe and the Structure of Faire-Par," In *Romance Linguistics: Theory and Acquisition*, eds. Ana Teresa Pérez-Leroux & Yves Roberge, 19-32. Amsterdam/Philadelphia: John Benjamins Publishing Company Ltd
- Baker, Mark. 1988. *Incorporation, a Theory of Grammatical Function Changing*. Chicago: Chicago University Press.
- Baker, Mark, & Osamuyien T. Stewart. 1999. On Double Headedness and the Anatomy of the Clause. Ms. Rutgers University.
- Bordelois, Ivonne. 1988. "Causatives: From Lexicon to Syntax," *Natural Language and Linguistic Theory*, 6.1: 57-93.
- Burzio, Luigi. 1986. *Italian Syntax: A Government-Binding Approach*. Dordrecht: Reidel.
- Chomsky, Noam. 1995. *The Minimalist Program*. Cambridge, Mass: MIT Press.
- Chung, Sandra, William A. Ladusaw, & James McCloskey. 1995. "Sluicing and Logical Form," *Natural Language Semantics*, 3.3: 239-282.
- Faraci, Robert. 1976. Aspects of the Grammar of Infinitive and for Phrases, MIT: Ph.D.
- Guasti, Maria-Teresa. 1990. "The Faire-Par Construction in Romance and Germanic," In *Proceedings of the West Coast Conference on Formal Linguistics*, ed. Aaron. L Halpern, 205-218. Stanford: CSLI
- Guasti, Maria-Teresa. 1993. *Causative and Perception Verbs*. Torino: Rosenberg & Sellier.
- Jones, Charles. 1991. *Purpose Clauses: Syntax, Thematics, and Semantics of English Purpose Constructions*. Dordrecht: Kluwer.
- Kayne, Richard. 1975. *French Syntax: The Transformational Cycle*. Cambridge, Mass: MIT Press.
- Kratzer, Angelika. 1996. "Severing the External Argument from Its Verb," In *Phrase Structure and the Lexicon*, eds. Johan Rooryck & Laurie Zaring, 109-137. Dordrecht: Kluwer
- Machobane, Malillo Matsepo. 1989. Some Restrictions on the Sesotho Transitivity Morphemes, McGill University: Ph.D.
- Marantz, Alec. 1993. "Implications of Asymmetries in Double Object Constructions," In *Theoretical Aspects of Bantu Grammar*, ed. Sam Mchombo, 113-150. Stanford: CSLI
- McGinnis, Martha Jo. 1998. Locality in A-Movement, MIT: Ph.D.
- Merchant, Jason. 2001. *The Syntax of Silence: Sluicing, Islands, and the Theory of Ellipsis*. Oxford: Oxford University Press.
- Pylkkänen, Liina. 1999. "Causation and External Arguments," In *Papers from the Second Penn/MIT Roundtable on Argument Structure and the Lexicon*, eds. Liina Pylkkänen, Angeliek van Hout & Heidi Harley, 161-183. Cambridge, Mass: MITWPL.
- Roberts, Ian. 1987. *The Representation of Implicit Arguments*. Dordrecht: Foris.
- Roeper, Thomas. 1987. "Implicit Arguments and the Head-Complement Relation," *Linguistic Inquiry*, 18.2: 267-310.
- Svonn, Mikael, & Mikael Vinka. 2003. "Constraints on Morphological Causatives in Torne Saami," In *Generative Approaches to Finnic and Saami Linguistics*, eds. Satu Manninen & Diane Nelson, 343-380. Stanford: CSLI Publishers
- Travis, Lisa. 1991. "Inner Aspect and the Structure of VP," *NELS* 22.

- Ura, Hiroyuki. 1996. Multiple Feature Checking: A Theory of Grammatical Function Splitting, MIT: Ph.D.
- Vinka, Mikael. 2002. Causativization in North Sámi, McGill University: Ph.D.
- Vinka, Mikael. to appear. "Base Objects," In *The Main Session: Proceedings of the 40th Annual Meeting of the Chicago Linguistic Society*. Chicago: Chicago Linguistic Society

Mikael Vinka
Umeå University
Sámi Studies
901 87 Umeå, Sweden
mikael.vinka@samiska.umu.se

Nominal Appositives in Context

Linton Wang, Eric McCready, Brian Reese

University of Texas at Austin

This paper defends two claims concerning the interpretation of nominal appositives: (1) the content of an nominal appositive and a main clause often interact with each other in interesting ways and (2) nominal appositives and appositive relative clauses exhibit important semantic differences. These claims diverge from previous proposals. We support them with various kinds of evidence regarding the interpretation of nominal appositives.

1 Introduction

Abstracting away from the specifics of implementation, most accounts of the semantic contribution of nominal appositives assume that they introduce a sentential meaning that is independent of the contribution of the main clause. We refer to this assumption as the *semantic independence assumption (SIA)* or as simply the independence assumption. For example, the interpretation of (1), from Dever (2001), is treated as two independent assertions, (2a) and (2b), which may make different discourse contributions (Potts 2005, Chierchia & McConnell-Ginet 1993) or as two assertions linked by inter-sentential anaphora as in (3) (del Gobbo 2003, Dever 2001, Sells 1985).

- (1) Plato, the greatest metaphysician of antiquity, wrote the *Cratylus*.
- (2)
 - a. Plato wrote the *Cratylus*.
 - b. Plato was the greatest metaphysician of antiquity.
 - c. $\langle At - Issue : (2a), CI : (2b) \rangle$
 - d. $\langle Assertion : (2a), Background : (2b) \rangle$
 - e. *Conjunction* $\langle (2a), (2b) \rangle$.
- (3) Plato wrote the *Cratylus*. He was the greatest metaphysician of antiquity.

Theories that take (1) to have the interpretation in (2a) or (2b) are referred to as *full antecedent recovery* (FAR) approaches since (2b) is the result of recovering the full antecedent of the nominal appositive, *Plato*. Different versions of this approach treat the relation between (2a) and (2b) differently. Potts (2005), as shown in (2c), takes (2a) to be the main assertion, or to provide the “at issue” content of the utterance, and (2b) to be a conventional implicature (CI) of (1). Chierchia & McConnell-Ginet (1993), as shown in (2d), treat (2a) as the main assertion and (2b) as background information. No one explicitly endorses (2e), the conjunction of (2a) and (2b). Theories that assume that (1) has the interpretation shown in (3) are referred to as *anaphoric antecedent recovery* (AAR) approaches since (3) is the result of recovering the antecedent for the appositive in (1) using an anaphoric pronoun.

We introduce data in this paper that show that appositives and main clauses interact in complex ways, often affecting each other’s interpretation. The independence assumption is discussed in some detail in section 2. Pros and cons for it are provided in section 3. Only nominal appositives are considered there. Section 4 incorporates appositive relative clauses into the discussion. We show that appositive relative clauses are semantically very different from nominal appositives, contrary to some claims in the literature. We refer to a sentence that contains an appositive an *appositive containing sentence* (ACS).

2 Previous Proposals

As stated above, two main approaches to appositives exist: the FAR approach and the AAR approach. Both of these approaches endorse the independence assumption; that is, they assume that the meaning of the main clause and nominal appositive are computed independently of each other.

2.1 Full antecedent recovery

The full antecedent recovery approach has its origin in Chierchia & McConnell-Ginet (1993) and is developed further by Potts (2005). We focus on Potts’ version of this approach below.

According to Potts (2005), the main clause in an ACS contributes the sentence’s *at issue* content, while the appositive contributes a so-called *conventional implicature* (CI). Potts (2005) models these two aspects of meaning using a multi-dimensional semantics; at issue content and conventional implicature represent different dimensions of sentence meaning. Adding an appositive to a sentence adds a dimension to a sentence’s meaning.

On Potts’ account, at issue content and CI are computed according to the rules in (4).

- (4) a. At-issue meanings apply to at issue meanings to produce at-issue meanings.
 b. CI meanings apply to at-issue meanings to produce CI meanings.

In this framework, the interpretation of any utterance is a tuple. At issue content is one element of the tuple and all expressive content introduces extra, independent, elements.

As a concrete example, consider the derivation of the meaning of (5) given the syntactic analysis in (6).

- (5) Kaplan, a professor at UCLA, got a promotion.

The appositive clause *a professor at UCLA* is associated with a feature COMMA (related to comma intonation) that is interpreted expressively.

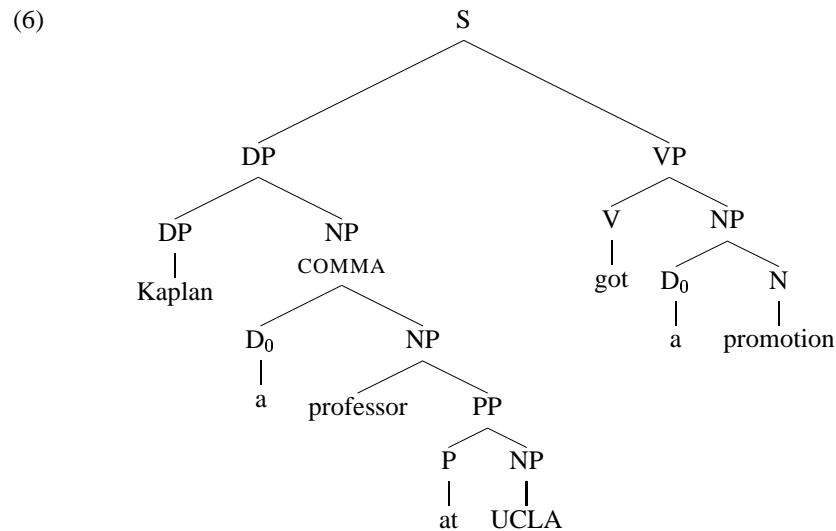

The COMMA feature is a type-shifting operator, here with the following type and meaning:

- (7) $\text{COMMA} = \lambda f. \lambda x. f(x) : \langle \langle e^a, t^a \rangle, \langle e^a, t^c \rangle \rangle$

The meaning composition tree associated with this syntactic representation is shown in (8). The indefinite *a professor at UCLA* here must be given a predicative interpretation.

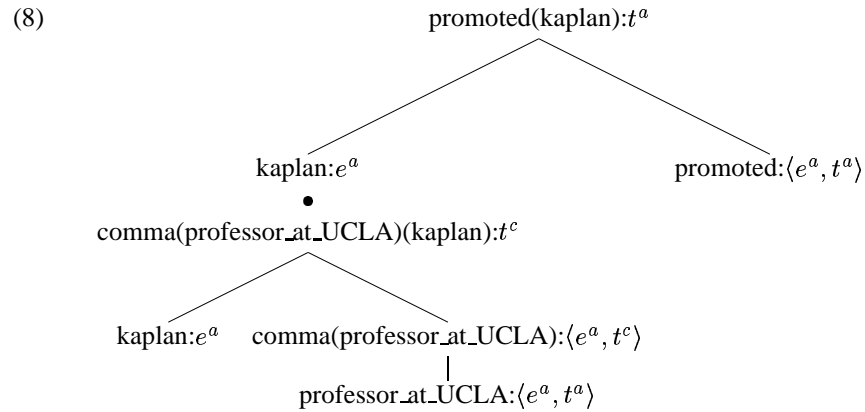

Potts (2005) ensures that CI content in non-root nodes is not interpreted in the scope of other operators by using the following evaluation schema (shown in a simplified version).

$$(9) \quad [\alpha : \sigma^a \bullet \beta : \tau^c]^{M,g} = \langle [\alpha : \sigma^a]^{M,g}, [\beta : \tau^c]^{M,g} \rangle \quad (\text{Potts 2003: 61})$$

α and β are variables over lambda terms, and σ^a and τ^c are variables over semantic types. The superscripts distinguish the types as either at-issue (superscript a) or CI (superscript c). The bullet mark \bullet is used to separate independent formulae. In this way, **content** ^{c} can be pulled out of lower nodes and inserted directly into a final meaning tuple. This means that appositives introduce content into the second part of the tuple, resulting in:

$$(10) \quad \langle \textit{promoted}(\textit{kaplan}), \textit{professor_UCLA}(\textit{kaplan}) \rangle$$

Summarizing, Potts' framework makes the following assumptions and predications about the interpretation of ACSs:

(11) **Assumption**

- a. At-issue content (main clause content) does not import content from appositive clauses.
- b. There is no special semantic relation between at-issue content and CI (appositive content), except perhaps that CI may provide background information to at-issue content.

(12) **Prediction**

- a. Appositives cannot be denied with simple negations.
- b. Appositives cannot be semantically embedded.

We show that the independence assumption and the predictions that it makes are empirically unsupported.

2.2 Anaphoric antecedent recovery

The anaphoric antecedent recovery approach has its beginnings in Sells (1985). More recent developments, which are the focus of this section, are Dever (2001) and del Gobbo (2003).

Del Gobbo (2003) defends the following claims pertaining to nominal appositives:

- Appositive relative clauses are instances of E-type anaphora (p. 98).
- Nominal appositives can be paraphrased using appositive relative clauses (p. 101).

The first point describes how appositive relative clauses are to be interpreted and forms the basis for the independence assumption. The second point claims that nominal appositives and appositive relative clauses are equivalent. Together, they tell one how to interpret nominal appositives.

According to del Gobbo, then, the meaning of (5), repeated as (13a), can be recovered from the meaning of (13b), which by exploiting discourse anaphora can be paraphrased as (13c).

- (13)
- a. Kaplan, a professor at UCLA, got a promotion.
 - b. Kaplan, who is a professor at UCLA, got a promotion.
 - c. Kaplan got a promotion. He is a professor at UCLA,

Abstracting away from the formal details, both Potts (2005) and del Gobbo (2003) share the semantic independence assumption (11) and the predictions in (12). The approaches diverge in that it is not completely clear whether del Gobbo (2003) predicts (12b) or not since she does not consider such cases. Furthermore, the assumption that nominal appositives are essentially equivalent to appositive relative clauses is incorrect, as shown below.

3 Problems with the Independence Assumption

In this section, we argue that the independence assumption is not empirically supported. Specifically, main clause content and appositive content in an ACS interact in complicated ways. As far as we can see, existing theories cannot handle the data we discuss here.

3.1 Independence of truth evaluation

One argument in favor of the SIA is the observation that the truth conditions of main clauses are independent of those of appositive clauses. The approaches sketched in (2c), (2d) or (3) provide different criteria for evaluating the truth of (1). Consider the following truth value distribution for $\langle (2a), (2b) \rangle$.

- (14) $\langle (2a), (2b) \rangle$
- a. $\langle 1, 1 \rangle$
 - b. $\langle 1, 0 \rangle$
 - c. $\langle 0, 1 \rangle$
 - d. $\langle 0, 0 \rangle$

The FAR approach proposed in Potts (2005) takes the truth value of an ACS such as (1) to be multi-dimensional. The truth value of (1) is represented two dimensionally by the possibilities shown in (14). The first column represents the truth value of the main clause and the second column represents the truth value of the appositive clause. The multi-dimensional semantic framework rejects the possibility of collapsing the two dimensions into a single dimension, true or false. The truth value of the appositive clause, treated as CI or background, does not affect the truth value of the main clause.

One argument in favor of this separation of content comes from *objection tests*, or *denial tests*, as proposed in Karttunen & Peters (1979) (and see also Potts 2005 for more on this issue). For example, one may object to (1) with either (15a) or (15b).

- (15) a. No, that is not true.
 b. Well, yes, but, ...

Potts (2005) argues that the denial in (15a) applied to (1) negates only (2a), the main clause content, leaving (2b) untouched. The objection to (1) in (15b), on the other hand, negates only (2b), leaving (2a) untouched. Since denials of (1) can not apply to both (2a) and (2b) simultaneously, the truth value of (1) must exist on separate planes, so to speak.

The intuitions of the multi-dimensional approach, however, are not as clear cut as it might at first glance appear. Examining each of the truth value pairs in (14), there appear to be cases in which (1) has a one-dimensional truth value. According to Dever (2001), if (2a) and (2b) are both true, then (1) is true. If (2a) and (2b) are both false, then (1) is false. If (2a) is true but (2b) false, then (1) appears to be true. However, if (2a) is false and (2b) true, then (1) is neither clearly true nor false. According to Dever (2001), these intuitions exclude (2e) as a possible

interpretation of (1). The unification of truth values in ACSs raises a problem with the multi-dimensional truth value of Potts (2005).

The truth value intuitions just cited fit well with the AAR approach in (3). The AAR approach believes that appositives are linked to their antecedents via an (covert) E-type pronoun. This approach in fact contains a weak version of the independence assumption. Regardless of how E-type anaphora is implemented, this approach not only captures the intuition about truth values, but also accounts for the objection test. The objection (15a) can be understood as an objection to the first sentence of (3) and the objection (15b) can be understood as an objection to the second sentence of (3). But, as we will see, the E-type approach runs into other problems.

In any case, the results of the denial test are not as clear cut as suggested in Potts (2005). For example, the denial in (16b) is perfectly fine as a denial of the appositive content in (16a).

- (16) a. John got a good grade, an A⁺, on his logic exam.
 b. No, that is not true. (He got an A⁻ on the exam.)

Moreover, a denial can target the rhetorical connection between an appositive clause and main clause, in addition to the appositive or main clause content itself. For example, the denial in (17b) is a denial of the explanation that John has a lot of money because he is a shrewd business man rather than the appositive content alone.

- (17) a. John, a shrewd business man, has a lot of money.
 b. Well, yes, but (the reason why he has a lot of money is because he has a rich wife).

In sum, the FAR approach fails to capture the phenomena in (16) and (17). A better understanding of the denial test is needed. The AAR approach fares well with the data so far, but will run into problems elsewhere, as we now show.

3.2 Specificity

The FAR and AAR approaches agree on two points. They both maintain that main clause content does not impact appositive content. *The only information in main clauses used to construct the appositive content is the antecedent of the appositive clause.* Second, they maintain that appositive content does not affect the interpretation of main clause content. Deleting an appositive clause will not affect the interpretation of the main clause – a widely held view. However, both of these theses are wrong.

With regard to the second point, we note that main clause content can, in fact, be affected by the content of an appositive clause. (18a), for example, is ambiguous

between a *de dicto* and a *de re* reading. In (18b), however, the main clause is unambiguous; it has only a *de re* reading. The ambiguity of (18a) *does not persist* in (18b). (18a) and (18b) constitute a minimal pair and the difference in possible interpretations must be a result of the presence of the appositive clause.

- (18) a. John wants a car. (*de re* and *de dicto*)
 b. John wants a car, the red BMW. (*de re* only)

The content of the nominal appositive – in this case one of its presuppositions – determines whether and how it affects the interpretation of the main clause. If we modify the appositive, eliminating this presupposition, then both readings are again available, as in (19).

- (19) John wants a car, a red BMW.

Note however that approaches which posit an E-type pronoun get this wrong, assuming, as is standard, the use of a definite determiner in the paraphrase of the pronoun: the (covert) definite has the same presuppositions as any other definite, and so these approaches predict that (19) has the same interpretation as (18b), which is wrong.

Appositive clauses can also affect the available quantifier scopings for a sentence. Consider the main clauses in (20a) and (20b), each of which, if used independently, has both an $\forall\exists$ and $\exists\forall$ reading. However, when the appositive clauses in (20a) and (20b) are considered, only one reading remains. *Every* takes wide scope. Again, the ambiguity in the main clause does not persist.

- (20) a. Every man admires exactly one man, himself.
 b. Every man admires exactly two women, his wife and his mother.

The reason for this presumably is that the variables introduced by the pronouns in the appositive would become unbound were the \exists -quantifier, and so the appositive it hosts, to take wide scope.

Next, consider (21a) and (21b). The *de dicto* reading of (21a) is infelicitous, as shown in (21b), but the definite host of the appositive in (22a) means that (22b) is always felicitous. Here, the presuppositions of the antecedent affect that interpretation of the nominal appositive.

- (21) a. A wolf, a big one, might come into your house.
 b. A wolf might come into your house. *It is a big one.
 (22) a. The wolf, a big one, might come into your house.
 b. The wolf might come into your house. It is a big one.

Although the distinction between (21a,b) and (22a,b) does not explicitly show that main clauses affect the interpretation of appositive clauses, it does show that the same appositive clause may exhibit different anaphoric relations with respect to different antecedents. We provide more direct evidence in later sections.

3.3 Background and CI

Previous approaches also differ in what they assume the discourse contribution of an appositive clause to be. For a CI theory of appositives such as Potts (2003), appositive clauses contribute a conventional implicature which provides *background* information for the interpretation of the main clause. We show in this section that this assumption is too simplistic; appositive clauses can make a range of contributions to the interpretation of a discourse.

Appositive clauses can in fact play a variety of roles in the interpretation of a discourse. The appositive clause in (23a), for example, provides *background* information for the main clause content, while the appositive clause in (23b) *elaborates* the information contributed by the main clause (see Asher & Lascarides 2003 for the distinction between *Background* and *Elaboration*).

- (23) a. John, a famous professor, teaches at UT. (Background)
 b. John wrote a great book, a science fiction novel. (Elaboration)

This kind of discourse information can subtly influence the understanding of an utterance. The appositive clause in (24), for example, not only elaborates the main clause, it also eliminates a possibility left open by the information conveyed by the main clause: that the professor is unknown or not especially prominent in any way.

- (24) A professor, a famous one, is coming to give a talk. (Elaboration)

The examples in (25) show that appositives participate in even more exotic types of rhetorical relations with main clauses. (25a) and (26a) are infelicitous in “out of the blue” contexts. An addition of an appositive clause, however, saves these sentences, as shown in (25b) and (26b).

- (25) a. ?John is also a good tennis player. (in null context)
 b. John, a good swimmer, is also a good tennis player. (Parallel)
 (26) a. ?John is not a good tennis player, however. (in null context)
 b. John, a swimmer, is not a tennis player, however. (Contrast)

Also and *however* signal particular discourse relations – *Parallel* and *Contrast* respectively – as well as introducing certain presuppositions. The appositives in (25b) and (26b) satisfy the presuppositional and discourse structural requirements of the main clauses. This phenomenon challenges the assumption that main clauses in ACSs can always survive independently from appositive clauses.

3.4 The Projection Problem

One fact in support of the independence assumption is that the content of nominal appositives projects out of conditionals and intensional contexts. For example, as argued in Asher (2000), (27a) does not entail (27b) because the content of the nominal appositive in (27a) projects out of the antecedent of the conditional.

- (27) a. If the party, an uninteresting social gathering, is over, then we should find some where else to get a drink.
 b. If the party is over and the party is an uninteresting social gathering, then we should find some where else to get a drink.

The projection of appositive content in these contexts supports the independence assumption, if the appositive content *always* projects. This is not always the case, however. If the antecedent of the appositive is presuppositional, i.e. a proper name or definite description, the appositive content will project, otherwise, it need not do so. For example, the appositive content projects out in example (28a) but does not do so in (28b).

- (28) a. If John, a famous professor, publishes a book, he will make a lot of money.
 b. If a professor, a famous one (that is), publishes a book, he will make a lot of money.

Similar phenomena are encountered with respect to intensional contexts. On the *de re* readings of (29a) and (29b), the content of the appositive is interpreted outside of the intensional context, but not on the *de dicto* reading.

- (29) a. Mary wants to marry an Italian, a rich one.
 b. John believes that a professor, a quite famous one, published a new book.

The nominal appositive plays a special role with respect to the *de dicto* reading of (29a) and (29b); namely, it cancels a possibility left open by the main clause, just as in (24). For example, the *de dicto* reading of the main clause in (29a) is true in a situation in which Mary wants to marry any Italian regardless of whether he is rich or poor. However, poor Italians are disallowed by the appositive in (29a).

The discourse contribution of an nominal appositive may affect its projection behavior. For example, if the appositive in (30) is understood as introducing background information, i.e. as saying that an A is a good grade, then it projects out of the conditional, but if it is interpreted as an elaboration, i.e. that John wants a good grade and the grade is an A, then it does not project out.

(30) If John gets a good grade, an A, in his logic class, then he will be happy.

Appositive content also projects out if the appositive is interpreted generically, as in (31).

(31) A wolf, a ferocious animal, might come into your house.

One challenge associated with the generic reading of nominal appositives is that it co-exists only with the *de dicto* reading (and not the *de re* reading) of the main clause. If the appositive content in (31) is understood as providing background to the main clause content, then the appositive content projects out and receives a *de re* reading. If the appositive content in (31) is understood as providing further elaboration of the main clause content, then the appositive content does not project out and receives a *de-dicto* reading. So the NP antecedent to the appositive must play dual semantic roles. It must be interpreted generically in order to support the generic reading of the appositive, but, at the same time, it must be interpreted as a nonspecific indefinite within the main clause. Potts (2005: 102) makes a similar point.

Finally, the generic reading may be blocked by informative particles or certain adverbs. For example, a generic reading of the nominal appositive does not seem to be available in (32a). The generic reading is also unavailable in (32b) where the appositive has a specific antecedent.

- (32) a. A certain wolf, a ferocious animal, might come into your house.
 b. A wolf, a really ferocious animal, might come into your house.

In summary, accounting for the projection of appositive content requires consideration of following factors: the presuppositions of both the appositive and its antecedent, whether the antecedent receives a specific or non-specific interpretation, the discourse contribution of the appositive, and whether the appositive has a generic interpretation. A simple minded viewpoint on projection cannot account for the examples above.

How might we go about accounting for the facts? We have a programmatic suggestion about how to do so. The thing to note is that the behavior of the appositive with respect to projection depends on anaphoric binding (in a broad sense including presupposition, cf. Geurts 1999). They must be interpreted so that their presuppositions are bound—so if the appositive includes, for instance, a variable that is bound by a (nonprojecting) host indefinite, it cannot project, but if the main clause contains a presupposition that would remain unbound if the appositive did not project, it must do so. This idea can be made precise using anaphoric notions of presupposition (e.g. Geurts 1999) and a notion of maximization of variable binding (cf. the *Maximise Discourse Coherence* of Asher & Lascarides 2003). We will not be able to make this idea more precise here for space reasons, but leave it as an avenue for future work.

4 Appositive Relative Clauses

When appositive relative clauses are brought into the discussion, the complexity of the phenomena introduced in section 3 increases. In this section we show that appositive relative clauses differ substantially from nominal appositives, contra the claims made in del Gobbo (2003) and Doron (1994) and described in section 2.2.

First, appositive relative clauses affect the interpretation of main clauses differently than nominal appositives. Only a *de re* reading is available in (33a) but both *de re* and *de dicto* readings are available in (33b).

- (33) a. John wants a car, which is red. (*de-re* only)
 b. John wants a car, a red one. (*de-re* and *de-dicto*)

Second, appositive relative clauses make more varied contributions to discourse than nominal appositives: *Explanation* (34b) in addition to *Background* and *Elaboration*. An nominal appositive, for example, cannot be understood as providing an explanation of the main clause, cf. (35b).

- (34) a. Kim entered the room, which was pitch dark.
 (Background)
 b. Kim turned on the light of the room, which was pitch dark.
 (Explanation)
- (35) a. Kim entered the room, a pitch dark one. (Background)
 b. Kim turned on the light of the room, a pitch dark one.
 (Explanation: ?, Background: ok)

Appositive relative clauses can easily trigger the projection of appositive content in (36b). This may be caused by the definiteness associated with the relative pronoun.

- (36) a. John believes that a professor, a quite famous one, published a book.
 (*de-re* and *de-dicto*)
 b. John believes that a professor, who is quite famous, published a book.
 (*de-re* only)

Finally, appositive relative clauses seem to block generic interpretations in examples like (37).

- (37) A wolf, which is a ferocious animal, might come into your house.

In sum, relative appositive clauses behave very differently from nominal appositives, contradicting the claim in the literature that they are identical, and ruling out any analysis that treats the two as mutually paraphrasable (such as that of del Gobbo 2003).

5 Concluding Remarks

This short paper shows that appositive content and main clause content can interact with each other in the process of interpretation, and appositive relative clauses and nominal appositives interact with main clauses in very different ways. Some further work needs to be done in order to account for this interaction. First, the syntax-semantics interface of appositives needs to be reconsidered. Naive independent clause approaches and naive subordinate clause approaches cannot capture the complicated interaction between appositive clauses and main clauses. Second, the semantic relationship between appositive content and main clause content is more complicated than simply background information or a conventional implicature in Potts' sense. A more complicated account of discourse relations is required to account for the interaction of appositive and main clause content.

References

- Asher, N. (2000), "Truth Conditional Discourse Semantics for Parentheticals," *Journal of Semantics*, **17**: pp. 31-50.
- Asher, N. and A. Lascarides. (2003), *Logics of Conversation*. Cambridge, UK.: Cambridge University Press.
- Chierchia, G., and S. McConnell-Ginet. (1993), *Meaning and Grammar*. Cambridge, Mass.: MIT Press.
- Dever, J. (2001), "Complex Demonstratives," *Linguistic and Philosophy*, **24**: pp. 271-330.
- Doron, E. (1994), "The Discourse Function of Appositives," in *Proceedings of IATL 9*.
- Geurts, B. (1998), *Presuppositions and Pronouns*. Amsterdam: Elsevier Press.
- del Gobbo, F. (2003), *Appositives at the Interface*. Dissertation, UC Irvine.
- Karttunen, L. and S. Peters. (1979), "Conventional Implicatures in Montague Grammar," *Syntax and Semantics 11: Presupposition*: pp. 1-56.
- Potts, C. (2005), *The Logic of Conventional Implicatures*. Oxford: Oxford University Press. Revised version of 2003 UCSC dissertation.
- Sells, P. (1985), *Restrictive and Non-Restrictive Modification*, (CSLI-85-28): Center for the Study of Language and Information.

EXPLETIVES MOVE!

Masashi Nomura

University of Connecticut

This paper develops the theory of Agree proposed by Chomsky (2000, 2001a, b), showing that expletives *there* and *it* are base-generated in the Spec of vP/VP , respectively. By so doing, I argue that the residue of Spec-Head agreement can be dispensed with; hence, we eliminate the conditions on Agree specific to expletives.

1 AGREE

Chomsky (2000, 2001a, b) proposes that instead of agreement and feature checking being instantiated by ATTRACT (Chomsky 1995), which results in the matching features moving upward to the attractor, there is simply the operation AGREE, with no movement involved at all. Under the theory of AGREE, uninterpretable features of a probe α and a goal β are valued under the structural relation (1), subject to the conditions in (2).

- (1) AGREE (cf. Chomsky 2000, 2001a, b)



AGREE (α , β), where α is a probe P and β is a matching goal G, '>' is a c-command relation and uninterpretable features of α and β are valued.

- (2) **Conditions on AGREE** (cf. Chomsky 2000:122)
- a. Matching is feature identity.
 - b. D(P) (Probe domain) is the sister of P.
 - c. Locality reduces to 'closest c-command'.
 - d. P and G must be active (they must have uninterpretable feature(s)).

Chomsky (2001b) argues that expletive EXPL directly merges in the Spec of TP from the numeration, assuming that EXPL must delete the EPP-feature of T (in Chomsky 2001b, the occurrence (OCC) feature) and lose its own uninterpretable features (possibly structural Case, as proposed by Lasnik 1999). As we can see in (2), the condition in (2b) excludes an AGREE relation between a head H and an element in the Spec of HP if T is a probe and EXPL is its goal. Supposing

EXPL is a simple head, not formed by Merge, Chomsky claims that in Collins's (2001) label-free system EXPL is accessible without search as a probe, and can match and agree with the goal T. This means that Chomsky still needs the "Spec-Head configuration" limited to EXPL in the theory of AGREE as an exceptional condition. This looks anomalous and I will propose that it is not needed even for EXPL. One leading idea of the Minimalist Program is to eliminate individual conditions and reduce them into more general principles. In order to eliminate the conditions on AGREE specific to expletives, I would like to closely examine two types of constructions with an expletive and see if expletives need to be base-generated in the Spec of TP.

2 Merge over Move versus Move over Merge

Given a construction with an expletive and at least two NP-movement predicates, sometimes the NP obligatorily occurs in the lowest position as in (3) and sometimes the NP occurs in the highest position below the expletive as shown in (4).

(3) "EXPL ... e ... NP"

- a. There_i seem [_{TP} t_i to be unicorns in the garden].
- b. *There seem [_{TP} unicorns_j to be t_j in the garden].

(4) "EXPL ... NP ... e"

- a. [_{TP} It seems that [_{TP} John_j was told t_j that the world is round]].
- b. * [_{TP} John_j seems that [_{TP} it was told t_j that the world is round]].
- c. * [_{TP} It was told John that the world is round].

The first pair of examples has been argued to motivate a preference for Merge over Move, the second one for Move over Merge. The second group of examples also illustrates the fact that an *it* expletive cannot occur in the passive of double-object constructions. In this section, I show arguments for Merge over Move and Move over Merge, respectively.

As described here, the examples in (3) and (4) seem to lead to mutually incompatible conclusions, given that one seems to show immediate merge of an expletive and the other to show late merge. Thus, questions in this section are: (i) Do expletives need to be base-generated in the Spec of TP? (ii) Are both expletives *there* and *it* generated in the same syntactic position? (iii) Do we need the Merge vs. Move account at all?

2.1 Merge over Move account

Chomsky (1995, 2000) proposes Merge over Move: Merge is preferred over Move. According to Chomsky, at the point at which the embedded clause in (3) is built, we can either insert *there* or move *unicorns* to the embedded subject position. Chomsky argues that the former option is preferable. Under Merge over Move, if there is an expletive in the numeration then that has to get merged as soon as there is a slot for it. This easily accounts for the examples in (3). However, this account immediately faces with the problem to explain the examples in (4) since it does not allow *John* to merge into the Spec of TP and in fact forces *it* to merge into that position.

Chomsky (2000) introduces the concept of subnumeration, defined on phases (each phase (CP, v*P) has its own subnumeration). Given that an expletive is not in subnumeration 1 where we generate an embedded sentence *that John was told that the world is round*, only *John* is the element that can merge into the Spec of TP by Move as in (5c).

- (5) a. [CP₃ It seems [CP₂ that John was told [CP₁ that the world is round]]]
 NUMERATION (CP₃) : {it, seems, {that, John, was, told, {that, the, world, is, round}}}
 SUBNUMERATION 1 (CP₂) : {that, John, was, told, {that, the, world, is, round}}
 SUBNUMERATION 2 (CP₁) : {that, the, world, is, round}
 b. [CP₁ **that the world is round**] + {it, seems, {that, John, was, told}}
 c. [CP₂ **that** [TP **John_j was told t_j** [CP₁ that the world is round]]]
 + {it, seems}
 d. [CP₃ [TP **It seems** [CP that [TP John_j was told t_j [CP that the world is round]]]]]

Thus, by introducing the notion of phases, Chomsky maintains the Merge over Move account for the two types of constructions with an expletive.

2.2 Remaining question for Merge over Move account

There is a remaining question for the Merge over Move account. Remember that Chomsky (2001b) assumes that an expletive directly merges in the Spec of TP from the numeration. If this is the case, we predict that (4c) is grammatical. Under Chomsky's system, T AGREES with *John* and values nominative Case to it. And then *it* is merged into the Spec of TP and the sentence should converge. Yet it is ungrammatical. Hence, this problem must be solved.¹

2.3 Move over Merge account

There is an alternative approach which is Move over Merge: Move is preferred over Merge (cf. Shima 2000). Under this approach, (4) is straightforward but not

(3). In order to account for examples like in (3), it is proposed that the expletive *there* has a Case feature, and a postcopular NP is optionally assigned “partitive” Case by a copula and now an associate is assigned “partitive” Case, therefore it does not have any motivation to move into the Spec of TP.^{2,3}

2.4 Remaining question for Move over Merge (Partitive Case)

We have a couple of questions with respect to “partitive” Case. Let’s consider the transitive expletive constructions in Icelandic.

- (6) Það hafa margir jólasveinar borðað búaðinginn.
 there have many Christmas-trolls eaten the pudding
 ‘Many Christmas trolls have eaten the pudding.’ (Jonas 1996:2)

If we extend the idea of “partitive” Case into Icelandic example like (6), it is difficult to see what the “partitive” Case assigner of *margir jólasveinar* is in (6). Moreover, in Icelandic the associates can be realized as nominative, accusative, or dative as in (7) – (9).

- (7) Það höfðu verið keyptir þrjár stólar á uppboðinu.
 there had(3PL) been bought three chairs(NOM) at the auction
 (Sigurðsson 1992:22)
- (8) Við teljum koma marga íslendinga/*margir íslendingar
 we(NOM) believe(1PL) come many Icelanders(ACC/*NOM)
 ‘We believe there to come many Icelanders’ (Taraldsen 1995:322)
- (9) Það virðist einhverjum manni hestarnir vera seindir
 there seemed(3SG) some man(DAT) the horses(NOM) be slow
 ‘It seems to some man that the horses are slow’
 (Holmberg and Hróarsdóttir 2002:147)

Thus, it seems that Case of the associates is not “partitive Case” in Icelandic. If the associates in English are not assigned “partitive” Case either, then the Move over Merge account does not hold. The account must capture the fact that the NP associate of the expletive bears whatever case the subject would have in a non-expletive construction.

3 Accounts for the Syntax of Expletives

3.1 *There, it*, and agreement (McCloskey 1991)

If expletives have an uninterpretable feature (e.g. structural Case-feature), they must have a special condition on AGREE (e.g. Spec-Head agreement: no c-command relation necessary to value the Case-feature of expletives). As we have seen in section 2.2, it is wrongly predicted that (4c) is grammatical. Moreover, McCloskey (1991) observes that *there* does not exhibit agreement with T while *it* does show agreement as exemplified in (10) and (11).

- (10) a. No solutions exist for this problem.
 b. There exist no solutions for this problem.
 c. *There exists no solutions for this problem.
 (cf. McCloskey 1991:563)
- (11) a. That he'll resign and that he'll stay in office seem at this point
 equally possible
 b. *It seem at this point equally possible that he'll resign and that he'll
 stay in office
 c. It seems at this point equally possible that he'll resign and that he'll
 stay in office
 (cf. McCloskey 1991:564-565)

Under Chomsky's system, *it* directly merges into the Spec of TP from the numeration. If this is the case, we predict that (11b) is grammatical but (11c) is not. In this system, T AGREES with an element that is c-commanded by T and values nominative Case to it. And then *it* is merged into the Spec of TP and the sentence should converge. This means that T does not show agreement with *it*, contrary to facts. Thus, we can conclude that *it* cannot directly merge into the Spec of TP from the numeration, contrary to what Chomsky (2000, 2001a, b) assumes.

3.2 Proposal: Expletives move!

In this paper, I propose that expletives do not merge into the Spec of TP (contra Chomsky 2000, 2001a, b). Given that, I claim that (a) *there* merges into the Spec of *v*P, (b) *it* merges into the Spec of VP. As a consequence of this proposal, we eliminate conditions on AGREE specific to expletives; hence only conditions on Agree in (2) apply and we also eliminate Merge over Move vs. Move over Merge preference issue.

3.3 Account for the syntax of *there*

On the assumption that *there* merges into the Spec of *v*P, the examples in (3) now have structures as in (12).

- (12) a. [_{TP} There_i [_{VP} seem [_{TP} t_i to [_{VP} t_i be unicorns in the garden]]]]
 b. * [_{TP} There [_{VP} seem [_{TP} unicorns_j to [_{VP} t_j be t_j in the garden]]]]

Thus, (12b) is ungrammatical because *there* does not merge into the Spec of *vP*; hence (12b) is not derivable because the Spec of TP is not a position where *there* can merge by the assumption. (12a), on the other hand, is grammatical since *there* merges into the Spec of *vP* and T does not fully AGREE with *there*, but it seeks a further goal (an associate DP) and AGREES with *someone*, by the Maximization Principle (Chomsky 2001a:15): Maximize matching effects.

Now, consider the examples in (13).

- (13) a. There have been some books_i put t_i on the table.
 b. *There have been put some books on the table.

Under the Agr-less Case theory, the possible landing site of *some books* is the Spec of VP (cf. Johnson 1991). Thus, the structures of (13) should be like (14).

- (14) a. There_i have [_{VP} t_i been [_{VP} some books_j put t_j on the table]].
 b. *There_i have [_{VP} t_i been [_{VP} __ put some books on the table]].

(14b) implies that an object DP moves to the Spec of VP for EPP reasons.⁴ By the assumption that *there* merges into the Spec of *vP*, the only element that can go into that position here is *some books*.

3.4 Account for the syntax of *it*

The account for the syntax of *it* is very straightforward.

- (15) a. *It was told John that the world is round.
 b. John was told that the world is round.

As we have seen this contrast in (4), *it* expletive cannot occur in the passive of double-object constructions. The structures of (15) should be like (16). Here, I assume that in double object constructions, a head X assigns Case to its complement.^{5, 6} In (16a), T fully AGREES with *it* so that *John* does not get nominative Case. Moreover, *John* cannot be assigned Case by X, assuming that X assigns Case to its c-commanding element; therefore John never gets Case, and hence the derivation crashes. In (16b), on the other hand, there is no *it* between T and *John*; hence John moves up to the Spec of *vP*, T *Agrees* with *John* and the derivation converges.

- (16) a. * [_{TP} It_i T [_{VP} t_i was [_{VP} t_i told [_{XP} John that the world is round]]]].

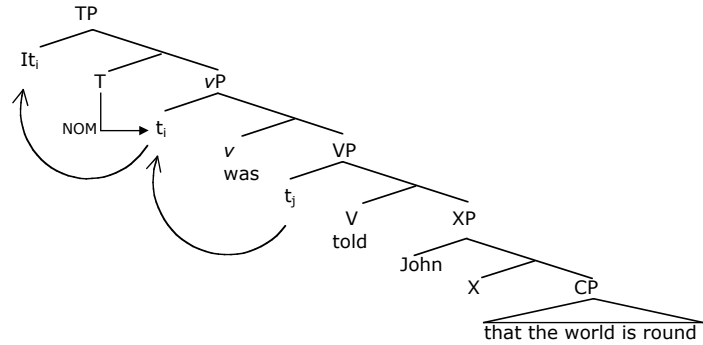

- b. [_{TP} John_i T [_{VP} t_i was [_{VP} t_j told [_{XP} t_i that the world is round]]]]].

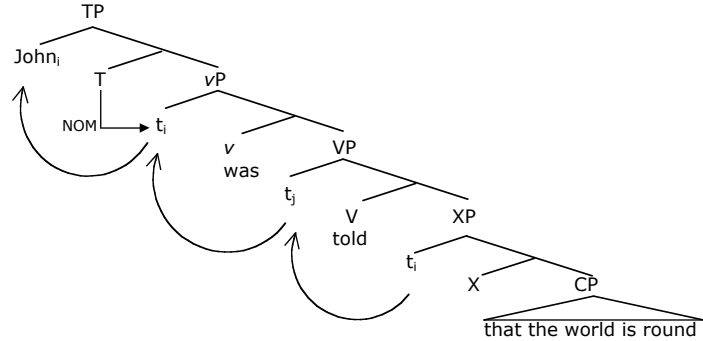

4. Evidence: *There* in the Spec of vP, *It* in the Spec of VP

In this section, I will give a piece of evidence that *there* merges in the Spec of vP and *it* merges in the Spec of VP.

4.1 Existential Constructions in English and Italian

Since Burzio (1986), it has been observed in the literature that there is a contrast between English and Italian in existential constructions as shown in (17) and (18).

- (17) a. There've been some men arrested.
 b. *There've been arrested some men.
- (18) a. *Sono stati alcuni uomini arrestati.
 are been some men arrested

- b. Sono stati arrestati alcuni uomini.
are been arrested some men

(Caponigro and Schütze 2003:293)

There are two possible solutions to explain this contrast under my analysis: (a) V requires satisfying the EPP in English but it doesn't in Italian. (b) Passive participles in Italian overtly undergo V-to-v Head-movement. Either account is compatible with our analysis so that I will not take a stand here.

Let's consider the first case. The structures of (17a) and (18b) are shown in (19) and (20), respectively.

- (19) English: There have been some men arrested

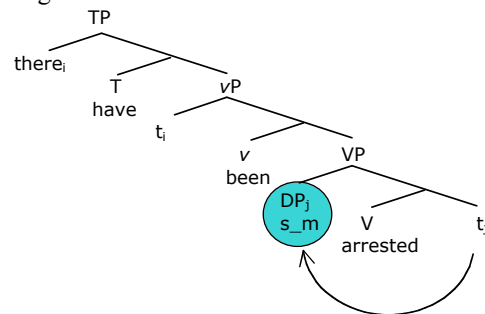

- (20) Italian: Sono stati arrestati alcuni uomini

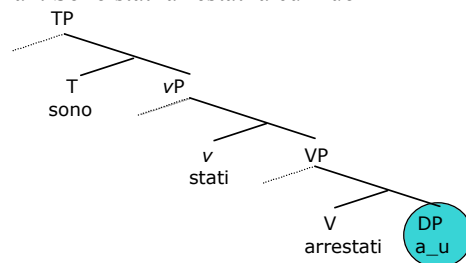

As we have seen in (14), English seems to require an object to move to the Spec of VP and so as in (19), while Italian seems not to have such a requirement as in (20). The contrast between (17) and (18) can be accounted for by the nature of the EPP in the two languages.

The second possible explanation to the contrast between English and Italian in the existential constructions is that although both English and Italian require an object to move to the Spec of VP, passive participles in Italian overtly undergo V-to-v Head-movement, while those in English don't. This is supported by the fact that English allows having an adverb such as *unlawfully*, *brutally* in

between, but Italian does not allow having an adverb such as *illegalmente* (unlawfully), *bruscamente/rudemente* (brutally), *bene* (well) in between.

- (21) a. There have been some men {**unlawfully arrested** / **brutally beaten**}.
 b. Some men have been {**unlawfully arrested** / **brutally beaten**}.
- (22) a. *Sono stati **illegalmente** arrestati alcuni uomini.
 are been unlawfully arrested some men
 b. *Alcuni uomini sono stati **illegalmente** arrestati.
 some men are been unlawfully arrested
 c. Alcuni uomini sono stati arrestati **illegalmente**.
 some men are been arrested unlawfully
- (23) a. *Sono stati **bruscamente/rudemente** colpiti alcuni uomini.
 are been brutally hit some men
 b. *Alcuni uomini sono stati **bruscamente/rudemente** colpiti.
 some men are been brutally hit
 c. Alcuni uomini sono stati colpiti **bruscamente/rudemente**.
 some men are been hit brutally
- (24) Questo genere di spettacoli è sempre stato <*bene> recensito <bene>
 this kind of shows is always been well reviewed well
 dalla critica.
 by-the critics
 ‘This kind of show has always been reviewed positively by the critics.’
 (Caponigro and Schütze 2003:298)

However, adverbs such as *certo*, *certamente* can appear between *stati* and *arrestati* as shown in (25) and (26).

- (25) a. Sono stati **certo** arrestati alcuni uomini.
 are been certainly arrested some men
 b. Alcuni uomini sono stati **certo** arrestati.
 some men are been certainly arrested
- (26) a. Sono stati **certamente** arrestati alcuni uomini.
 are been certainly arrested some men
 b. Alcuni uomini sono stati **certamente** arrestati.
 some men are been certainly arrested

Although it appears that Head-movement solution is not hold, Andrea Calabrese (personal communication) pointed out that "certamente" seems to have the

interpretation of a parenthetical in the sense that it is a modifier of the utterance or the entire speech act.⁷

As we have shown above, either account requires an object to move to the Spec of VP in English. In other words, *there* must not merge into the Spec of VP. Given that the Spec of TP is too high for *there* to merge and the Spec of VP is too low, we conclude that *there* merges into the Spec of vP.

4.2 *It* and clausal arguments

In contrast to NP arguments, clausal arguments do not need Case (cf. Stowell 1981). As is obvious in (27), in contrast to an NP argument, a clause can function as an argument of an adjective, which does not assign Case.

- (27) a. I am afraid that John will leave me
 b. *I am afraid John (Bošković 1995:32)

Clauses can also function as complements of verbs that do not assign accusative Case.

- (28) a. John remarked that she left
 b. *John remarked her leaving
- (29) a. It seems that she left
 b. *It seems her leaving (cf. Bošković 1995:32)

Interestingly, *It* can appear in the object position and discharges the accusative Case of the verb, leaving the true object argument Caseless (cf. Postal and Pullum 1988, Authier 1991, Bošković 1995).

- (30) a. People widely believe that the earth is round.
 b. ?People widely believe it that the earth is round.

- (31) The structure of (30b)

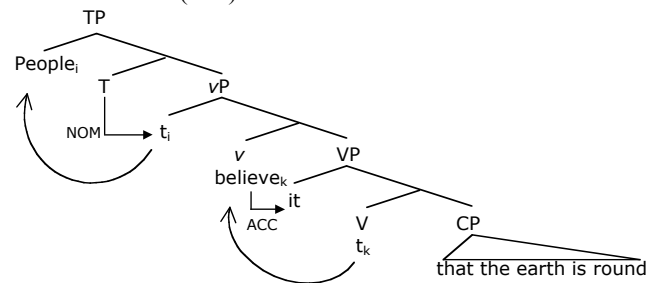

(30b) supports the proposal that *it* merges into the Spec of VP, given that a clausal argument can be Caseless.

Bošković (1995) argues that clauses need Case when they move to subject position (cf. Kuno 1973, Koster 1978, Delahunty 1983).⁸

- (32) a. That the earth is round is widely believed
 b. It is widely believed that the earth is round

(33) The structure of (32a)

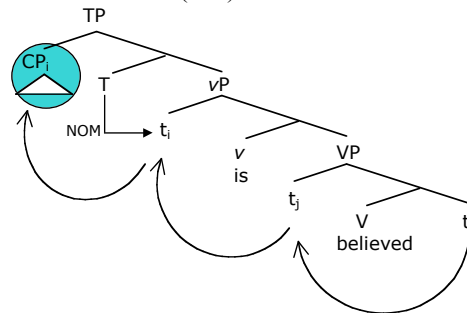

(34) The structure of (32b)

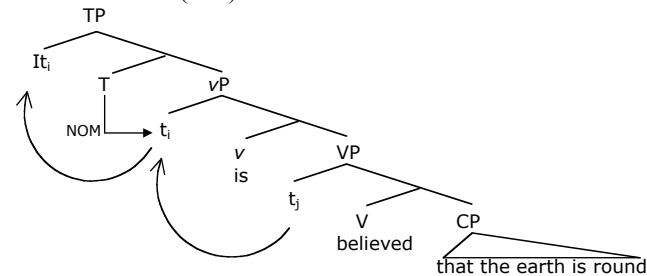

On the proposal that *it* merges into the Spec of VP, grammaticality of (32) is correctly captured, given that clausal arguments need Case when they move to subject position while they can be Caseless when *it* appears with them as shown in (33) and (34).

If *it* merges into the Spec of VP and discharges accusative Case (when the sentence is active) or nominative Case (when the sentence is passive), then it is predicted that *it* cannot appear in the double object constructions. This prediction is borne out.

- (35) a. John told/taught the students that the earth was round.
 b. *John told/taught the students it that the earth was round.

- c. *John told/taught it the students that the earth was round.
 d. *It was told/taught the students that the earth was round.
 e. The students were told/taught that the earth was round.

(36) The structure of (35a)

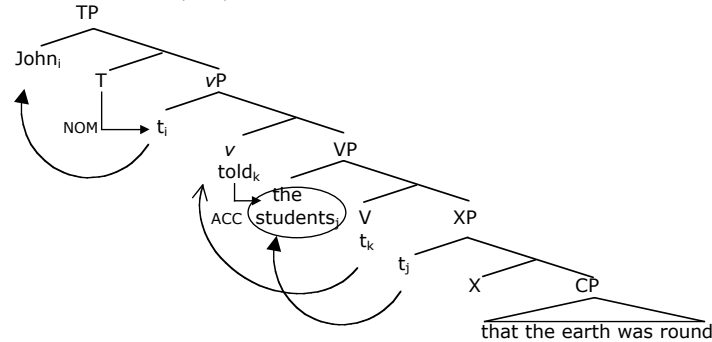

(37) The structure of (35c)

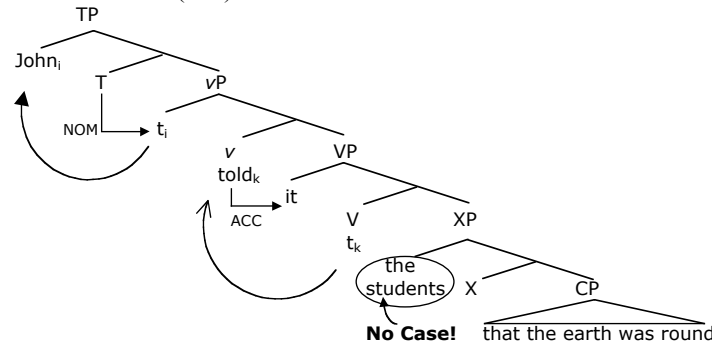

Ungrammaticality of (35b, c, d) is accounted for if *it* merges into the Spec of VP. As in (37), an indirect object *the students* cannot get any Case because *it* is valued accusative Case and X does not assign Case to an element in the Spec of XP. Thus, this strongly supports the conclusion that *it* merges into the Spec of VP. Hence, *there* and *it* have different syntactic base-positions.

5 Conclusion

To summarize, I eliminate a special condition on AGREE for expletives. As its consequences, we conclude that *there* merges into the Spec of vP, while *it* merges into the Spec of VP. In addition to these consequences, we show that an NP object with an uninterpretable feature must move into the Spec of VP in

English. As observed in section 2, we show a Merge over Move vs. Move over Merge issue. My analysis leads us to the conclusion that we need neither preference as an economy condition.

ACKNOWLEDGEMENTS

I would like to thank Jonathan David Bobaljik, Željko Bošković, and Howard Lasnik for their very detailed comments on the present study. I am very grateful to Brian Agbayani, Mark Baltin, Andrea Calabrese, Sarah Felber, Heidi Harley, Kyle Johnson, Diane Lillo-Martin, Nobuhiro Miyoshi, Fumikazu Niinuma, Bum-Sik Park, Yael Sharvit, and William Snyder, and the participants of the WECOL 2003 for valuable discussions, comments, and questions. I would also like to thank Klaus Abels and Shoichi Takahashi for discussions at an earlier stage of this material. The usual disclaimers apply.

NOTES

¹ In this paper, I assume that CP does not need case. See section 4.2.

² In this view, it is assumed that a Case-feature of the expletive can be satisfied under the Spec – Head configuration independently of φ -agreement.

³ Here, “partitive” Case is in the sense of Belletti (1988), Bošković (2002a, 2002b), Lasnik (1992, 1995), and Shima (2000) only for NP-associates of the expletives. Therefore, it is different from partitive Case in Latin, Russian, Finish, etc.

⁴ This is very reminiscent of Lasnik (1995) under the Agr-based Case theory.

⁵ I assume that X assigns Case under AGREE so that AGREE relation between a head X and an element in the Spec of XP is excluded but I do not take a stand on whether the Case by X is structural or inherent.

⁶ In Beck and Johnson (2004), the head X is the source of HAVE part to the meanings in the double object frame. In Johnson (1991), XP is posited to be a kind of DP, and in Pesetsky (1995), it is PP. Its syntactic category is not important for our purposes here.

⁷ However, still they do not seem to him to be pronounced like other parenthetical expressions.

⁸ Koster (1978) argues that sentential subjects don't exist, while Delahunty (1983) argues that they do. See also Kuno (1973) who discusses sentential subjects in detail.

REFERENCES

- Authier, J.-Marc. 1991. V-governed expletives, Case theory, and the Projection Principle. *Linguistic Inquiry* 22:721-740.
- Beck, Sigrid, and Kyle Johnson. 2004. Double objects again. *Linguistic Inquiry* 35:97-124.
- Belletti, Adriana. 1988. The Case of unaccusatives. *Linguistic Inquiry* 19:1-34.
- Bošković, Željko. 1995. Case properties of clauses and the Greed Principle. *Studia Linguistica* 49:32-53.
- Bošković, Željko. 2002a. A-movement and the EPP. *Syntax* 5:167-218.
- Bošković, Željko. 2002b. Expletives don't move. In *NELS* 32, 21-40.
- Burzio, Luigi. 1986. *Italian syntax*. Dordrecht: Reidel.
- Caponigro, Ivano, and Carson Theodore Robert Schütze. 2003. Parameterizing passive participle movement. *Linguistic Inquiry* 34:293-308.
- Chomsky, Noam. 1995. *The minimalist program*. Cambridge, Mass.: MIT press.

- Chomsky, Noam. 2000. Minimalist inquiries: The framework. In *Step by step: Essays on minimalist syntax in honor of Howard Lasnik*, eds. Roger Martin, David Michaels and Juan Uriagereka, 89-155. Cambridge, Mass.: MIT Press.
- Chomsky, Noam. 2001a. Derivation by phase. In *Ken Hale: A life in language*, ed. Michael Kenstowicz, 1-52. Cambridge, Mass.: MIT Press.
- Chomsky, Noam. 2001b. Beyond explanatory adequacy. MIT Occasional Papers in Linguistics 20. Cambridge, Mass.: MIT, Department of Linguistics and Philosophy, MITWPL.
- Collins, Chris. 2001. Eliminating labels. MIT Occasional Papers in Linguistics 20. Cambridge, Mass.: MIT, Department of Linguistics and Philosophy, MITWPL.
- Delahunty, Gerald P. 1983. But sentential subjects do exist. *Linguistic Analysis* 12:379-398.
- Holmberg, Anders, and Thorbjörg Hróarsdóttir. 2002. Agreement and movement in Icelandic raising constructions. *Working Papers in Scandinavian Syntax* 69:147-168.
- Johnson, Kyle. 1991. Object positions. *Natural Language and Linguistic Theory* 9:577-636.
- Jonas, Dianne Elizabeth. 1996. Clause structure and verb syntax in Scandinavian and English. Doctoral dissertation, Harvard University, Cambridge, Mass.
- Koster, Jan. 1978. Why subject sentences don't exist. In *Recent transformational studies in European languages*, ed. Samuel J. Keyser, 53-64. Cambridge, Mass.: MIT Press. [hadcopy].
- Kuno, Susumu. 1973. Constraints on internal clauses and sentential subjects. *Linguistic Inquiry* 4:363-385.
- Lasnik, Howard. 1992. Case and expletives: Notes toward a parametric account. *Linguistic Inquiry* 23:381-405.
- Lasnik, Howard. 1995. Case and expletives revisited: On Greed and other human failings. *Linguistic Inquiry* 26:615-633.
- Lasnik, Howard. 1999. *Minimalist analysis*. Cambridge, Mass.: Blackwell.
- McCloskey, James. 1991. There, it and agreement. *Linguistic Inquiry* 22:563-567.
- Pesetsky, David. 1995. *Zero syntax*. Cambridge, Mass.: MIT Press.
- Postal, Paul M., and Geoffrey K. Pullum. 1988. Expletive noun phrases in subcategorized positions. *Linguistic Inquiry* 19:635-670.
- Shima, Etsuro. 2000. A preference for Move over Merge. *Linguistic Inquiry* 31:375-385.
- Sigurðsson, Halldór Ármann. 1992. The case of Quirky subjects. *Working Papers in Scandinavian Syntax* 49:1-26.
- Stowell, Timothy. 1981. Origins of phrase structure. Doctoral dissertation, MIT, Cambridge, Mass.
- Taraldsen, Knut Tarald. 1995. On agreement and nominative objects in Icelandic. In *Studies in comparative Germanic syntax*, eds. Hubert Haider, Susan Olsen and Sten Vikner, 307-327. Dordrecht: Kluwer.

Masashi Nomura
 Department of Linguistics, Unit 1145
 University of Connecticut
 337 Mansfield Road
 Storrs, CT 06269-1145
 masashi.nomura@uconn.edu